



*Proximité - Conseil - Service*



ecotel

# 40 magasins au cœur de vos régions\*



Crédits photos :  
Bernard Plessy /  
Image & Associés  
- Dijon / Studio Blaak / Studio  
Plateforme / Jacques  
Caillaut / Fotolia /  
Studio Contre jour.

## Proximité - Conseil - Service

\*Voir liste au dos du catalogue

**9000** articles sur catalogue  
**4000** références en stock  
 **disponibilité** immédiate

**PROXIMITÉ**  
**CONSEIL**  
**SERVICE**



## NOS SERVICES



### PERSONNALISATION

- Sets et nappes en papier,
- Porcelaine,
- Verrerie,
- Vêtements professionnels,
- Plateaux,
- Porte menus.



### SERVICE APRÈS-VENTE

- Une **GARANTIE D'1 AN** sur le matériel électrique\*\*
  - Une **GARANTIE D'EBRECHURE de 5 ANS** sur certaines pièces de porcelaine
  - Un **SERVICE APRÈS VENTE** à votre écoute.
- \*\* (Pièces et main-d'œuvre, voir conditions générales de vente).



### FICHES DE DONNÉES DE SÉCURITÉ

Pour retrouver les fiches de sécurité des produits dangereux, rendez vous sur [www.quickfds.com](http://www.quickfds.com)  
 Renseignez votre nom et votre adresse électronique puis le nom de votre distributeur, vous aurez accès aux fiches des produits qui vous intéressent.



### LIVRAISON



Selon les modalités de votre magasin, Ecotel vous livre **GRATUITEMENT\***  
 Nous vous proposons également une **ASSISTANCE** dans la mise en place de votre matériel  
 \*à partir de 299€ HT de commande (hors mobilier).

L'équipe Ecotel est heureuse de vous accueillir dans ses magasins et showrooms pour vous conseiller et guider dans toutes vos réalisations

## PARTENAIRES



# Restez connecté à votre magasin ECOTEL

## www.ecotel.fr



Retrouvez

- ➔ Nos magasins
- ➔ Nos actualités
- ➔ Nos promotions
- ➔ Notre offre produit
- ➔ Nos publications

## Réservez en ligne vos produits



Connectez-vous sur  
[www.ecotel.fr](http://www.ecotel.fr)



Trouvez votre magasin  
de référence avec  
"store locator"



Faites votre  
sélection



Retirez en  
magasin



"Suivez-nous sur notre page Facebook"



# SOMMAIRE

4 MOBILIER

8 ART DE LA TABLE

10 vaisselle - le guide  
134 verrerie - le guide  
180 couverts - le guide  
206 accessoires de table  
230 bar  
246 buffet  
278 nappage

286 USAGE UNIQUE

331 CUISINE

332 stockage et manutention  
358 matériel électrique  
382 matériel de cuisson  
410 matériel de préparation

457 TRANSPORT DE REPAS

467 HYGIÈNE

501 VÊTEMENTS  
PROFESSIONNELS

519 HÔTELLERIE

536 INDEX

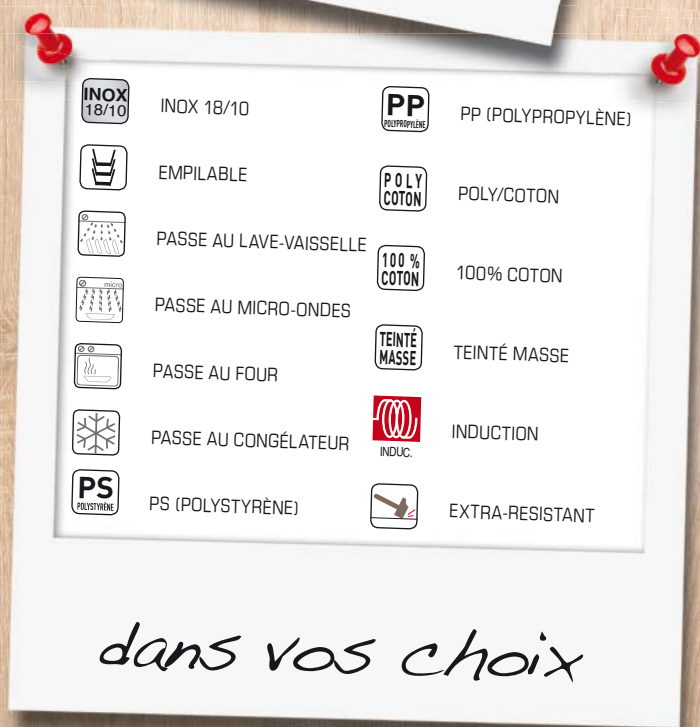



so.mob  
by  
ecotel

*Ambiance  
2018-2019*

## **Découvrez SO.MOB, notre marque de mobilier destinée aux cafés, hôtels et restaurants.**

Fort de notre savoir-faire de distributeur, nous avons élaboré avec soin une offre de produits et de services adaptée aux exigences des professionnels.

Nos conseillers techniques et notre service logistique sont à vos côtés pour vous accompagner dans vos projets.



so.mob



# NOS SHOW-ROOMS

Annecy



Aix en Provence



Fréjus



Nantes



St Etienne



Strasbourg



## Services

### Personnalisation

Notre offre de mobilier peut s'adapter à toutes vos contraintes et vos envies. Choix des couleurs, des matières, des dimensions... N'hésitez pas à nous consulter.

### Show-room

Nos espaces show-room sont à votre disposition pour apprécier le volume, les coloris, les matières de nos différents produits.

### Installation

Un service installation/montage est à votre disposition pour vous faciliter la mise en place de certaines pièces de mobilier dans votre établissement. Service sur devis.

### Service après-vente

Nous mettons à votre disposition les pièces détachées et accessoires nécessaires pour parer à l'usure des produits dans le temps.





### Fauteuil Montmartre Bamboo

Fauteuil en aluminium brillant. Assise et dossier en textilène 8 x 8 mm noir.

☐ x 10

**P.U.HT 92,00 €**

dont 0,07 € d'éco-contribution.

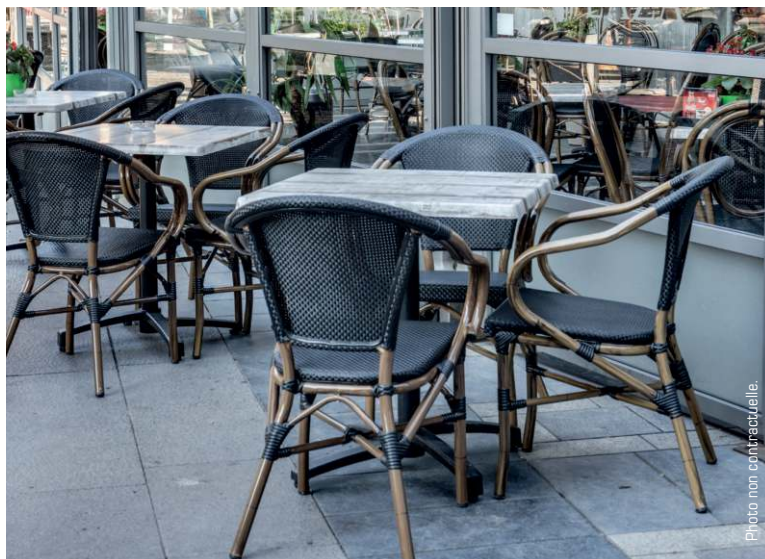

Photo non contractuelle.



### Plateau compact Redwood

Plateau en stratifié, épaisseur 12 mm. Chant en aile d'avion, âme noire. Système de fixation universel. Visserie fournie.

☐ x 2

**P.U.HT 66,00 €**

dont 0,42 € d'éco-contribution.



### Piètement Vérona

Piètement encastrable en aluminium. Plateau rabattable. Existe en mange debout.

☐ x 2

**P.U.HT 89,00 €**

dont 0,32 € d'éco-contribution.

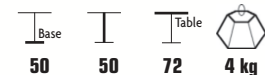

### Chaise Bastille

Structure en acier, peinture époxy. Ø tube 22 mm, épaisseur tube 1,5 mm.

☐ x 10

**P.U.HT 46,00 €**

dont 0,08 € d'éco-contribution.



Crédit photo: Les Amisités

### Chaise Lautrec

Structure en hêtre, teinte au choix. Assise et dos garnis revêtu de tissu Next coloris Light Grey.

☐ x 10

**P.U.HT 166,00 €**

dont 0,77 € d'éco-contribution.



### Chaise Floriane

Structure en hêtre teinté wengé. Assise et dossier garnis simili cuir Bordeaux 37.

☐ x 10

**P.U.HT 78,00 €**

dont 0,52 € d'éco-contribution.



Photo non contractuelle.



nouveau !

## Ariana

En bois massif. Design enrichi par de petites touches raffinées de métal. Surface utile plateau supérieur : 81 x 57cm. Livré monté.



A

Vitrine réfrigérée amovible Avec tiroir



B



C

Avec tiroir



Chariot de service

			P.U.HT	
A	1014115	3 niveaux - L. 102 x l. 57 x H. 84 cm - Noyer	x 1	1 317,00 €
B	1014116	2 niveaux - L. 102 x l. 57 x H. 120 cm - Gris	x 1	2 432,00 €
C	1014117	2 niveaux - L. 102 x l. 57 x H. 102 cm - Gris	x 1	2 324,00 €

Dont 2,64 € d'éco-contribution.

Dont 4,32 € d'éco-contribution.

Dont 3,36 € d'éco-contribution.

## Chariot Hira

Chariot 3 plateaux 89 x 47cm. Structure en tube rond chromé et étagères en bois mélaminé Noyer. 4 pare-chocs anti-traces et 4 roues Ø 100 mm pivotantes. Charge jusqu'à 100 kg répartis sur les 3 étages.



Chariot 3 niveaux

1004784 L. 103 x l. 54 x H. 92 cm  
Dont 1,68 € d'éco-contribution.

P.U.HT  
x 1 303,00 €

## Guéridon Auriga

Ligne de guéridons pour le service en salle Auriga. Guéridon 2 plateaux 80 x 40cm. Structure en tube carré chromé et étagères en bois mélaminé Noyer. 4 roues Ø 10 cm pivotantes.



Coloris disponibles, nous consulter



Guéridon 2 niveaux

1004788 L. 80 x l. 40 x H. 80 cm  
Dont 1,19 € d'éco-contribution.

P.U.HT  
x 1 226,00 €

## Tactus

Base de chariot de service en bois de grande qualité. Livré avec : - 2 tiroirs à fermeture douce - 1 plateau extractable en PE inclus. - 4 roues Ø 125 mm avec freins. Parties supérieures à sélectionner parmi une gamme complète (fromage, bar...). Surface utile : 93 x 53 cm.



La technologie ZEPE touch :

- Touché spécial chaud et doux. Finition mate.
- Traitement hydrophobique de haute technologie : nettoyage facile à l'eau.
- Bonne résistance aux hautes températures et au feu pour du bois.
- Excellente résistance à l'abrasion et aux tâches.



Table roulante 2 niveaux

66128 L. 99,5 x l. 53 x H. 80 cm  
Dont 3,85 € d'éco-contribution.

P.U.HT  
x 1 1 853,00 €

## Roma Wengé

Base de chariot de service en bois de grande qualité. Livré avec : - 1 plateau extractable en PE inclus. - 4 roues Ø 100 mm (existent avec frein en option). Parties supérieures à sélectionner parmi une gamme complète (fromage, bar...).

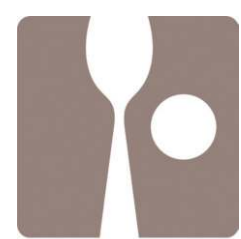

Table roulante 2 niveaux

61284 L. 106 x l. 52 x H. 80 cm  
Dont 2,10 € d'éco-contribution.

P.U.HT  
x 1 907,00 €





pro.mundi



## Pro Mundi

Des produits pros et beaux.

Pro. Mundi vous garantit la qualité professionnelle au meilleur prix dans l'univers des Arts de la Table.



# ART DE LA TABLE

<b>VAISSELLE - Le Guide .....</b>	<b>10</b>
<b>VERRERIE - Le Guide .....</b>	<b>134</b>
<b>COUVERTS - Le Guide .....</b>	<b>180</b>
<b>ACCESSOIRES DE TABLE.....</b>	<b>206</b>
<b>BAR .....</b>	<b>230</b>
<b>PLATEAUX .....</b>	<b>240</b>
<b>BUFFET.....</b>	<b>246</b>
<b>NAPPAGE TEXTILE .....</b>	<b>278</b>





Tendency > Page 90 Intensity > Page 90 Mekkano > Page 91 Louison > Page 93 Brush > Page 94 Restaurant > Page 95 Stairo > Page 96 Feston > Page 96



Splash > Page 61 Vital > Page 61 Artisan > Page 62 Sand > Page 64 Slate > Page 64 Coupe > Page 64



Ripple > Page 65 Jungle > Page 65 Brushwood > Page 65 Style > Page 66 Style ethnic > Page 66 Moving > Page 67



Frame > Page 67 Smooth > Page 67 Quadra > Page 68 Snack > Page 68 Brasserie > Page 69

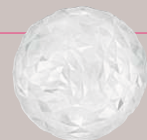

Diamond > Page 97



Savor > Page 14 Purity > Page 14 Sublime > Page 14 Water Pearl > Page 65 Fragment > Page 65 Holi > Page 17



Concrète > Page 17 Eternity > Page 17 Satinique > Page 18 Satinique Black > Page 19 Ginseng Black > Page 19 Ginseng Grey > Page 19



Bahia > Page 51



Technoplak > Page 59



Escale > Page 12 Onde > Page 12 Stone > Page 13



Canopée > Page 47



Teck > Page 48



Montmartre > Page 49



Vendôme > Page 50



Grand Chef > Page 50



Vaisselle régithermie > Page 97



Vaisselle incassable > Page 98



Vaisselle spécialités > Page 102



Vaisselle culinaire > Page 106



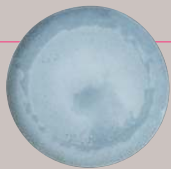

Sky > Page 73

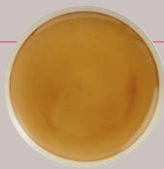

Winter > Page 74



Artic > Page 75



Linen > Page 75

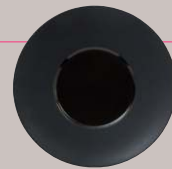

Chic et Mat > Page 76



Bistrot > Page 77



Grès couleur > Page 78



Saphir > Page 79



Rim > Page 80



Okito > Page 81



Twins > Page 81



Edina > Page 82



Folia > Page 83



Matcha > Page 83



Bambou > Page 83



Céleste > Page 83



Intemporel > Page 84



Roma color > Page 84



Veloutée > Page 92



Bamboo > Page 92



Métalfusion > Page 27



Néofusion > Page 28

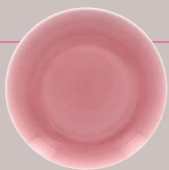

Vintage > Page 30



Mazza > Page 31



Woodart > Page 32

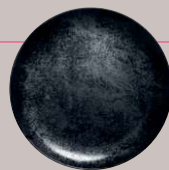

Karbon > Page 33

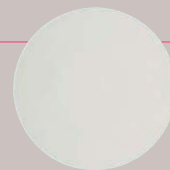

Allspice > Page 34



Aurée > Page 34



Fine dine > Page 35



Giro > Page 36



Gourmet > Page 37



Nano > Page 38



Anna > Page 39



Banquet > Page 40



Ondine > Page 42



Playa > Page 42



Métropolis > Page 43



Rondo > Page 43



Ska > Page 44



Moon > Page 45



Évolution > Page 45



Succession > Page 53

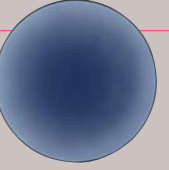

Equinoxe > Page 54



Arborescence > Page 55



Basalt > Page 56/57

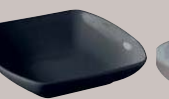

Club > Page 56/57



Solid > Page 58



Surface > Page 71



Blossom > Page 21



Modern Grace > Page 21



Pasta/Soup passion > Page 22



Artesano > Page 23



Sedona > Page 24



New Wave > Page 25



Bazik noir > Page 85



Ekta > Page 86



Classic square > Page 86



Célébration > Page 86



Bermudes > Page 87



Wing > Page 87



Roma > Page 88



Roma or > Page 88



K > Page 88



Ruby > Page 88



Hôtel > Page 89



Vénus > Page 89



Optima > Page 89



Bazik > Page 89



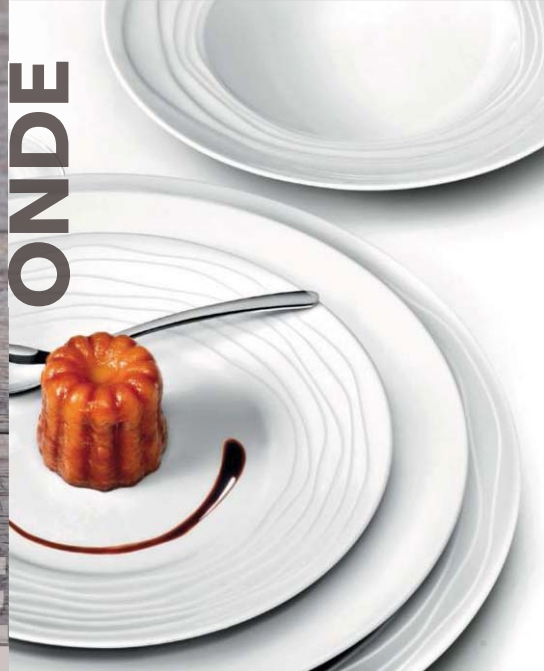

## ESCALE

En grès coloré de haute qualité. Les oppositions de mat et de brillant font ressortir le décor et accroche la lumière.

Noir

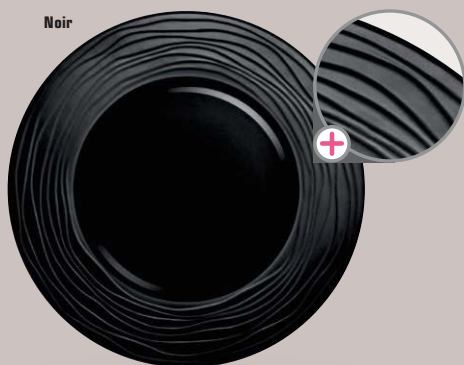

Gris

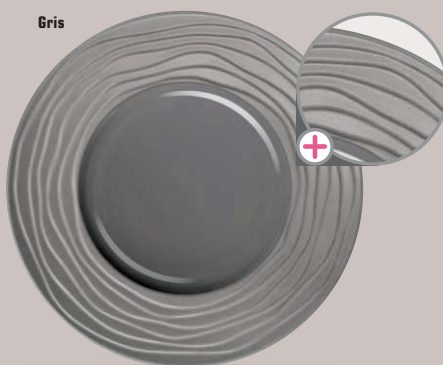

Assiette plate

<b>1005768</b>	∅ 31,5 cm	x 3
<b>1005769</b>	∅ 27,5 cm	x 6
<b>1005770</b>	∅ 21,5 cm	x 6

P.U.HT

**19,00 €**  
**11,00 €**  
**9,00 €**

Assiette plate

<b>1005777</b>	∅ 31,5 cm	x 3
<b>1005776</b>	∅ 27,5 cm	x 6
<b>1005779</b>	∅ 21,5 cm	x 6

P.U.HT

**19,00 €**  
**11,00 €**  
**9,00 €**



Assiette à pâtes

<b>1005771P</b>	∅ 28 cm	x 6
-----------------	---------	-----

P.U.HT

**18,00 €**

Assiette à pâtes

<b>1005781</b>	∅ 28 cm	x 6
----------------	---------	-----

P.U.HT

**18,00 €**



Assiette creuse

<b>1005782</b>	∅ 22,2 cm	x 6
----------------	-----------	-----

P.U.HT

**11,00 €**

Assiette creuse

<b>1005780</b>	∅ 22,2 cm	x 6
----------------	-----------	-----

P.U.HT

**11,00 €**

## ONDE

En porcelaine blanche.



Assiette plate

<b>1002374</b>	∅ 31,5 cm	x 3
<b>1002375P</b>	∅ 27,5 cm	x 6
<b>1002378</b>	∅ 21,5 cm	x 6

P.U.HT

**19,25 €**  
**8,90 €**  
**7,60 €**



Assiette à pâtes

<b>1002377</b>	∅ 28 cm	x 6
----------------	---------	-----

P.U.HT

**16,75 €**



Assiette à pain

<b>1002379</b>	∅ 15,5 cm	x 6
----------------	-----------	-----

P.U.HT

**5,50 €**





STONE

## Stone

En grès coloré.

Ivoire



Assiette coupe plate

<b>1007452</b>	Ø 29 cm	x 6	<b>P.U. HT</b>	<b>12,00 €</b>
<b>1007449</b>	Ø 27,5 cm	x 6		<b>8,00 €</b>
<b>1007450</b>	Ø 21 cm	x 6		<b>7,00 €</b>

Gris



Assiette coupe plate

<b>1007456P</b>	Ø 29 cm	x 6	<b>P.U. HT</b>	<b>13,00 €</b>
<b>1007453P</b>	Ø 27,5 cm	x 6		<b>9,60 €</b>
<b>1007454</b>	Ø 21 cm	x 6		<b>8,00 €</b>

Rouge

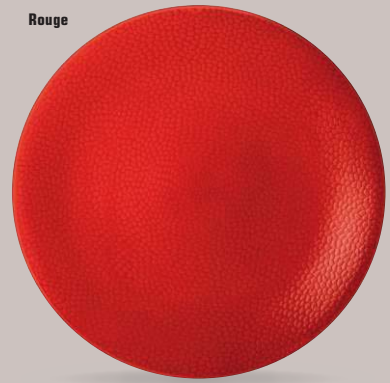

Assiette coupe plate

<b>1007460</b>	Ø 29 cm	x 6	<b>P.U. HT</b>	<b>13,00 €</b>
<b>1007457</b>	Ø 27,5 cm	x 6		<b>9,60 €</b>
<b>1007458</b>	Ø 21 cm	x 6		<b>8,00 €</b>



Assiette coupe creuse

<b>1007461P</b>	Ø 25 cm	x 6	<b>P.U. HT</b>	<b>12,00 €</b>
-----------------	---------	-----	----------------	----------------



Assiette coupe creuse

<b>1007462P</b>	Ø 25 cm	x 6	<b>P.U. HT</b>	<b>13,00 €</b>
-----------------	---------	-----	----------------	----------------



Assiette coupe creuse

<b>1007463P</b>	Ø 25 cm	x 6	<b>P.U. HT</b>	<b>13,00 €</b>
-----------------	---------	-----	----------------	----------------



Bol à salade

<b>1007451</b>	Ø 19 cm - 60 cl	x 6	<b>P.U. HT</b>	<b>7,00 €</b>
----------------	-----------------	-----	----------------	---------------



Bol à salade

<b>1007455P</b>	Ø 19 cm - 60 cl	x 6	<b>P.U. HT</b>	<b>8,00 €</b>
-----------------	-----------------	-----	----------------	---------------



Bol à salade

<b>1007459P</b>	Ø 19 cm - 60 cl	x 6	<b>P.U. HT</b>	<b>8,00 €</b>
-----------------	-----------------	-----	----------------	---------------

STONE



ART DE LA TABLE

# SAVOR



## Savor

En porcelaine Maxima garantie 5 ans contre les ébréchures pour les pièces rondes.



Assiette gourmet Ø 31 cm			P.U.HT
1008041	Noir	x 12	25,25 €
1008039	Caramel	x 12	25,25 €
1008040	Taupe	x 12	25,25 €
57470	Blanc	x 12	21,00 €
64412	Blanc mat satiné	x 12	25,25 €



Cloche Ø 17,2 x H. 9,4 cm			P.U.HT
57471	Blanc	x 12	12,00 €
1008047	Noir	x 12	14,00 €



# PURITY

## Purity

En porcelaine Maxima.



Assiette carrée 28 x 28 cm			P.U.HT
57478	Blanc	x 12	29,25 €

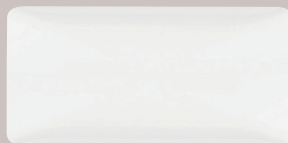

Assiette rectangulaire 27,5 x 13 cm			P.U.HT
1008049	Noir	x 24	22,75 €
57481	Blanc	x 24	21,00 €



# SUBLIME

## Sublime

En porcelaine Maxima garantie 5 ans contre les ébréchures pour les pièces rondes.



Assiette coupe Ø 31 cm			P.U.HT
57475P		x 12	21,00 €

La porcelaine Maxima offre une grande résistance aux chocs mécaniques, thermiques et aux rayures.







# FRAGMENT

## Fragment

En porcelaine Maxima. Chaque décor s'adapte à la taille de l'assiette.



Assiette plate			P.U. HT
<b>1011605</b>	Ø 28,5 cm	x 24	<b>12,40 €</b>
<b>1011604</b>	Ø 25,5 cm	x 24	<b>10,60 €</b>
<b>1011603</b>	Ø 21,5 cm	x 24	<b>7,30 €</b>



Assiette creuse			P.U. HT
<b>1011606</b>	Ø 24 cm	x 24	<b>10,60 €</b>



Coupelle			P.U. HT
<b>1011607</b>	Ø 13 cm	x 24	<b>5,70 €</b>

# WATER PEARL



## Water Pearl

En porcelaine Maxima.

Chaque assiette a un design unique et différent.



Assiette plate			P.U. HT
<b>1008358</b>	Ø 32 cm	x 6	<b>26,25 €</b>
<b>1008359P</b>	Ø 28,5 cm	x 6	<b>16,00 €</b>
<b>1008360</b>	Ø 25,5 cm	x 6	<b>15,25 €</b>
<b>1008361</b>	Ø 21,5 cm	x 6	<b>14,00 €</b>
<b>1008357</b>	Ø 17,5 cm	x 24	<b>8,00 €</b>



Assiette creuse			P.U. HT
<b>1008362</b>	Ø 24,5 cm	x 24	<b>15,25 €</b>





— CRÉATEUR D'EXPÉRIENCES —



## Présentations inédites

Voyage épicurien au pays des épices. Les assiettes en porcelaine de la collection Holi affichent l'élégance de la sobriété.

Leur décor puise son inspiration dans les épices, comme si un souffle les y avait éparpillées.

Elles offrent une surface utile ample et jouent avec les espaces unis et colorés pour mettre en valeur vos compositions culinaires.

Ces assiettes habillent vos tables de leur style contemporain raffiné.

Collection imaginée par le designer Jean-Philippe Nuel.



# HOLI

## Holi

En porcelaine Maxima. A coordonner avec Eternity.



# ETERNITY

## Eternity

En porcelaine Maxima. Une forme développée par Jean Philippe NUEL.



## Concrète

En porcelaine Maxima.



Assiette plate  
**1011521** Ø 28,5 cm x 24 **P.U. HT 12,40 €**



Assiette plate  
**1011522** Ø 25,5 cm x 24 **P.U. HT 11,00 €**  
**1011523** Ø 21,5 cm x 24 **P.U. HT 7,30 €**



Assiette ultra plate  
**1011509P** Ø 28,5 cm x 6 **P.U. HT 9,20 €**  
**1011510P** Ø 25,5 cm x 6 **P.U. HT 8,10 €**  
**1011511P** Ø 21,5 cm x 6 **P.U. HT 5,40 €**  
**1011512P** Ø 16 cm x 6 **P.U. HT 3,50 €**



Assiette creuse  
**1011513P** Ø 24 cm x 6 **P.U. HT 7,90 €**



Assiette plate  
**1011518** Ø 28,5 cm x 24 **P.U. HT 12,40 €**



Assiette carrée  
**1011519** L. 28 x l. 28 cm x 12 **P.U. HT 18,25 €**



Assiette rectangle  
**1011520** L. 27,5 x l. 13 cm x 24 **P.U. HT 15,25 €**





# SATINIQUE

## Satinique

En porcelaine Maxima. Porcelaine garantie 5 ans contre les ébréchures pour les pièces rondes. Consultez les conditions de garantie auprès de votre magasin.



### Assiette plate

	∅	x	P.U. HT
57450	31 cm	x 12	26,25 €
57445P	28,5 cm	x 6	15,75 €
57446P	25 cm	x 12	15,50 €
57447P	21 cm	x 12	14,50 €
57448P	17 cm	x 12	7,30 €



### Tasse à café

57452P 10 cl x 12 P.U. HT 10,40 €

### Tasse à thé

57454P 26 cl x 6 P.U. HT 11,80 €

### Sous-tasse à café

57453P ∅ 12,5 cm x 12 P.U. HT 5,40 €

### Sous-tasse à thé

57457P ∅ 16,5 cm x 6 P.U. HT 6,10 €



Bol 57467 ∅ 13 cm - 45 cl x 24 P.U. HT 8,30 €



### Assiette creuse

	∅	x	P.U. HT
57466	31 cm	x 12	37,75 €
57449	24 cm	x 24	15,50 €



### Tasse à café empilable

60129 10 cl x 24 P.U. HT 11,10 €

### Tasse à thé empilable

60130 18 cl x 24 P.U. HT 11,80 €

### Tasse à déjeuner empilable

57455 27 cl x 24 P.U. HT 14,40 €

### Sous-tasse à café

57453P ∅ 12,5 cm x 12 P.U. HT 5,40 €

### Sous-tasse à thé

57457P ∅ 16,5 cm x 6 P.U. HT 6,10 €



Coupelle 57460 ∅ 12 cm - 23 cl x 24 P.U. HT 10,30 €





# BLACK & GREY

## Satinique Black & Grey

En porcelaine Maxima.

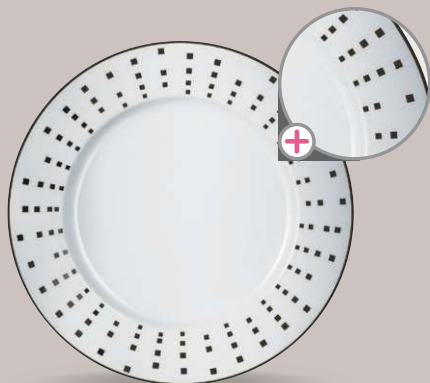

Assiette plate noire

<b>1008029P</b>	∅ 28,5 cm	x 6	<b>P.U.HT</b>	<b>16,00 €</b>
<b>1008030</b>	∅ 21,5 cm	x 6		<b>15,00 €</b>

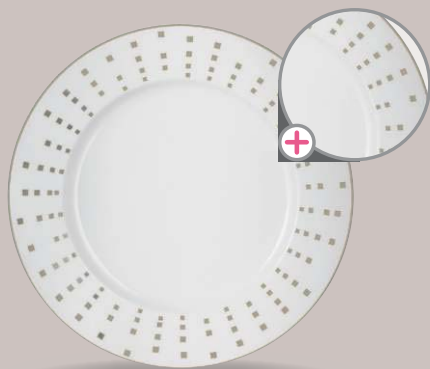

Assiette plate grise

<b>1008032</b>	∅ 28,5 cm	x 6	<b>P.U.HT</b>	<b>16,00 €</b>
<b>1008033</b>	∅ 21,5 cm	x 6		<b>15,00 €</b>



# BLACK & GREY

## Ginseng Black & Grey

En porcelaine Maxima.



Assiette plate noire

<b>1008023</b>	∅ 28,5 cm	x 24	<b>P.U.HT</b>	<b>16,00 €</b>
<b>1008024</b>	∅ 21,5 cm	x 24		<b>15,00 €</b>

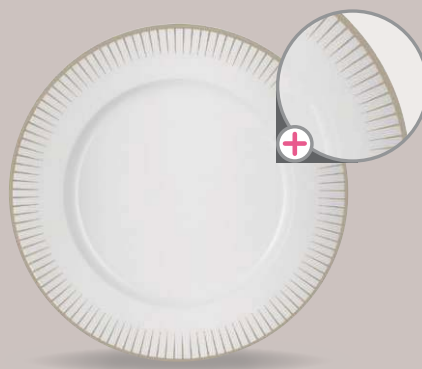

Assiette plate grise

<b>1008026</b>	∅ 28,5 cm	x 24	<b>P.U.HT</b>	<b>16,00 €</b>
<b>1008027</b>	∅ 21,5 cm	x 24		<b>15,00 €</b>

SATINIQUE BLACK/GINSENG BLACK & GREY



ART DE LA TABLE

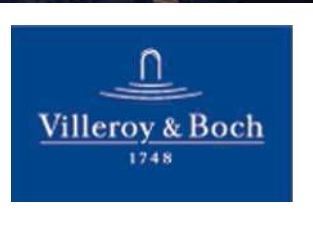

## SOUP PASSION

Des formes magnifiques pour une présentation originale des soupes. Avec les bols de Soup Passion déguster une soupe devient une expérience unique pour les cinq sens. Soup Passion est une source d'inspiration pour toutes sortes de créations passionnantes !



## Blossom

En porcelaine Bone China crème.



Assiette plate

<b>1010309</b>	Ø 32 cm	x 1	<b>28,00 €</b>		
<b>1010308</b>	Ø 27 cm	x 6	<b>18,00 €</b>		
<b>1010307</b>	Ø 21 cm	x 6	<b>10,70 €</b>		
<b>1010306</b>	Ø 17 cm	x 6	<b>8,30 €</b>		



Assiette creuse

<b>1010305</b>	Ø 23 cm	x 6	<b>14,90 €</b>



Coupelle

<b>1010310</b>	Ø 16 cm - 40 cl	x 6	<b>10,50 €</b>



## Modern Grace

En porcelaine Bone China crème.



Assiette plate carrée

<b>71165</b>	L. 31 x l. 31 cm	x 1	<b>26,25 €</b>
<b>69095</b>	L. 27 x l. 27 cm	x 6	<b>20,50 €</b>
<b>69096</b>	L. 23 x l. 23 cm	x 6	<b>17,25 €</b>



Assiette creuse

<b>1005788</b>	L. 24 x l. 21 cm	x 6	<b>18,50 €</b>



Assiette de présentation

<b>71166</b>	L. 44 x l. 23 cm	x 1	<b>32,00 €</b>
<b>71167P</b>	L. 35 x l. 18 cm	x 1	<b>25,25 €</b>

Assiette plate rectangle

<b>1005798P</b>	L. 24 x l. 14 cm	x 6	<b>13,80 €</b>



# PASTA PASSION



# SOUP PASSION

**nouveau !**

## Pasta passion

En porcelaine crème.



Assiette à pâtes

**1010312** Ø 30,5 cm  
**1010313** Ø 27 cm



x 2  
x 2

**P.U.HT**  
**28,00 €**  
**12,70 €**



Assiette à spaghetti

**1010311** L. 30,7 x l. 26,3 x H. 5,7 cm



x 2

**P.U.HT**  
**14,70 €**

## Soup passion

En porcelaine crème.



Bol

**1013086** L. 27,5 x l. 17,3 x H. 6,8 cm  
**1013085** L. 23 x l. 13 x H. 5,2 cm



x 2  
x 2

**P.U.HT**  
**13,10 €**  
**8,80 €**



A

B

Bol

A **1013088** Ø 20,5 cm  
B **1013087** Ø 13 cm - avec couvercle



x 6  
x 6

**P.U.HT**  
**13,10 €**  
**10,00 €**



Bol bouillon

**1009488** Ø 14 cm - 50 cl



x 6

**P.U.HT**  
**11,40 €**



Plateau

**1009458** L. 33 x l. 16 cm



x 2

**P.U.HT**  
**13,10 €**



Coupelle

**1013089** Ø 13 cm - 7 cl



x 4

**P.U.HT**  
**3,30 €**







## Artesano

En porcelaine crème et bois d'acacia.



Assiette plate

**1007395** Ø 27 cm x 6 **P.U.HT 13,10 €**  
**1007399** Ø 22 cm x 6 **8,30 €**



Assiette creuse

**1005620** Ø 25 cm x 6 **P.U.HT 11,10 €**



Plaque antipasti

**1010341** L. 51 x l. 25 cm x 1 **P.U.HT 25,75 €**



Plat rond antipasti

**1010340** Ø 28 cm x 1 **P.U.HT 20,75 €**



Plateau

**1013092** L. 30 x l. 9,5 cm x 1 **P.U.HT 12,90 €**



Etagère seule bois et ardoise

**1010339** L. 41 x l. 25,5 x H. 49 cm x 1 **P.U.HT 61,50 €**



Plat coupe ovale

**1010336** L. 55 x l. 17 cm x 1 **P.U.HT 37,75 €**  
**1010337** L. 44 x l. 14 cm x 1 **19,50 €**  
**1010338** L. 28 x l. 8 cm x 1 **10,50 €**



Saladier empilable

**1007637** Ø 28 cm x 1 **P.U.HT 30,25 €**



Coupelle antipasti

**1007118** L. 24 x l. 13,5 cm x 6 **P.U.HT 18,00 €**  
**1007119** L. 17 x l. 9,5 cm x 6 **14,70 €**



Bol empilable

**1009497** 60 cl x 4 **P.U.HT 11,70 €**



Coupelle

**1013090** Ø 13 cm - 29 cl x 6 **P.U.HT 10,00 €**  
**1013091** Ø 8 cm - 9 cl x 6 **5,90 €**



Tasse à expresso

**1007116** 9 cl x 6 **P.U.HT 6,90 €**



Sous tasse à expresso

**1013095** Ø 13 cm x 6 **P.U.HT 5,30 €**



Tasse à thé

**1007115** 18 cl x 6 **P.U.HT 7,80 €**



Sous tasse à thé

**1013094** Ø 17 cm x 6 **P.U.HT 6,00 €**



Sous tasse à café/thé gourmand

**1007117** L. 29 x l. 16 cm x 6 **P.U.HT 9,50 €**



Mug

**1013093** 38 cl x 6 **P.U.HT 9,40 €**

# SEDONA

## Sedona

En porcelaine crème. Garantie 3 ans contre les ébréchures.

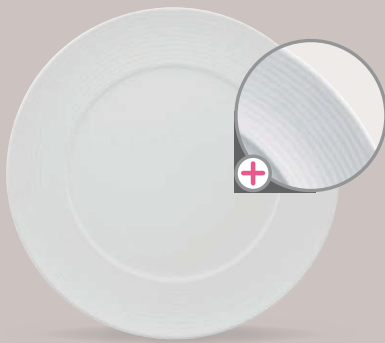

Assiette plate avec aile

<b>1005738</b>	Ø 32 cm	x 6	<b>P.U.HT</b>
<b>1005744</b>	Ø 25 cm	x 6	<b>25,00 €</b>
<b>62649</b>	Ø 18 cm	x 6	<b>13,30 €</b>
			<b>18,25 €</b>



Assiette coupe plate

<b>1005741</b>	Ø 32 cm	x 6	<b>P.U.HT</b>
<b>1005739</b>	Ø 29 cm	x 6	<b>25,00 €</b>
<b>1005743</b>	Ø 21 cm	x 6	<b>18,25 €</b>
			<b>9,80 €</b>



Tasse à expresso

<b>66398</b>	8 cl	x 12	<b>P.U.HT</b>
			<b>8,40 €</b>



Sous-tasse à expresso

<b>66399</b>	Ø 13 cm	x 12	<b>P.U.HT</b>
			<b>6,40 €</b>



Assiette plate

<b>1005740</b>	Ø 29 cm	x 6	<b>P.U.HT</b>
			<b>18,25 €</b>



Assiette coupe creuse

<b>1005742</b>	Ø 29 cm	x 6	<b>P.U.HT</b>
			<b>18,25 €</b>



Tasse à déjeuner

<b>66396</b>	22 cl	x 12	<b>P.U.HT</b>
			<b>10,00 €</b>



Sous-tasse à déjeuner

<b>66397</b>	Ø 16 cm	x 12	<b>P.U.HT</b>
			<b>7,00 €</b>



Assiette Gourmet

<b>62653</b>	Ø 29 cm - Ø bassin 14 cm	x 6	<b>P.U.HT</b>
			<b>18,25 €</b>



Coupelle

<b>1005745</b>	Ø 14 cm - 10 cl	x 6	<b>P.U.HT</b>
			<b>6,60 €</b>



Sucrier avec couvercle

<b>66400</b>	16 cl	x 6	<b>P.U.HT</b>
			<b>16,25 €</b>



Théière

<b>66395</b>	40 cl	x 1	<b>P.U.HT</b>
			<b>37,50 €</b>





**New Wave**

En porcelaine crème.



Assiette plate rectangle  
**50043** L. 33 x l. 24 cm x 6 **P.U.HT 21,25 €**



Assiette plate carrée  
**53755** L. 27 x l. 27 cm x 6 **P.U.HT 21,25 €**



Tasse à espresso  
**1005623** 8 cl x 6 **P.U.HT 11,50 €**



Tasse à cappuccino  
**1005621** 25 cl x 6 **P.U.HT 13,90 €**



Assiette à dessert  
**50042** L. 24 x l. 22 cm x 4 **P.U.HT 14,50 €**



Assiette plate antipasti  
**71168** L. 42 x l. 15 cm x 1 **P.U.HT 17,75 €**



Sous-tasse à espresso/ cappuccino  
**1005625** L. 17 x l. 13 cm x 6 **P.U.HT 9,10 €**



Tasse à thé  
**1005622** 20 cl x 6 **P.U.HT 11,70 €**



Coupelle  
**1000040** 30 cl x 6 **P.U.HT 11,20 €**



Sous-tasse à thé/ déjeuner  
**1005624** L. 20 x l. 14 cm x 6 **P.U.HT 10,60 €**



## **Metalfusion**

incarne le chic ultime grâce à une technique avancée pour appliquer une couleur à l'allure précieuse, or, argent ou bronze.

Faites une entrée fracassante avec une présentation spectaculaire, suivie d'une dégustation pleine de sensations grâce à ses textures et teintes d'exception.

# MÉTALFUSION

nouveau !

## Métalfusion

En porcelaine extra résistante.



Assiette plate moulurée

Ø 33 cm

			P.U.HT
1012716	Bronze	x 6	28,25 €
1012717	Gold	x 6	28,25 €
1012718	Silver	x 6	28,25 €



Assiette plate à aile

Ø 32 cm

			P.U.HT
1012752	Bronze	x 6	26,75 €
1012753	Gold	x 6	26,75 €
1012754	Silver	x 6	26,75 €

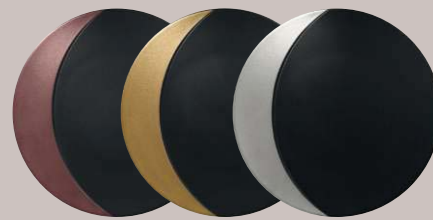

Assiette plate

Ø 31 cm

			P.U.HT
1012743	Bronze	x 6	27,00 €
1012744	Gold	x 6	27,00 €
1012745	Silver	x 6	27,00 €

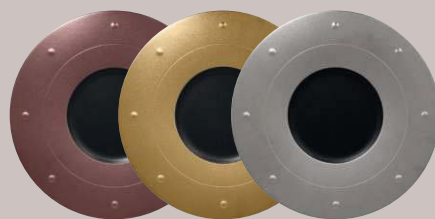

Assiette gourmet plate

Ø 31 cm

			P.U.HT
1012734	Bronze	x 6	27,50 €
1012735	Gold	x 6	27,50 €
1012736	Silver	x 6	27,50 €



Assiette gourmet plate

Ø 29 cm

			P.U.HT
1012731	Bronze	x 12	22,50 €
1012732	Gold	x 12	22,50 €
1012733	Silver	x 12	22,50 €



Assiette creuse

Ø 27 cm

			P.U.HT
1012740	Bronze	x 12	23,75 €
1012741	Gold	x 12	23,75 €
1012742	Silver	x 12	23,75 €

Ø 24 cm

			P.U.HT
1012737	Bronze	x 12	18,75 €
1012738	Gold	x 12	18,75 €
1012739	Silver	x 12	18,75 €



Assiette gourmet creuse

Ø 29 cm

			P.U.HT
1012728	Bronze	x 6	24,75 €
1012729	Gold	x 6	24,75 €
1012730	Silver	x 6	24,75 €

Ø 26 cm

			P.U.HT
1012725	Bronze	x 6	21,00 €
1012726	Gold	x 6	21,00 €
1012727	Silver	x 6	21,00 €



Cloche

Ø 15,5 x H. 11 cm

			P.U.HT
1012722	Bronze	x 6	15,50 €
1012723	Gold	x 6	15,50 €
1012724	Silver	x 6	15,50 €

Ø 13,6 x H. 9,5 cm

			P.U.HT
1012719	Bronze	x 6	14,70 €
1012720	Gold	x 6	14,70 €
1012721	Silver	x 6	14,70 €



Assiette carrée

L. 25 x l. 25 cm

			P.U.HT
1012749	Bronze	x 12	28,25 €
1012750	Gold	x 12	28,25 €
1012751	Silver	x 12	28,25 €



Assiette rectangle

L. 25 x l. 20 cm

			P.U.HT
1012746	Bronze	x 12	24,25 €
1012747	Gold	x 12	24,25 €
1012748	Silver	x 12	24,25 €





NÉOFUSION

## Néofusion

En porcelaine extra résistante.

**nouveau !**



Assiette coupe plate

Lavender			P.U.HT
1013080	Ø 31 cm	x 6	14,20 €
1013078	Ø 27 cm	x 12	10,10 €
1013076	Ø 24 cm	x 12	7,10 €
1013074	Ø 21 cm	x 12	6,10 €
1013072	Ø 15 cm	x 24	4,60 €

Purple			P.U.HT
1013081	Ø 31 cm	x 6	14,20 €
1013079	Ø 27 cm	x 12	10,10 €
1013077	Ø 24 cm	x 12	7,10 €
1013075	Ø 21 cm	x 12	6,10 €
1013073	Ø 15 cm	x 24	4,60 €



Assiette coupe creuse Ø 30 cm

			P.U.HT
✓ 1007237P	Noir Volcano	x 6	18,00 €
1007238P	Rouge Magma	x 6	18,00 €
1007239P	Rouge Ember	x 6	18,00 €
1007240P	Gris Stone	x 6	18,00 €



Noir Volcano

			P.U.HT
✓ 1007162P	Ø 31 cm	x 6	14,20 €
✓ 1007168P	Ø 27 cm	x 12	10,10 €
✓ 1007174P	Ø 24 cm	x 12	7,10 €
✓ 1007180P	Ø 21 cm	x 12	6,10 €
✓ 1007186P	Ø 18 cm	x 24	5,00 €
1007192P	Ø 15 cm	x 24	4,60 €

Gris Stone

			P.U.HT
✓ 1007165P	Ø 31 cm	x 6	14,20 €
✓ 1007171P	Ø 27 cm	x 12	10,10 €
✓ 1007177P	Ø 24 cm	x 12	7,10 €
✓ 1007183P	Ø 21 cm	x 12	6,10 €
1007195P	Ø 15 cm	x 24	4,60 €



Assiette coupe creuse Ø 26 cm

			P.U.HT
1013084P	Noir volcano	x 12	16,25 €
1013063	Rouge Magma	x 12	16,25 €
1013062	Rouge Ember	x 12	16,25 €
1013064	Stone	x 12	16,25 €
1013066	Lavender	x 12	16,25 €
1013067	Purple	x 12	16,25 €



Rouge Magma

			P.U.HT
✓ 1007163P	Ø 31 cm	x 6	14,20 €
✓ 1007169P	Ø 27 cm	x 12	10,10 €
1007175P	Ø 24 cm	x 12	7,10 €
1007181P	Ø 21 cm	x 12	6,10 €
1007193P	Ø 15 cm	x 24	4,60 €

Rouge Ember

			P.U.HT
1007164P	Ø 31 cm	x 6	14,20 €
1007170P	Ø 27 cm	x 12	10,10 €
1007176P	Ø 24 cm	x 12	7,10 €
1007182	Ø 21 cm	x 12	6,10 €
1007194P	Ø 15 cm	x 24	4,60 €

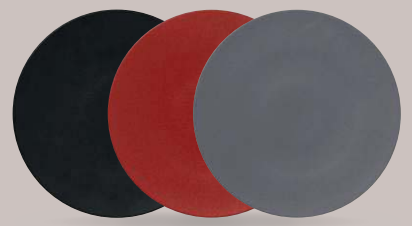

Assiette extra plate Ø 29 cm

			P.U.HT
1007155P	Noir Volcano	x 6	23,50 €
1007156	Rouge Magma	x 6	23,50 €
1007157	Gris Stone	x 6	23,50 €





Assiette plate Ø 30 cm, bassin Ø 8,8 cm

✓ 1007198P Noir Volcano x 12 P.U.HT 18,50 €



Assiette extra creuse Ø 26 cm, bassin Ø 15,2 cm

✓ 1007243P Noir Volcano x 6 P.U.HT 17,25 €  
 ✓ 1007244P Rouge Magma x 6 P.U.HT 17,25 €  
 ✓ 1007245P Rouge Ember x 6 P.U.HT 17,25 €  
 ✓ 1007246P Gris Stone x 6 P.U.HT 17,25 €

Assiette extra creuse Ø 23 cm, bassin Ø 13,8 cm

✓ 1007248P Noir Volcano x 6 P.U.HT 14,20 €  
 ✓ 1007249P Rouge Magma x 6 P.U.HT 14,20 €  
 ✓ 1007250 Rouge Ember x 6 P.U.HT 14,20 €  
 ✓ 1007251P Gris Stone x 6 P.U.HT 14,20 €  
 ✓ 1013068 Lavender x 6 P.U.HT 14,20 €  
 ✓ 1013069 Purple x 6 P.U.HT 14,20 €



Assiette extra creuse Ø 29 cm, bassin Ø 14,9 cm

✓ 1007253P Noir Volcano x 6 P.U.HT 26,50 €



Assiette rectangulaire L. 38 x l. 21 cm

✓ 1007221P Noir Volcano x 6 P.U.HT 25,50 €

Assiette rectangulaire L. 33 x l. 23 cm

✓ 1007226P Noir Volcano x 6 P.U.HT 18,50 €  
 ✓ 1007227P Rouge Magma x 6 P.U.HT 18,50 €  
 ✓ 1007228 Rouge Ember x 6 P.U.HT 18,50 €  
 ✓ 1007229P Gris Stone x 6 P.U.HT 18,50 €



Assiette carrée L. 30 x l. 30 cm

✓ 1007232P Noir Volcano x 6 P.U.HT 18,25 €

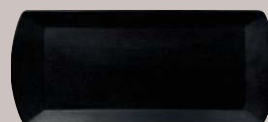

Assiette sandwich L. 35 x l. 15 cm

✓ 1007211P Noir Volcano x 12 P.U.HT 25,50 €



Plat ovale L. 36 x l. 27 cm

✓ 1007216P Noir Volcano x 6 P.U.HT 15,25 €  
 ✓ 1007217P Rouge Magma x 6 P.U.HT 15,25 €  
 ✓ 1007218P Gris Stone x 6 P.U.HT 15,25 €  
 ✓ 1013070 Lavender x 6 P.U.HT 15,25 €  
 ✓ 1013071 Purple x 6 P.U.HT 15,25 €



Gobelet basil Ø 6 x H. 7 cm - 9 cl

✓ 1007294P Noir Volcano x 12 P.U.HT 5,00 €



Cube L. 5 x l. 5 x H. 5,5 cm - 9 cl

✓ 1007341P Noir Volcano x 12 P.U.HT 6,10 €

Cube L. 5 x l. 5 x H. 4,5 cm - 6 cl

✓ 1007347P Noir Volcano x 12 P.U.HT 5,70 €

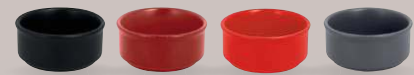

Ramequin Ø 8 x H. 3,5 cm - 10 cl

✓ 1007298P Noir Volcano x 12 P.U.HT 4,00 €  
 ✓ 1007299P Rouge Magma x 12 P.U.HT 4,00 €  
 ✓ 1007300 Rouge Ember x 12 P.U.HT 4,00 €  
 ✓ 1007301 Gris Stone x 12 P.U.HT 4,00 €

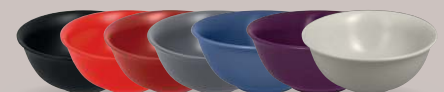

Bol Ø 16 x H. 6,5 cm - 58 cl

✓ 1007358P Noir Volcano x 12 P.U.HT 6,10 €  
 ✓ 1007357P Rouge Magma x 12 P.U.HT 6,10 €  
 ✓ 1007356P Rouge Ember x 12 P.U.HT 6,10 €  
 ✓ 1007355P Gris Stone x 12 P.U.HT 6,10 €  
 ✓ 1013082 Lavender x 12 P.U.HT 6,10 €  
 ✓ 1013083 Purple x 12 P.U.HT 6,10 €  
 ✓ 1007354 Blanc Sand x 12 P.U.HT 6,10 €

# VINTAGE

nouveau !

## Vintage

En porcelaine.

Effet craquelé 



### Assiette coupe plate

Ø 31 cm

			P.U.HT
1009441	Rose	x 6	15,75 €
1009439	Bleu	x 6	15,75 €
1009442	Vert	x 6	15,75 €
1009438	Blanc	x 6	15,75 €

Ø 24 cm

			P.U.HT
1009459	Rose	x 12	7,10 €
1009457	Bleu	x 12	7,10 €
1009460	Vert	x 12	7,10 €
1009456P	Blanc	x 12	7,10 €

Ø 15 cm

			P.U.HT
1009477	Rose	x 24	5,10 €
1009475	Bleu	x 24	5,10 €
1009478	Vert	x 24	5,10 €
1009474	Blanc	x 24	5,10 €

Ø 27 cm

			P.U.HT
1009453	Rose	x 12	10,20 €
1009451	Bleu	x 12	10,20 €
1009454	Vert	x 12	10,20 €
1009450P	Blanc	x 12	10,20 €

Ø 21 cm

			P.U.HT
1009465	Rose	x 12	6,20 €
1009463	Bleu	x 12	6,20 €
1009466	Vert	x 12	6,20 €
1009462	Blanc	x 12	6,20 €

P.U.HT

x 12	6,20 €
x 12	6,20 €
x 12	6,20 €
x 12	6,20 €



### Assiette coupe creuse

Ø 26 cm

			P.U.HT
1009489	Rose	x 12	17,00 €
1009487	Bleu	x 12	17,00 €
1009490	Vert	x 12	17,00 €
1009486P	Blanc	x 12	17,00 €

Ø 23 cm

			P.U.HT
1009495	Rose	x 12	8,10 €
1009493	Bleu	x 12	8,10 €
1009496	Vert	x 12	8,10 €
1009492	Blanc	x 12	8,10 €

P.U.HT

x 12	8,10 €
x 12	8,10 €
x 12	8,10 €
x 12	8,10 €



Plat ovale Ø 32 cm

			P.U.HT
1009561	Rose	x 6	16,75 €
1009559	Bleu	x 6	16,75 €
1009562	Vert	x 6	16,75 €
1009558	Blanc	x 6	16,75 €



Bol Ø 16 cm - 58 cl

			P.U.HT
1009507	Rose	x 12	8,90 €
1009505	Bleu	x 12	8,90 €
1009508	Vert	x 12	8,90 €
1009504	Blanc	x 12	8,90 €





# MAZZA

## Mazza

En porcelaine crème extra résistante.



Assiette plate carrée

Code	Dimensions	Quantité	P.U. HT
64018P	L. 32 x l. 29 cm	x 6	22,50 €
64017P	L. 26 x l. 23 cm	x 6	15,25 €
64016	L. 20 x l. 18 cm	x 6	8,70 €



Plat baguette

Code	Dimensions	Quantité	P.U. HT
64023P	L. 26 x l. 10 cm	x 6	10,50 €



Assiette cocktail

Code	Dimensions	Quantité	P.U. HT
64010P	L. 26 x l. 7,5 cm	x 6	9,80 €



Assiette plate rectangulaire

Code	Dimensions	Quantité	P.U. HT
64021P	L. 32 x l. 21 cm	x 6	19,75 €
64020P	L. 26 x l. 17 cm	x 6	11,00 €
64019	L. 20 x l. 13 cm	x 6	7,80 €



Plat élipse

Code	Dimensions	Quantité	P.U. HT
64027	L. 32 x l. 21 cm	x 6	24,75 €
64026	L. 26 x l. 17 cm	x 6	11,50 €
64025	L. 20 x l. 13 cm	x 6	8,70 €



Coupelle

Code	Dimensions	Quantité	P.U. HT
64031P	L. 11 x l. 5,5 cm	x 12	5,00 €
64032	L. 8 x l. 7,5 cm	x 6	4,60 €



nouveau !

## Woodart

En porcelaine.



Timber



Oak



Beech



Moss

## Assiette coupe

Ø 27 cm		📦	P.U.HT	Ø 24 cm		📦	P.U.HT	Ø 21 cm		📦	P.U.HT	Ø 15 cm		📦	P.U.HT
1012786	Timber	x 12	11,20 €	1012782	Timber	x 12	7,70 €	1012778	Timber	x 12	7,10 €	1012774	Timber	x 24	5,70 €
1012785	Oak	x 12	11,20 €	1012781	Oak	x 12	7,70 €	1012777	Oak	x 12	7,10 €	1012773	Oak	x 24	5,70 €
1012783	Beech	x 12	11,20 €	1012779	Beech	x 12	7,70 €	1012775	Beech	x 12	7,10 €	1012771	Beech	x 24	5,70 €
1012784	Moss	x 12	11,20 €	1012780	Moss	x 12	7,70 €	1012776	Moss	x 12	7,10 €	1012772	Moss	x 24	5,70 €



## Assiette coupe creuse

Ø 26 cm		📦	P.U.HT	Ø 23 cm		📦	P.U.HT
1012758	Timber	x 12	20,50 €	1012770	Timber	x 12	8,80 €
1012757	Oak	x 12	20,50 €	1012769	Oak	x 12	8,80 €
1012755	Beech	x 12	20,50 €	1012767	Beech	x 12	8,80 €
1012756	Moss	x 12	20,50 €	1012768	Moss	x 12	8,80 €

## Bol Ø 16 cm - 58 cl

		📦	P.U.HT
1012794	Timber	x 12	8,10 €
1012793	Oak	x 12	8,10 €
1012791	Beech	x 12	8,10 €
1012792	Moss	x 12	8,10 €





# KARBON

KARBON

nouveau !

## Karbon

En porcelaine.



Assiette coupe plate

			P.U. HT
<b>1013135</b>	∅ 31 cm	x 6	<b>15,00 €</b>
<b>1013133P</b>	∅ 27 cm	x 12	<b>10,00 €</b>
<b>1013132P</b>	∅ 24 cm	x 12	<b>6,60 €</b>
<b>1013131</b>	∅ 21 cm	x 12	<b>6,00 €</b>
<b>1013130</b>	∅ 15 cm	x 24	<b>5,00 €</b>



Assiette coupe creuse

			P.U. HT
<b>1013137</b>	∅ 26 cm	x 12	<b>16,00 €</b>
<b>1013136P</b>	∅ 23 cm	x 12	<b>7,00 €</b>



Bol

			P.U. HT
<b>1013139</b>	∅ 16 cm - 58 cl	x 12	<b>8,60 €</b>
<b>1013140P</b>	∅ 12 cm - 27 cl	x 12	<b>7,00 €</b>
<b>1013141</b>	∅ 10 cm - 16 cl	x 12	<b>6,00 €</b>



Plat ovale

			P.U. HT
<b>1013144</b>	L 36 x l 27 cm	x 6	<b>17,00 €</b>
<b>1013143</b>	L 32 x l 23 cm	x 6	<b>16,00 €</b>



Tasse à espresso

			P.U. HT
<b>1013145</b>	8 cl	x 12	<b>5,60 €</b>



Tasse à thé

			P.U. HT
<b>1013147</b>	20 cl	x 12	<b>8,00 €</b>



Sous tasse à espresso

			P.U. HT
<b>1013146</b>	∅ 13 cm	x 12	<b>5,00 €</b>



Sous tasse à thé

			P.U. HT
<b>1013148</b>	∅ 17 cm	x 12	<b>6,60 €</b>



ART DE LA TABLE

# ALLSPICE

## Allspice

En porcelaine crème extra-résistante.



**Assiette plate coupe Cilantro**  
**60619P** Ø 29 cm x 6 **P.U.HT**  
**14,60 €**



**Coupelle Chives**  
**64033P** Ø 14 cm - 32 cl x 12 **P.U.HT**  
**4,40 €**  
**64035P** Ø 11 cm - 20 cl x 12 **4,10 €**  
**64036P** Ø 8 cm - 11 cl x 12 **3,70 €**



**Assiette plate carrée Ginger**  
**61395P** L. 29 x l. 29 cm x 6 **P.U.HT**  
**13,20 €**  
**61396** L. 25 x l. 25 cm x 6 **12,40 €**  
**1005420** L. 21 x l. 21 cm x 12 **11,50 €**  
**61397P** L. 14 x l. 14 cm x 6 **9,60 €**



**Gobelet Basil**  
**61405P** 9 cl x 12 **P.U.HT**  
**4,00 €**



**Coupelle Curcuma**  
**60617** L. 15 x l. 15 cm x 6 **P.U.HT**  
**9,20 €**  
**60616P** L. 13 x l. 13 cm x 6 **8,50 €**



**Assiette rectangulaire Wasabi**  
**61398P** L. 28 x l. 14 cm x 6 **P.U.HT**  
**12,80 €**



**Plat rectangulaire Minimax**  
**70158** L. 35 x l. 15 cm x 12 **P.U.HT**  
**16,25 €**



**Plateaux gourmands, voir page 127**

Optimisation de la gestion et du service



**Plateau gourmand Wasabi**  
 Pouvant recevoir une multitude de contenants des gammes Rak, nous consulter.

**A - 2 empreintes Ø 5 et 7 cm**  
**68573P** L. 28 x l. 14 cm x 6 **P.U.HT**  
**16,50 €**

**B - 3 empreintes Ø 5, 6,7 et 9 cm.**  
**68572** L. 24 x l. 14 cm x 6 **P.U.HT**  
**17,75 €**

# AURÉA

## Auréa

En porcelaine crème extra-résistante.

**nouveau !**



**Plat rectangulaire**  
**1013057** L. 33 x l. 22 cm x 6 **P.U.HT**  
**20,50 €**  
**1013056** L. 33 x l. 11 cm x 12 **10,10 €**  
**1013055** L. 22 x l. 11 cm x 12 **6,70 €**



**Plat rectangulaire 3 empreintes**  
**1013059** L. 46 x l. 18 cm x 6 **P.U.HT**  
**23,50 €**



**Plat rectangulaire 2 empreintes**  
**1013058** L. 31 x l. 18 cm x 6 **P.U.HT**  
**15,25 €**



**Plat carré**  
**1013061** L. 18 x l. 18 cm - 1 empreinte x 12 **P.U.HT**  
**8,70 €**  
**1013060** L. 11 x l. 11 cm x 12 **3,00 €**



**Bol oval L. 20 x l. 10 cm - 20 cl**  
**1013052** Crème x 6 **P.U.HT**  
**5,60 €**  
**1013053** Noir x 6 **8,70 €**



**Bol vague Ø 12,3 cm - 42 cl**  
**1013050** Crème x 6 **P.U.HT**  
**6,70 €**  
**1013051** Noir x 6 **10,20 €**  
**Bol Ø 13,3 cm - 27 cl**  
**1013054** Crème x 6 **5,10 €**



## Fine dine

En porcelaine crème extra résistante.



Assiette plate Gourmet  **P.U.HT**  
**59256P** Ø 29 cm - Bassin Ø 11 cm x 12 **13,20 €**



Mug  **P.U.HT**  
**59276P** 30 cl x 12 **7,20 €**



Assiette plate  **P.U.HT**  
**68519P** Ø 33 cm x 6 **15,75 €**  
**59249P** Ø 31 cm x 6 **13,50 €**  
**59250P** Ø 29 cm x 12 **12,40 €**  
**59251P** Ø 27 cm x 12 **11,90 €**  
**59252P** Ø 22 cm x 12 **8,50 €**  
**59253P** Ø 16 cm x 24 **6,70 €**



Bol  **P.U.HT**  
**59264P** Ø 14 cm - 45 cl x 12 **9,60 €**  
**59263P** Ø 12 cm - 28 cl x 12 **6,60 €**  
**59262P** Ø 11 cm - 22 cl x 12 **5,70 €**



Saladier rond  **P.U.HT**  
**59265P** Ø 23 cm - 140 cl x 12 **13,60 €**



Sucrier avec couvercle  **P.U.HT**  
**59275P** 22 cl x 6 **13,00 €**



Assiette creuse  **P.U.HT**  
**59254P** Ø 31 cm x 6 **14,60 €**  
**59255P** Ø 23 cm x 12 **8,80 €**



Saladier ovale  **P.U.HT**  
**59268P** L. 27 x l. 19 cm x 6 **22,00 €**  
**59267P** L. 24 x l. 16 cm x 6 **18,00 €**  
**59266P** L. 16 x l. 11 cm x 6 **12,70 €**



Crémier  **P.U.HT**  
**59273P** 25 cl x 6 **10,40 €**  
**59274P** 15 cl x 6 **8,90 €**



Assiette creuse Gourmet  **P.U.HT**  
**68589P** Ø 29 cm Ø bassin 15 cm x 6 **16,50 €**  
**68588P** Ø 23 cm Ø bassin 11 cm x 6 **11,80 €**



Tasse à café  **P.U.HT**  
**59277P** 9 cl x 12 **5,60 €**



Cafetière avec couvercle  **P.U.HT**  
**59271P** 35 cl x 4 **19,75 €**



Assiette creuse Gourmet  **P.U.HT**  
**59257P** Ø 29 cm Ø bassin 14 cm x 12 **13,90 €**  
**59258P** Ø 26 cm Ø bassin 12,5 cm x 12 **12,00 €**

Tasse à thé  **P.U.HT**  
**59279P** 25 cl x 12 **8,10 €**

Tasse à thé  **P.U.HT**  
**59278P** 20 cl x 12 **7,60 €**

Tasse à déjeuner  **P.U.HT**  
**59280P** 30 cl x 12 **9,80 €**



Sous-tasse à café  **P.U.HT**  
**59281P** Ø 13 cm x 12 **4,00 €**

Sous-tasse à thé  **P.U.HT**  
**59282P** Ø 15 cm x 12 **4,70 €**

Sous-tasse à déjeuner  **P.U.HT**  
**59283P** Ø 17 cm x 12 **5,60 €**



Théière avec couvercle  **P.U.HT**  
**59272P** 40 cl x 4 **19,75 €**



Cloche pour assiette creuse Gourmet  **P.U.HT**  
**68522** Ø 15,5 cm pour assiette 29 cm x 6 **12,90 €**  
**68521** Ø 13,5 cm pour assiette 26 cm x 6 **11,80 €**





## GIRO

En porcelaine crème extra résistante.



Assiette plate

**1006476** Ø 30 cm x 6 **13,80 €**  
**1006477** Ø 27 cm x 12 **12,20 €**  
**1006479** Ø 21 cm x 24 **9,60 €**



Saladier

**1006494** L. 20 x l. 16 cm x 6 **P.U.HT 7,90 €**



Sous-tasse à espresso / déjeuner gourmand

**1006492P** L. 29 x l. 16 cm x 12 **P.U.HT 9,50 €**



Assiette ovale

**1007285** L. 33,7 x l. 27 cm x 12 **P.U.HT 16,00 €**  
**1006485** L. 34 x l. 22 cm x 6 **15,50 €**



Plat ovale

**1006495** L. 36 x l. 29 cm x 6 **P.U.HT 19,25 €**



Théière

**1006499** H. 8 cm - 40 cl x 6 **P.U.HT 12,50 €**



Tasse à espresso

**1006487P** 9 cl x 12 **P.U.HT 3,50 €**



Pot à sauce

**1006496P** Ø 6,7 x H. 11,5 cm - 14 cl x 12 **P.U.HT 3,90 €**



Assiette creuse

**1006483** L. 29 x l. 23 cm x 12 **P.U.HT 17,25 €**



Sous-tasse à espresso / thé

**1006489P** Espresso/thé Ø 14 cm x 12 **P.U.HT 2,70 €**



Pichet

**1006502** Ø 7,5 x H. 13,5 cm - 25 cl x 12 **P.U.HT 4,90 €**



# Gourmet

En porcelaine crème extra résistante. Garantie 5 ans contre les ébréchures sur certaines pièces : voir conditions en magasin.



Assiette plate

			P.U.HT
64546P	Ø 31 cm	x 6	9,30 €
64547P	Ø 29 cm	x 12	7,40 €
64548P	Ø 27 cm	x 12	6,30 €
64549P	Ø 24 cm	x 12	4,40 €
64550P	Ø 21 cm	x 24	4,40 €
64551	Ø 19 cm	x 24	3,70 €
64553P	Ø 15 cm	x 24	3,20 €



Assiette plate carrée

			P.U.HT
64561P	L. 30 x l. 30 cm	x 6	10,60 €
64562P	L. 27 x l. 27 cm	x 12	9,50 €
64563P	L. 24 x l. 24 cm	x 12	8,40 €



Assiette creuse

			P.U.HT
64555P	Ø 30 cm	x 6	8,70 €
64557P	Ø 26 cm	x 12	7,40 €
64559	Ø 24 cm	x 12	5,50 €



Saladier carré

			P.U.HT
64567P	L. 21 x l. 21 cm	x 6	9,00 €
64568P	L. 18 x l. 18 cm	x 12	7,20 €
64569P	L. 16 x l. 16 cm	x 12	5,70 €
64570P	L. 14 x l. 14 cm	x 12	4,60 €
64571P	L. 12 x l. 12 cm	x 12	3,80 €



Assiette extra creuse

			P.U.HT
70155P	Ø 26 cm	x 6	11,40 €
70154P	Ø 23 cm	x 6	9,70 €



Coquetier

			P.U.HT
64585P	Ø 4 cm x H. 7 cm	x 6	3,40 €



Tasse à café

			P.U.HT
64576P	9 cl	x 12	3,50 €

Tasse à thé

			P.U.HT
64577P	20 cl	x 12	4,20 €

Tasse à déjeuner

			P.U.HT
64578	23 cl	x 12	4,70 €

Tasse à thé/déjeuner

			P.U.HT
64579P	28 cl	x 12	5,30 €

Sous-tasse

			P.U.HT
64580P	Café - Ø 13 cm	x 12	2,40 €
64581P	Thé - Ø 15 cm	x 12	3,30 €
64586P	Déjeuner - Ø 17 cm	x 12	3,40 €



Assiette rectangulaire

			P.U.HT
64566P	L. 38 x l. 21 cm	x 6	15,75 €
68520P	L. 33 x l. 23 cm	x 6	11,40 €
64564P	L. 29 x l. 12 cm	x 12	11,00 €
1013126P	L. 21 x l. 8 cm	x 24	8,10 €



## GOURMET

Optimisation de la gestion et du service



Sous-tasse mixte

Compatible avec plusieurs contenants : tasses, bols, mugs des collections Rak, nous consulter.

			P.U.HT
1007288	Ø 17 cm	x 12	3,50 €



Sous-tasse universelle

Compatible avec plusieurs contenants : tasses, bols, mugs des collections Rak, nous consulter.

			P.U.HT
68523P	Ø 15 cm	x 12	3,10 €



Crémier

			P.U.HT
64574P	25 cl	x 12	5,20 €
64575P	15 cl	x 12	4,90 €



Théière avec couvercle

			P.U.HT
64573P	H. 14 cm - 40 cl	x 4	11,90 €

GOURMET



ART DE LA TABLE

# NANO

## Nano

En porcelaine crème extra résistante.



Assiette coupe plate		📦	P.U.HT
✓ 70159P	∅ 31 cm	x 6	8,10 €
✓ 66215P	∅ 27 cm	x 12	4,40 €
✓ 66214P	∅ 24 cm	x 12	3,20 €
✓ 70160P	∅ 21 cm	x 12	3,00 €
✓ 66213P	∅ 18 cm	x 24	2,60 €
✓ 70161P	∅ 15 cm	x 24	2,40 €



Bol		📦	P.U.HT
✓ 1000653P	∅ 20 cm - 90 cl	x 6	4,90 €



Assiette coupe creuse		📦	P.U.HT
✓ 64043P	∅ 30 cm	x 6	11,90 €
✓ 70162P	∅ 26 cm	x 12	7,90 €
✓ 1007693P	∅ 23 cm	x 12	3,40 €



Bol non empilable		📦	P.U.HT
✓ 1000652P	∅ 12 cm - 27 cl	x 12	3,60 €
✓ 1000651P	∅ 10 cm - 16 cl	x 12	3,00 €
✓ 1000650P	∅ 9 cm - 11 cl	x 12	2,60 €



Plat coupe ovale		📦	P.U.HT
✓ 66216P	L. 36 x l. 27 cm	x 6	8,60 €
✓ 70163P	L. 32 x l. 23 cm	x 6	8,00 €
✓ 70164P	L. 26 x l. 19 cm	x 12	6,10 €
✓ 70165P	L. 21 x l. 15 cm	x 12	4,30 €



Assiette à beurre		📦	P.U.HT
✓ 1002745P	∅ 7 cm	x 12	2,30 €





## Anna



En porcelaine crème extra résistante. Garantie 5 ans contre les ébréchures sur certaines pièces, voir conditions en magasin.

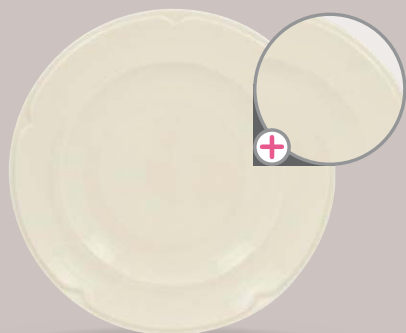

<b>Assiette</b>			<b>P.U. HT</b>
<b>1005047P</b>	Ø 27 cm	x 12	<b>6,70 €</b>
<b>1005048P</b>	Ø 24 cm	x 12	<b>4,90 €</b>
<b>1005049P</b>	Ø 20,8 cm	x 24	<b>4,40 €</b>
<b>1005423</b>	Ø 17 cm	x 24	<b>3,90 €</b>



<b>Tasse à thé</b>			<b>P.U. HT</b>
<b>1005058</b>	20 cl	x 12	<b>4,50 €</b>



<b>Tasse à déjeuner</b>			<b>P.U. HT</b>
<b>1005060</b>	28 cl	x 12	<b>6,40 €</b>



<b>Assiette creuse</b>			<b>P.U. HT</b>
<b>1005050</b>	Ø 24 cm	x 12	<b>6,10 €</b>



<b>Sous-tasse à espresso</b>			<b>P.U. HT</b>
<b>1005057</b>	Ø 13 cm	x 12	<b>2,70 €</b>
<b>Sous-tasse à thé/déjeuner</b>			<b>P.U. HT</b>
<b>1005059</b>	Ø 16 cm	x 12	<b>3,20 €</b>



<b>Tasse à espresso</b>			<b>P.U. HT</b>
<b>1005056</b>	8 cl	x 12	<b>3,20 €</b>



<b>Coupelle</b>			<b>P.U. HT</b>
<b>1005055P</b>	Ø 14 cm - 48 cl	x 12	<b>5,00 €</b>





# BANQUET

## Banquet

En porcelaine crème extra résistante.  
Garantie 5 ans contre les ébréchures : voir conditions en magasin.



### Assiette plate

Code	Dimensions	Quantité	P.U. HT
59195P	Ø 31 cm	x 6	7,90 €
59194P	Ø 30 cm	x 6	7,00 €
59193P	Ø 29 cm	x 12	6,20 €
59192P	E Ø 27 cm	x 12	4,80 €
59191P	Ø 25 cm	x 12	4,10 €
59190P	E Ø 24 cm	x 12	3,60 €
59189P	Ø 23 cm	x 12	3,50 €
59188P	Ø 21 cm	x 24	3,40 €
59187P	Ø 20 cm	x 24	3,20 €
59186P	E Ø 19 cm	x 24	2,90 €
59185P	Ø 17 cm	x 24	2,80 €
59184P	E Ø 15 cm	x 24	2,50 €
59183P	Ø 13 cm	x 24	2,40 €



### Assiette à steak

Code	Dimensions	Quantité	P.U. HT
59199P	L. 30 x l. 25,5 cm	x 6	6,10 €



### Saladier

Code	Dimensions	Quantité	P.U. HT
59213P	Ø 31 cm	x 1	17,25 €
59212P	E Ø 25 cm	x 1	9,80 €
59211P	Ø 20 cm	x 12	4,70 €
59210P	Ø 16 cm	x 12	3,80 €
63623P	Ø 14 cm	x 12	3,60 €
63622P	Ø 12 cm	x 12	3,40 €



### Assiette à pizza

Code	Dimensions	Quantité	P.U. HT
70157P	Ø 33 cm	x 6	6,80 €
59202P	Ø 30,5 cm	x 6	6,10 €



### Saladier empilable

Code	Dimensions	Quantité	P.U. HT
59209P	E Ø 21 cm	x 12	9,30 €
59208P	E Ø 18 cm	x 12	7,10 €
59207P	E Ø 16 cm	x 12	4,20 €
59206P	E Ø 12 cm	x 12	3,50 €



### Assiette creuse

Code	Dimensions	Quantité	P.U. HT
59196P	Ø 30 cm - bassin Ø 20 cm	x 6	7,50 €
59197P	Ø 26 cm - bassin Ø 17,5 cm	x 12	4,90 €
59198P	E Ø 23 cm - bassin Ø 15,5 cm	x 12	3,30 €



### Plat ovale

Code	Dimensions	Quantité	P.U. HT
59201P	L. 38 x l. 26 cm	x 6	10,20 €
59200P	L. 32 x l. 22 cm	x 6	8,60 €



### Saucière

Code	Dimensions	Quantité	P.U. HT
59233	15 cl	x 6	7,70 €



### Ramequin

Code	Dimensions	Quantité	P.U. HT
59240P	Ø 7 cm - 6 cl	x 12	2,50 €



### Condiment

Code	Dimensions	Quantité	P.U. HT
59229P	Salière	x 6	4,70 €
59230P	Poivrière	x 6	4,70 €



# BANQUET

## Banquet

En porcelaine crème extra résistante.



Coquetier  
**59231P** Ø 5,2 cm

**P.U.HT**  
x 6 **3,10 €**



Porte cure dent  
**59235P** Ø 5,5 x H. 6 cm - 7 cl

**P.U.HT**  
x 12 **2,60 €**



Porte sachet de sucre  
**59227P** L. 11 x l. 7 x H. 4 cm - 20 cl

**P.U.HT**  
x 6 **5,30 €**



Soliflore  
**59232** H. 12 cm

**P.U.HT**  
x 6 **7,10 €**



Bol empilable  
**59204P** Ø 14 cm - 63 cl  
**59203P** Ø 12 cm - 48 cl

**P.U.HT**  
x 12 **5,40 €**  
x 12 **3,30 €**



A



B

Bol à bouillon avec anses  
**59205P** E A - Ø 10 cm - 30 cl  
**63779P** B - Ø 10,5 cm - 30 cl

**P.U.HT**  
x 6 **5,70 €**  
x 12 **4,70 €**



A



B

Tasse à café empilable  
**59221P** E B - 9 cl

**P.U.HT**  
x 12 **2,50 €**

Tasse à thé empilable  
**59222P** E A - 18 cl  
**59223P** E B - 20 cl

**P.U.HT**  
x 12 **3,10 €**  
x 12 **3,80 €**

Tasse à déjeuner empilable  
**59224P** E A - 23 cl  
**63339P** B - 28 cl

**P.U.HT**  
x 12 **4,00 €**  
x 12 **4,60 €**



Mug empilable  
**64039P** 30 cl

**P.U.HT**  
x 12 **5,50 €**



Mug  
**62600** 45 cl  
**62601P** 36 cl

**P.U.HT**  
x 12 **6,70 €**  
x 12 **5,50 €**



Tasse à ristretto  
**1005431P** 7 cl

**P.U.HT**  
x 12 **2,00 €**



Tasse à café boule  
**63333P** 9 cl

**P.U.HT**  
x 12 **2,80 €**

Tasse à thé boule  
**63336P** 22 cl

**P.U.HT**  
x 12 **4,50 €**

Tasse à déjeuner boule  
**63337P** 28 cl

**P.U.HT**  
x 12 **5,50 €**



Sous-tasse à espresso / café  
**59226P** E Ø 13 cm

**P.U.HT**  
x 12 **1,60 €**

Sous-tasse à thé  
**59225P** E Ø 15 cm

**P.U.HT**  
x 12 **1,90 €**

Sous-tasse à déj/bouillon  
**61135P** Ø 17 cm

**P.U.HT**  
x 12 **3,00 €**



Crémier  
**59220** 35 cl  
**59219P** 25 cl  
**59218P** 15 cl

**P.U.HT**  
x 6 **6,80 €**  
x 6 **4,90 €**  
x 6 **4,50 €**



Théière avec couvercle  
**59216P** 40 cl

**P.U.HT**  
x 4 **10,50 €**



Sucrier avec couvercle  
**59228** 27 cl

**P.U.HT**  
x 6 **8,70 €**





# ONDINE

# PLAYA

## ONDINE

En porcelaine crème extra résistante. Garantie 5 ans contre les ébréchures sur les assiettes rondes : voir conditions en magasin.



### Assiette plate

Code	Dimensions	Quantité	P.U. HT
60510P	Ø 31 cm	x 6	14,40 €
60511	Ø 29 cm	x 12	11,50 €
60512P	E Ø 27 cm	x 12	8,80 €
60513P	E Ø 24 cm	x 12	6,60 €
60514P	E Ø 21 cm	x 24	5,90 €
60515P	E Ø 17 cm	x 24	4,60 €

### Assiette creuse

Code	Dimensions	Quantité	P.U. HT
60509P	E Ø 23 cm	x 12	6,20 €



### Tasse à café empilable

Code	Dimensions	Quantité	P.U. HT
60516P	E 9 cl	x 12	3,60 €

### Tasse à thé empilable

Code	Dimensions	Quantité	P.U. HT
60519P	E 23 cl	x 12	4,90 €
60518	20 cl	x 12	4,70 €
60517P	E 18 cl	x 12	4,20 €



### Sous-tasse à café

Code	Dimensions	Quantité	P.U. HT
60520P	E Ø 13 cm	x 12	3,00 €

### Sous-tasse à thé

Code	Dimensions	Quantité	P.U. HT
60521P	E Ø 15 cm	x 12	3,30 €

## PLAYA

En porcelaine crème extra résistante. Garantie 5 ans contre les ébréchures sur les pièces rondes.

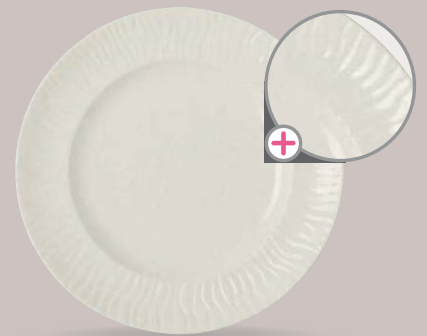

### Assiette plate ronde

Code	Dimensions	Quantité	P.U. HT
66269	Ø 31 cm	x 6	11,80 €
66292P	Ø 27 cm	x 12	7,50 €
66270P	Ø 21 cm	x 12	5,20 €



### Assiette creuse ronde

Code	Dimensions	Quantité	P.U. HT
66275	Ø 30 cm	x 6	10,90 €



### Assiette plate rectangulaire

Code	Dimensions	Quantité	P.U. HT
66274P	L. 33 x l. 23 cm	x 6	16,50 €



### Assiette plate carrée

Code	Dimensions	Quantité	P.U. HT
66272P	L. 27 x l. 27 cm	x 12	12,30 €
66273P	L. 24 x l. 24 cm	x 12	10,20 €





MÉTROPOLIS



RONDO

## Métropolis

En porcelaine crème extra résistante. Garantie 5 ans contre les ébréchures : voir conditions en magasin.

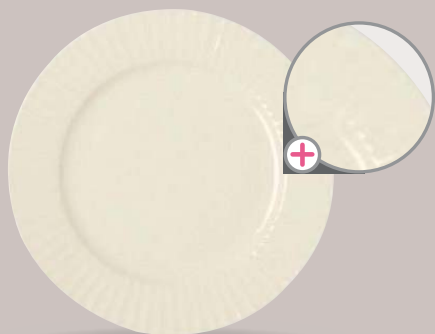

Assiette plate		📦	P.U. HT
<b>66284</b>	∅ 31 cm	x 6	<b>10,30 €</b>
<b>1002741</b>	∅ 29 cm	x 12	<b>7,60 €</b>
<b>66283P</b>	∅ 27 cm	x 12	<b>6,20 €</b>
<b>66282P</b>	∅ 24 cm	x 12	<b>4,30 €</b>
<b>1002740</b>	∅ 21 cm	x 24	<b>4,00 €</b>
<b>66281</b>	∅ 17 cm	x 24	<b>3,50 €</b>



Assiette creuse		📦	P.U. HT
<b>66280</b>	∅ 23 cm	x 12	<b>4,30 €</b>



Tasse à café		📦	P.U. HT
<b>66285P</b>	9 cl	x 12	<b>3,10 €</b>
Tasse à thé		📦	P.U. HT
<b>66287P</b>	20 cl	x 12	<b>4,90 €</b>



Sous-tasse à café		📦	P.U. HT
<b>66286P</b>	∅ 13 cm	x 12	<b>3,00 €</b>
Sous-tasse à thé		📦	P.U. HT
<b>66288P</b>	∅ 15 cm	x 12	<b>3,80 €</b>

## Rondo

En porcelaine crème extra résistante. Garantie 5 ans contre les ébréchures : voir conditions en magasin.



Assiette plate		📦	P.U. HT
<b>63282P</b>	∅ 31 cm	x 6	<b>10,60 €</b>
<b>63271P</b>	∅ 29 cm	x 12	<b>7,00 €</b>
<b>63283P</b>	E ∅ 27 cm	x 12	<b>5,60 €</b>
<b>63284P</b>	E ∅ 24 cm	x 12	<b>4,10 €</b>
<b>63285P</b>	E ∅ 21 cm	x 24	<b>3,60 €</b>
<b>63273P</b>	E ∅ 17 cm	x 24	<b>3,00 €</b>
<b>1013125P</b>	∅ 15 cm	x 24	<b>2,80 €</b>



Assiette creuse		📦	P.U. HT
<b>63411P</b>	∅ 30 cm	x 6	<b>8,40 €</b>
<b>63272P</b>	E ∅ 23 cm	x 12	<b>4,30 €</b>



Tasse à café empilable		📦	P.U. HT
<b>63286P</b>	E 9 cl	x 12	<b>2,70 €</b>
Tasse à thé empilable		📦	P.U. HT
<b>63412P</b>	E 18 cl	x 12	<b>3,50 €</b>
<b>63287P</b>	E 23 cl	x 12	<b>4,40 €</b>



Sous-tasse à café		📦	P.U. HT
<b>1002761P</b>	E ∅ 13 cm	x 12	<b>1,70 €</b>
Sous-tasse à thé		📦	P.U. HT
<b>1002762P</b>	E ∅ 15 cm	x 12	<b>1,80 €</b>

MÉTROPOLIS / RONDO



ART DE LA TABLE



## Ska

En porcelaine crème extra résistante. Garantie 5 ans contre les ébréchures : voir conditions en magasin.



Assiette plate ronde

			P.U.HT
<b>59162P</b>	∅ 28 cm	x 12	<b>7,20 €</b>
<b>59163P</b>	∅ 24 cm	x 12	<b>4,50 €</b>
<b>59164P</b>	∅ 22 cm	x 12	<b>3,90 €</b>
<b>59165P</b>	∅ 19 cm	x 24	<b>3,80 €</b>
<b>63381P</b>	∅ 15 cm	x 24	<b>3,20 €</b>



Assiette creuse ronde

			P.U.HT
<b>59166P</b>	∅ 26 cm	x 12	<b>5,70 €</b>
<b>59167P</b>	∅ 22 cm	x 12	<b>4,20 €</b>



Assiette plate carrée

			P.U.HT
<b>63382P</b>	L. 31 x l. 31 cm	x 6	<b>8,60 €</b>
<b>59155P</b>	L. 27 x l. 27 cm	x 12	<b>6,60 €</b>
<b>59156P</b>	E L. 24 x l. 24 cm	x 12	<b>4,80 €</b>
<b>59157P</b>	E L. 21 x l. 21 cm	x 12	<b>4,00 €</b>
<b>59158P</b>	E L. 19 x l. 19 cm	x 12	<b>3,60 €</b>



Assiette creuse carrée

			P.U.HT
<b>63288P</b>	L. 27 x l. 27 cm	x 12	<b>5,70 €</b>
<b>59159P</b>	E L. 21 x l. 21 cm	x 12	<b>4,60 €</b>
<b>59160P</b>	E L. 15 x l. 15 cm	x 24	<b>2,70 €</b>
<b>59161P</b>	L. 14 x l. 14 cm	x 24	<b>2,70 €</b>



Assiette entrecôte

			P.U.HT
<b>63267P</b>	L. 30 x l. 20 cm	x 6	<b>11,80 €</b>



Coupe carrée

			P.U.HT
<b>59175P</b>	E L. 16 x l. 16 x H. 4,5 cm - 30 cl	x 24	<b>5,50 €</b>
<b>70156P</b>	E L. 14 x l. 14 x H. 3,5 cm - 25 cl	x 24	<b>5,20 €</b>
<b>59174P</b>	E L. 12 x l. 12 x H. 3,5 cm - 18 cl	x 24	<b>4,60 €</b>
<b>59173P</b>	E L. 11 x l. 11 x H. 3 cm - 10 cl	x 24	<b>3,50 €</b>
<b>59172P</b>	E L. 10 x l. 10 x H. 2,5 cm - 7,5 cl	x 24	<b>3,10 €</b>



Bol rond

			P.U.HT
<b>64047P</b>	∅ 23 cm - 100 cl	x 12	<b>5,90 €</b>
<b>64045P</b>	∅ 17 cm - 45 cl	x 12	<b>5,00 €</b>



Bol

			P.U.HT
<b>59171P</b>	E ∅ 16 cm - 60 cl	x 12	<b>4,80 €</b>
<b>59170P</b>	E ∅ 13 cm - 40 cl	x 12	<b>3,30 €</b>



Ravier carré

			P.U.HT
<b>59168P</b>	E L. 11 x l. 11 x H. 3,3 cm	x 12	<b>3,70 €</b>



Ravier rectangulaire

			P.U.HT
<b>59169P</b>	E L. 15 x l. 10 x H. 3 cm	x 12	<b>4,00 €</b>



Tasse à café

			P.U.HT
<b>59176P</b>	E 9 cl	x 12	<b>2,30 €</b>

Tasse à thé

			P.U.HT
<b>59177P</b>	E 15 cl	x 12	<b>3,10 €</b>
<b>59178P</b>	E 23 cl	x 12	<b>3,90 €</b>

Tasse à déjeuner

			P.U.HT
<b>59179P</b>	E 30 cl	x 12	<b>4,40 €</b>



Sous-tasse à café

			P.U.HT
<b>59180P</b>	E L. 12 x l. 12 cm	x 12	<b>1,70 €</b>

Sous-tasse à thé

			P.U.HT
<b>59181P</b>	E L. 14 x l. 14 cm	x 6	<b>2,00 €</b>

Sous-tasse à déjeuner

			P.U.HT
<b>59182P</b>	E L. 16 x l. 16 cm	x 12	<b>2,30 €</b>



Crémier

			P.U.HT
<b>60225P</b>	15 cl	x 6	<b>3,90 €</b>



Cafetière avec couvercle

			P.U.HT
<b>60221</b>	35 cl	x 4	<b>7,90 €</b>



Théière avec couvercle

			P.U.HT
<b>60223P</b>	40 cl	x 4	<b>10,30 €</b>



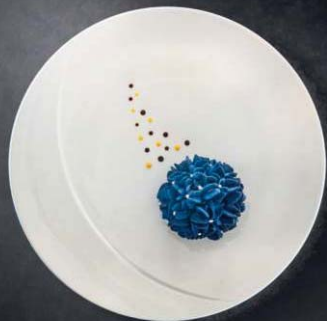

# MOON



# ÉVOLUTION

nouveau !

## Moon

En porcelaine blanche.



Assiette plate ronde

			P.U.HT
<b>1013031</b>	Ø 31 cm	x 6	<b>13,20 €</b>
<b>1013030</b>	Ø 27 cm	x 12	<b>10,10 €</b>
<b>1013032</b>	Ø 21 cm	x 12	<b>8,10 €</b>
<b>1013033</b>	Ø 11 cm	x 24	<b>5,70 €</b>



Assiette creuse ronde

			P.U.HT
<b>1013029</b>	Ø 27 cm	x 12	<b>10,10 €</b>
<b>1013028</b>	Ø 24 cm	x 12	<b>8,10 €</b>



Assiette plate carrée

			P.U.HT
<b>1013026</b>	L. 29 x l. 29 cm	x 6	<b>14,20 €</b>
<b>1013025</b>	L. 27 x l. 27 cm	x 6	<b>12,80 €</b>
<b>1013024</b>	L. 21 x l. 21 cm	x 12	<b>12,20 €</b>
<b>1013027</b>	L. 12,5 x l. 12,5 cm	x 12	<b>5,70 €</b>



Plat rectangulaire

			P.U.HT
<b>1013038</b>	L. 42 x l. 16,5 cm	x 6	<b>23,50 €</b>
<b>1013037</b>	L. 32 x l. 12,5 cm	x 12	<b>17,25 €</b>



Bol rond

			P.U.HT
<b>1013036</b>	Ø 23,2 cm - 180 cl	x 6	<b>15,25 €</b>
<b>1013035</b>	Ø 12 cm - 20 cl	x 12	<b>5,00 €</b>



Bol carré

			P.U.HT
<b>1013034</b>	L. 12,5 x l. 12,5 cm	x 12	<b>8,10 €</b>

## Évolution

En porcelaine blanche.

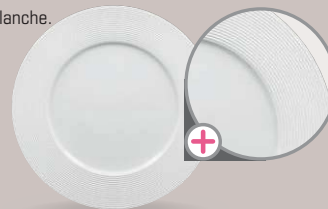

Assiette plate

			P.U.HT
<b>1013338</b>	Ø 31 cm	x 6	<b>15,25 €</b>
<b>1013339</b>	Ø 27 cm	x 12	<b>14,30 €</b>
<b>1013345</b>	Ø 22 cm	x 12	<b>9,80 €</b>
<b>1013346</b>	Ø 16 cm	x 24	<b>8,00 €</b>



Assiette gourmet

			P.U.HT
<b>1013337</b>	Ø 26 cm, Ø bassin 12,5 cm	x 6	<b>13,70 €</b>



Assiette creuse

			P.U.HT
<b>1013347</b>	Ø 23 cm	x 12	<b>11,20 €</b>



Bol rond

			P.U.HT
<b>1013340</b>	Ø 14 x H. 6,7 cm - 45 cl	x 12	<b>11,00 €</b>



Tasse à espresso

			P.U.HT
<b>1013342</b>	9 cl	x 12	<b>6,50 €</b>



Sous tasse à espresso

			P.U.HT
<b>1013343</b>	Ø 13 cm	x 12	<b>4,50 €</b>



Tasse à thé

			P.U.HT
<b>1013344</b>	20 cl	x 12	<b>8,60 €</b>



Sous tasse à thé

			P.U.HT
<b>1013341</b>	Ø 15 cm	x 12	<b>5,50 €</b>

MOON / ÉVOLUTION



ART DE LA TABLE



## Manufacture de porcelaine française depuis 200 ans

Avec la collection Canopée et ses assiettes fines et légères, les produits Pillivuyt invitent à accompagner et enrichir les gestuelles traditionnelles du service et à valoriser la relation à la dégustation.

Ils sont aussi une invitation à redécouvrir la cuisine gastronomique dans une ambiance bistro avec la collection Montmartre 1900 et une source d'inspiration pour le dressage de vos meilleurs plats avec la collection Grand Chef.





# CANOPÉE

CANOPÉE

**nouveau !**

## Canopée

En porcelaine culinaire. La gamme Canopée s'empare du plissé emblématique de Pillivuyt pour lui donner un nouveau souffle. Collection créée en collaboration avec les designers SISMO.



**Assiette plate**  
**1012583** Ø 29 cm - Bassin Ø 16 cm x 3 **P.U. HT 18,25 €**  
**1012582** Ø 25 cm - Bassin Ø 14 cm x 3 **12,10 €**

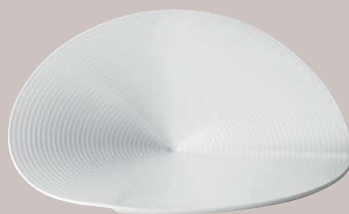

**Assiette de présentation**  
**1012580** L. 26 x l. 18 x H. 12,5 cm x 2 **P.U. HT 30,50 €**



**Coupelle avec cloche**  
**1012589** Ø 8 x H. 14,5 cm x 6 **P.U. HT 20,75 €**



**Assiette plate**  
**1012581** Ø 15,5 cm x 6 **P.U. HT 4,00 €**



**Assiette ovale**  
**1012590** L. 24,5 x l. 10,5 cm x 1 **P.U. HT 7,10 €**



**Bol**  
**1012587** Ø 12 cm x 6 **P.U. HT 7,10 €**



**Assiette creuse**  
**1012586** Ø 26 cm x 6 **P.U. HT 17,25 €**



**Cloche pour assiette ovale**  
**1012591** L. 24,5 x l. 10,5 cm x 1 **P.U. HT 17,25 €**



**Tasse à expresso**  
**1012593** 9 cl x 12 **6,00 €**  
**Tasse à expresso avec base silicone**  
**1012592** 9 cl x 12 **P.U. HT 10,10 €**



**Assiette Gourmet**  
**1012584** Ø 26,5 cm - Bassin Ø 14 cm x 1 **P.U. HT 18,25 €**



**Cloche pour assiette Gourmet**  
**1012585** Ø 14,5 cm x 1 **P.U. HT 20,25 €**



**Carafe**  
**1012588** 7 cl x 6 **P.U. HT 11,20 €**



ART DE LA TABLE

## TECK

## Teck

En porcelaine.



## Blanc



## Assiette plate

Code	Ø	Quantité	P.U. HT
1007389P	28 cm	x 3	13,30 €
1005469P	26,5 cm	x 6	10,10 €
1005470	21 cm	x 6	7,00 €
1005471	16,5 cm	x 6	5,10 €

## nouveau !

## Bronze



## Assiette plate

Code	Ø	Quantité	P.U. HT
1013332	28 cm	x 3	15,25 €
1013333	26,5 cm	x 6	10,50 €
1013334	21 cm	x 6	8,00 €
1013335	16,5 cm	x 6	5,80 €

## Bleu clair



## Assiette plate

Code	Ø	Quantité	P.U. HT
1007391	28 cm	x 3	15,25 €
1007000	26 cm	x 6	10,50 €
1007001	21 cm	x 6	8,00 €
1007002	16 cm	x 6	5,80 €



## Assiette coupe creuse

Code	Ø	Quantité	P.U. HT
1007527P	26 cm	x 6	14,30 €



## Assiette coupe creuse

Code	Ø	Quantité	P.U. HT
1013336	26 cm	x 6	15,25 €



## Assiette coupe creuse

Code	Ø	Quantité	P.U. HT
1007528	26 cm	x 6	15,25 €



## Bol

Code	Ø	Quantité	P.U. HT
1007530	15 cm	x 6	10,20 €



## Bol

Code	Ø	Quantité	P.U. HT
1007531	15 cm	x 6	11,20 €





# MONTMARTRE 1900

## Montmartre 1900

En porcelaine blanche culinaire.



### Assiette plate

	Code	Ø	x	P.U. HT
A	1009365	27 cm	6	9,20 €
A	1009361	21,5 cm	6	6,00 €
A	1009360	17 cm	6	4,30 €
B	1009366	27 cm	6	9,20 €
B	1009362	21,5 cm	6	6,00 €

### Sous-tasse à espresso

Code	Ø	x	P.U. HT
1009368	11,5 cm	12	3,20 €



### Sous-tasse à thé

Code	Ø	x	P.U. HT
1009370	15,5 cm	12	3,50 €



### Pichet

Code	Dimensions	Capacité	x	P.U. HT
1009372	9 x H. 18 cm	50 cl	2	20,75 €



### Assiette creuse

	Code	Ø	x	P.U. HT
A	1009364	26 cm	6	12,40 €
B	1009363	23 cm	6	7,40 €



### Mug

Code	Capacité	x	P.U. HT
1009371	30 cl	6	10,20 €



A



B



### Tasse à espresso forme haute

Code	Capacité	x	P.U. HT
1009367	9 cl	12	4,20 €



### Ramequin forme basse

Code	Dimensions	x	P.U. HT
1009374	9 x H. 4 cm	12	2,80 €

### Ramequin forme haute

Code	Dimensions	x	P.U. HT
1009375	9 x H. 5,8 cm	12	4,30 €

### Terrine L. 17 x l. 11,5 x H. 9,7 cm

	Code	Forme	x	P.U. HT
A	1009376	Canard	1	17,00 €
B	1009377	Lapin	1	17,00 €
	1009378	Presse - L. 12,7 x l. 7 cm	1	4,20 €



### Tasse à thé

Code	Capacité	x	P.U. HT
1009369	18 cl	12	6,50 €



### Pot avec couvercle

Code	Dimensions	x	P.U. HT
1009373	7,2 x H. 11 cm	4	9,90 €



### Panier à frites

Code	Dimensions	x	P.U. HT
1010744	L. 12,5 x l. 7 x H. 5,5 cm	6	12,40 €



# VENDÔME

## Grand Chef

En porcelaine culinaire.



Assiette plate  
1001380P Ø 30,8 cm

 **P.U.HT**  
x 3 **14,90 €**

## Vendôme

En porcelaine blanche de pâte Pillénium.

Pâte Pillénium.  
Les assiettes sont plus fines et offrent une résistance aux chocs thermiques de 20 °C supplémentaires.  
La résistance aux chocs mécaniques est multipliée de 2 à 7 fois suivant la forme des pièces.



nouveau !



A



B

Assiette dégustation  
A 1013096 Ø 30,8 cm - Bassin escargot x 3 **16,25 €**  
B 1013097 Ø 30,8 cm - Bassin rectangle x 3 **16,25 €**



Assiette carrée  
61169 L. 26 x l. 25 cm x 6 **18,75 €**  
61168 L. 16,4 x l. 14,4 cm x 6 **10,90 €**



Assiette rectangulaire  
61172 L. 34 x l. 16 cm x 4 **20,75 €**  
61171 L. 21,5 x l. 16 cm x 6 **13,20 €**



Assiette trapèze  
61173 L. 24 x l. 16,5 cm x 6 **14,90 €**



Cassiolette  
61174 L. 7,4 x l. 5,5 cm x 12 **5,00 €**  
Plateau pour cassiolette  
61177 L. 22 x l. 8,6 cm x 6 **11,30 €**  
Couvercle pour cassiolette  
61176 L. 7,4 x l. 5,5 cm x 12 **3,80 €**





BAHIA

nouveau !

**Bahia**

En grès.

Argile verte

Dune

Basalte



Assiette plate

- 1014092 Ø 29 cm
- 1014091 Ø 26 cm
- 1014089 Ø 23 cm



x 6

P.U.HT

- 18,00 €
- 11,30 €
- 9,00 €

Assiette plate

- 1014100 Ø 29 cm
- 1014099 Ø 26 cm
- 1014098 Ø 23 cm



x 6

P.U.HT

- 18,00 €
- 11,30 €
- 9,00 €

Assiette plate

- 1014108 Ø 29 cm
- 1014107 Ø 26 cm
- 1014106 Ø 23 cm



x 6

P.U.HT

- 18,00 €
- 11,30 €
- 9,00 €



Assiette gourmet

- 1014094 Ø 26 cm
- 1014093 Ø 23 cm



x 3

P.U.HT

- 16,75 €
- 15,75 €

Assiette gourmet

- 1014102 Ø 26 cm
- 1014101 Ø 23 cm



x 3

P.U.HT

- 16,75 €
- 15,75 €

Assiette gourmet

- 1014110 Ø 26 cm
- 1014109 Ø 23 cm



x 3

P.U.HT

- 16,75 €
- 15,75 €



Bol gourmet

- 1014095 30 cl



x 6

P.U.HT

- 9,60 €

Bol gourmet

- 1014103 30 cl



x 6

P.U.HT

- 9,60 €

Bol gourmet

- 1014111 30 cl



x 6

P.U.HT

- 9,60 €



Cocotte gourmet

- 1014096 50 cl



x 6

P.U.HT

- 10,60 €

Cocotte gourmet

- 1014104 50 cl



x 6

P.U.HT

- 10,60 €

Cocotte gourmet

- 1014112 50 cl



x 6

P.U.HT

- 10,60 €



Couvercle pour cocotte

- 1014097



x 6

P.U.HT

- 7,50 €

Couvercle pour cocotte

- 1014105



x 6

P.U.HT

- 7,50 €

Couvercle pour cocotte

- 1014113



x 6

P.U.HT

- 7,50 €





## Nouveau territoire d'expression

Résultat d'une collaboration avec le célèbre Editeur de design PETITE FRITURE et les designers franco-suédois Fårg & Blanche, SUCCESSION est une ligne conçue pour amener le design sur la table et dans tous les lieux qu'offre l'hôtellerie-restauration. Sa finesse et ses contrastes entre état brut et émaillé sont une invitation, aussi bien visuelle, tactile... que gustative !



REVOL



# SUCCESSION

SUCCESSION

**nouveau !**

## Succession

En porcelaine culinaire.





Saladier Ø 17 x H. 5,5 cm - 45 cl  **P.U.HT**  
**1001440** Noir x 6 **17,00 €**  
**1001439** Blanc x 6 **17,00 €**

Tasse à expresso 8 cl  **P.U.HT**  
**1002251** Noir x 6 **10,60 €**  
**1001444** Blanc x 6 **10,60 €**

Assiette plate Ø 26 cm  **P.U.HT**  
**1000212** Noir x 6 **23,25 €**  
**1000207** Blanc x 6 **23,25 €**  
 Assiette plate Ø 21 cm  **P.U.HT**  
**1000304** Noir x 6 **15,50 €**  
**1000259** Blanc x 6 **15,50 €**



Assiette creuse Ø 23 cm  **P.U.HT**  
**1000251** Noir x 6 **20,75 €**  
**1000232** Blanc x 6 **20,75 €**

Pichet Ø 12 x H. 18 cm - 75 cl  **P.U.HT**  
**1002621** Noir x 1 **32,25 €**  
**1002527** Blanc x 1 **32,25 €**

Mug 20 cl  **P.U.HT**  
**1002516** Noir x 6 **13,40 €**  
**1002428** Blanc x 6 **13,40 €**



ART DE LA TABLE

# Équinoxe

En porcelaine culinaire.



Assiette coupe plate

Noir fonte				P.U. HT
1009163	Ø 28 cm	x 6		24,50 €
1010318	Ø 26 cm	x 6		20,25 €
1010321	Ø 24 cm	x 6		19,00 €
1009164	Ø 21,5 cm	x 6		15,75 €

Bleu cirrus				P.U. HT
1009144	Ø 28 cm	x 6		26,50 €
1010320	Ø 26 cm	x 6		22,00 €
1010323	Ø 24 cm	x 6		20,50 €
1009143	Ø 21,5 cm	x 6		17,25 €

Poivre gris				P.U. HT
1009179	Ø 28 cm	x 6		24,50 €
1010319	Ø 26 cm	x 6		20,25 €
1010322	Ø 24 cm	x 6		19,00 €
1009180	Ø 21,5 cm	x 6		15,75 €

## nouveau !

Blanc cumulus				P.U. HT
1013408	Ø 28 cm	x 6		24,50 €
1013409	Ø 26 cm	x 6		20,25 €
1013410	Ø 24 cm	x 6		19,00 €
1013411	Ø 21,5 cm	x 6		15,75 €



Assiette coupe creuse Ø 27 x H. 5 cm

				P.U. HT
1009159	Noir fonte	x 4		24,25 €
1009148	Bleu cirrus	x 4		26,50 €
1009182	Poivre gris	x 4		24,25 €
1013412	Blanc cumulus	x 4		24,25 €

## nouveau !



Assiette creuse Ø 21,5 cm

				P.U. HT
1013406	Noir fonte	x 4		17,75 €
1013404	Bleu cirrus	x 4		20,50 €
1013405	Poivre gris	x 4		17,75 €
1013407	Blanc cumulus	x 4		17,75 €



Assiette rectangle L. 32,5 x l. 15 cm

				P.U. HT
1009168	Noir fonte	x 4		19,25 €
1009152	Bleu cirrus	x 4		22,25 €
1009187	Poivre gris	x 4		19,25 €
1013416	Blanc cumulus	x 4		19,25 €



Assiette ovale L. 35 x l. 22 cm

				P.U. HT
1009167	Noir fonte	x 4		23,50 €
1009151	Bleu cirrus	x 4		26,00 €
1009186	Poivre gris	x 4		23,50 €
1013415	Blanc cumulus	x 4		23,50 €



Coupelle Ø 14 x H. 2,5 cm - 20 cl

				P.U. HT
1009174	Noir fonte	x 6		11,60 €
1009147	Bleu cirrus	x 6		12,90 €
1009192	Poivre gris	x 6		11,60 €
1013419	Blanc cumulus	x 6		11,60 €



# ÉQUINOXE



Bol Ø 12 x H. 6,5 cm - 30 cl

				P.U. HT
1009170	Noir fonte	x 6		11,70 €
1009153	Bleu cirrus	x 6		13,00 €
1009189	Poivre gris	x 6		11,70 €
1013417	Blanc cumulus	x 6		11,70 €



Bol conique Ø 6,3 x H. 5 cm - 5 cl

				P.U. HT
1009172	Noir fonte	x 6		6,10 €
1009155	Bleu cirrus	x 6		7,10 €
1009191	Poivre gris	x 6		6,10 €
1013418	Blanc cumulus	x 6		6,10 €



Panier Dim Sum Ø 16 x H. 5,3 cm

				P.U. HT
1009175	Noir fonte	x 4		18,50 €
1009158	Bleu cirrus	x 4		21,25 €
1009193	Poivre gris	x 4		18,50 €
1013414	Blanc cumulus	x 4		18,50 €



Cloche Dim Sum Ø 16 x H. 7,2 cm

				P.U. HT
1009173	Noir fonte	x 2		10,90 €
1009156	Bleu cirrus	x 2		12,90 €
1009194	Poivre gris	x 2		10,90 €
1013413	Blanc cumulus	x 2		10,90 €







# ARBORESCENCE

## Arborescence

En porcelaine culinaire.



Ivoire



Poire

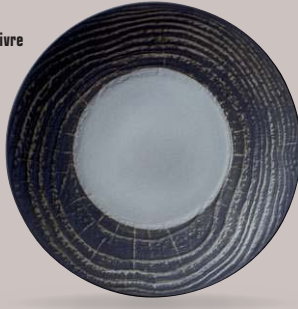

Régisse



Assiette plate

Code	Ø	Quantité	P.U. HT
1007418	Ø 31 cm	x 2	32,00 €
1007415	Ø 28,3 cm	x 6	29,50 €
1007412	Ø 26,5 cm	x 6	28,00 €
1007409	Ø 21,5 cm	x 6	19,00 €

Assiette plate

Code	Ø	Quantité	P.U. HT
1007419P	Ø 31 cm	x 2	32,00 €
1007416	Ø 28,3 cm	x 6	29,50 €
1007413	Ø 26,5 cm	x 6	28,00 €
1007410	Ø 21,5 cm	x 6	19,00 €

Assiette plate

Code	Ø	Quantité	P.U. HT
1007420P	Ø 31 cm	x 2	32,00 €
1007417	Ø 28,3 cm	x 6	29,50 €
1007414	Ø 26,5 cm	x 6	28,00 €
1007411	Ø 21,5 cm	x 6	19,00 €



Assiette coupe

Code	Ø	Quantité	P.U. HT
1007427	Ø 24,2 cm	x 6	26,25 €
1007424	Ø 19 cm	x 6	21,25 €



Assiette coupe

Code	Ø	Quantité	P.U. HT
1007428P	Ø 24,2 cm	x 6	26,25 €
1007425	Ø 19 cm	x 6	21,25 €



Assiette coupe

Code	Ø	Quantité	P.U. HT
1007429P	Ø 24,2 cm	x 6	26,25 €
1007426	Ø 19 cm	x 6	21,25 €



Coupelle

Code	Ø	Quantité	P.U. HT
1007430	Ø 7 cm	x 6	8,00 €



Coupelle

Code	Ø	Quantité	P.U. HT
1007431	Ø 7 cm	x 6	8,00 €



Coupelle

Code	Ø	Quantité	P.U. HT
1007432	Ø 7 cm	x 6	8,00 €



Assiette rectangulaire

Code	L.	Quantité	P.U. HT
1007436	L. 30,2 x l. 15,3 cm	x 6	23,50 €

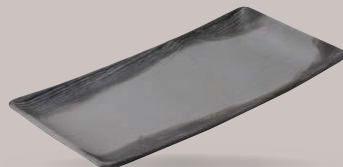

Assiette rectangulaire

Code	L.	Quantité	P.U. HT
1007437	L. 30,2 x l. 15,3 cm	x 6	23,50 €



Assiette rectangulaire

Code	L.	Quantité	P.U. HT
1007438	L. 30,2 x l. 15,3 cm	x 6	23,50 €



Gobelet

Code	Cl.	Quantité	P.U. HT
1010504	18 cl	x 6	11,60 €
1007433	8 cl	x 6	10,50 €



Gobelet

Code	Cl.	Quantité	P.U. HT
1010506	18 cl	x 6	11,60 €
1007434	8 cl	x 6	10,50 €

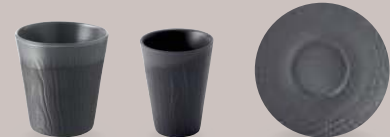

Gobelet

Code	Cl.	Quantité	P.U. HT
1010505	18 cl	x 6	11,60 €
1007435	8 cl	x 6	10,50 €

Sous-tasse pour gobelet 8 cl

Code	Ø	Quantité	P.U. HT
1002685	Ø 14 cm	x 6	12,30 €

Sous-tasse pour gobelet 8 cl

Code	Ø	Quantité	P.U. HT
1002687	Ø 14 cm	x 6	12,30 €

Sous-tasse pour gobelet 8 cl

Code	Ø	Quantité	P.U. HT
1002686	Ø 14 cm	x 6	12,30 €

ARBORESCENCE



ART DE LA TABLE



## Basalt

Basalt a toutes les qualités culinaires de la porcelaine et l'esthétique de l'ardoise.



Assiette à steak  
**66126P** L. 33 x l. 24 cm x 3 **P.U.HT 21,50 €**

Assiette ronde  
**69797P** Ø 32 cm x 2 **P.U.HT 20,75 €**  
**1002538** Ø 28,5 cm x 4 **P.U.HT 18,00 €**

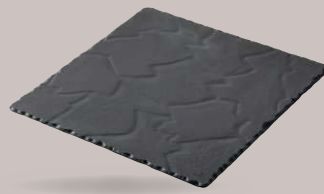

Plateau bambou seul pour assiette 66126  
**1001167P** L. 27,5 x l. 28 x H. 2 cm x 3 **P.U.HT 21,50 €**

Plateau carré  
**68690P** L. 25 x l. 25 cm x 6 **P.U.HT 17,00 €**  
**1001160P** L. 20 x l. 20 cm x 6 **P.U.HT 12,30 €**  
**70000P** L. 15 x l. 15 cm x 6 **P.U.HT 6,70 €**

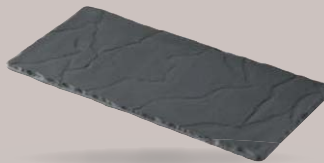

Assiette à steak  
**1002539P** L. 33 x l. 22 cm, 1 bord relevé x 3 **P.U.HT 19,50 €**

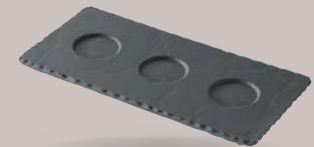

Plateau rectangulaire  
**1012600P** L. 40 x l. 30 cm x 2 **P.U.HT 32,50 €**  
**69211P** L. 30 x l. 20 cm x 6 **P.U.HT 16,75 €**  
**66025P** L. 30 x l. 16 cm x 6 **P.U.HT 11,60 €**  
**66024** L. 30 x l. 11 cm x 6 **P.U.HT 10,30 €**  
**66023P** L. 25 x l. 12 cm x 6 **P.U.HT 9,30 €**  
**1001166** L. 20 x l. 10 cm x 6 **P.U.HT 8,30 €**

Plateau  
**66321P** L. 25 x l. 12 cm - 1 encoche x 6 **P.U.HT 9,60 €**  
**66026P** L. 25 x l. 12 cm - 3 encoches x 6 **P.U.HT 9,30 €**

Assiette burger  
**69798P** L. 33 x l. 20 cm, 2 bords relevés x 3 **P.U.HT 19,50 €**



Assiette à steak  
**69799P** L. 39,5 x l. 24 cm, 2 bords relevés x 4 **P.U.HT 23,50 €**

Assiette rectangle  
**70001P** L. 33,2 x l. 20 cm, 1 bord relevé x 3 **P.U.HT 19,50 €**



Sous-tasse café/thé gourmand  
**1002541P** L. 29 x l. 13,4 cm x 6 **P.U.HT 11,70 €**

BASALT



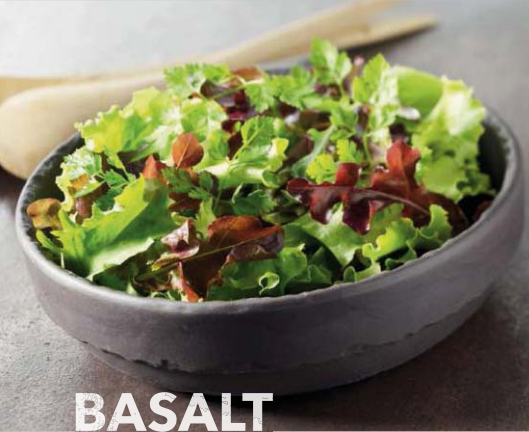

# BASALT

## Basalt

En pâte porcelaine teintée.



# CLUB

## Club

En porcelaine noire.



## Impulse

En porcelaine.



Saladier  
✓ **1001165P** Ø 17 x H. 5,5 cm - 70 cl x 4 **P.U. HT 9,80 €**



Bol  
✓ **1001164P** Ø 10 x H. 6 cm - 25 cl x 6 **P.U. HT 6,80 €**



Petit bol  
✓ **70002P** Ø 7,5 x H. 4,5 cm - 8 cl x 6 **P.U. HT 5,60 €**



Bol XXS  
**1001163P** Ø 5 x H. 3,5 cm - 3 cl x 6 **P.U. HT 3,90 €**



Assiette carrée creuse  
**1005603** L. 20,4 x l. 20,2 cm x 4 **P.U. HT 16,00 €**



Assiette rectangulaire  
**1002561P** L. 36 x l. 21 cm x 4 **P.U. HT 19,75 €**  
**1002563P** L. 36 x l. 15 cm x 4 **P.U. HT 17,15 €**  
**1006354** L. 24 x l. 12,5 cm x 6 **P.U. HT 13,90 €**



Plat rectangulaire  
**1006681** L. 20,7 x l. 14,4 cm x 6 **P.U. HT 11,70 €**



Ravier  
**1006356P** L. 14,5 x l. 14 x H. 6 cm - 30 cl x 4 **P.U. HT 10,00 €**  
**1010507** L. 13 x l. 12,5 x H. 4 cm - 25 cl x 12 **P.U. HT 8,70 €**



Bol blanc  
**65771** L. 14 x l. 12 x H. 10 cm - 45 cl x 4 **P.U. HT 11,70 €**  
**65758P** L. 12 x l. 10 x H. 9 cm - 25 cl x 4 **P.U. HT 9,10 €**



Mini pot  
**65754P** L. 8,5 x l. 7 cm - 8 cl - Blanc x 6 **P.U. HT 6,00 €**  
**65755** L. 8,5 x l. 7 cm - 8 cl - Ardoise x 6 **P.U. HT 7,00 €**  
**65753** L. 7 x l. 6 cm - 5 cl - Blanc x 6 **P.U. HT 5,40 €**

## Froissé

En porcelaine.



Ramequin  
**1005562** Ø 10 x H. 4,5 cm - 17 cl x 6 **P.U. HT 4,50 €**



Bol profond  
**1002515P** Ø 11,5 x H. 7 cm - 25 cl x 6 **P.U. HT 6,00 €**



# Solid

En porcelaine culinaire.



nouveau !



Assiette creuse Ø 27 x H. 4,5 cm

			P.U.HT
1005450	Blanc	x 4	25,50 €
1005463	Rouge	x 4	25,50 €
1005588	Noir	x 4	25,50 €



Assiette coupe creuse

Ø 23,5 x H. 4,5 cm

			P.U.HT
1007512	Noir brillant	x 4	21,50 €
1007514	Blanc	x 4	21,50 €
1007513	Rouge piment	x 4	21,50 €

Ø 17,5 x H. 4,5 cm

			P.U.HT
1005535	Blanc	x 6	15,25 €
1005537	Rouge	x 6	15,25 €
1005536	Noir	x 6	15,25 €



Pot à tapas Ø 8 x H. 6 cm - 15 cl

			P.U.HT
1005552	Blanc	x 6	8,00 €
1005554	Rouge	x 6	8,00 €
1005553	Noir	x 6	8,00 €



Plateau rectangulaire noir L. 31 x l. 11 x H. 2 cm

			P.U.HT
1006210		x 4	10,80 €



SOLID



Soupière Ø 12,3 x H. 10,5 cm - 45 cl

			P.U.HT
1005556	Blanc	x 6	14,90 €
1003332	Rouge	x 6	14,90 €
1003331	Noir	x 6	14,90 €



Bol Blanc

			P.U.HT
1005540	Ø 11 x H. 6,7 cm - 30 cl	x 6	10,30 €
1005546	Ø 5 x H. 3,5 cm - 3 cl	x 6	5,50 €

Bol Rouge

			P.U.HT
1005542	Ø 11 x H. 6,7 cm - 30 cl	x 6	10,30 €
1005548	Ø 5 x H. 3,5 cm - 3 cl	x 6	5,50 €

Bol Noir

			P.U.HT
1005541	Ø 11 x H. 6,7 cm - 30 cl	x 6	10,30 €
1005547	Ø 5 x H. 3,5 cm - 3 cl	x 6	5,50 €



Mise en bouche Ø 7,5 x H. 5,3 cm - 4 cl

			P.U.HT
1002637	Blanc	x 6	8,90 €
1002642	Rouge	x 6	8,90 €
1002638	Noir	x 6	8,90 €



Couppelle creuse ovale

			P.U.HT
1002645	L. 27,3 x l. 5 x H. 2 cm	x 6	6,80 €
1002644	L. 15 x l. 5 x H. 2 cm	x 6	5,50 €
1002643	L. 8,5 x l. 5 x H. 2 cm	x 6	4,50 €



LIKID

# Likid

En porcelaine culinaire.



Saucière H. 10 cm - 10 cl

			P.U.HT
1001221P	Blanc	x 4	8,70 €
1002684	Rouge	x 4	10,00 €
1002656P	Ardoise	x 4	10,00 €



Pichet blanc

			P.U.HT
1001217	H. 16,2 cm - 50 cl	x 4	14,80 €
1001215	H. 13 cm - 25 cl	x 4	11,50 €

Pichet rouge

			P.U.HT
1001218	H. 16,2 cm - 50 cl	x 4	17,00 €
1001216	H. 13 cm - 25 cl	x 4	13,30 €

Pichet ardoise

			P.U.HT
1002658	H. 16,2 cm - 50 cl	x 4	17,00 €
1002659	H. 13 cm - 25 cl	x 4	13,30 €



Set salière / poivrière H. 8,5 cm

			P.U.HT
1002668	Blanc / Ardoise	x 1	22,00 €



Moutardier / Ketchup avec couvercle et spatule

H. 9 cm - 15 cl

			P.U.HT
1002662	Blanc	x 4	12,30 €
1002663	Ardoise	x 4	12,80 €



Huillier / Vinaigrier - ardoise H. 16,5 cm - 25 cl

			P.U.HT
1002665	A - Vinaigrier	x 2	19,50 €
1002748	B - Huillier	x 2	19,50 €





MEALPLAK

nouveau !

## Mealplak

En résine.



Plateau 3 encoches L. 18 x l. 7 x H. 1 cm

**1013166** Blanc x 8 **P.U.HT 17,25 €**



Plateau 5 encoches L. 29,5 x l. 7 x H. 1 cm

**1013167** Blanc x 8 **P.U.HT 27,50 €**

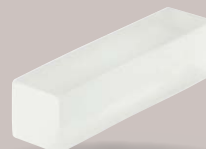

Barrette L. 16,5 x l. 4 x H. 4 cm

**1013186** Blanc x 4 **P.U.HT 29,25 €**



Plateau sel et poivre L. 12,5 x l. 8,5 x H. 2 cm

**1013185** Blanc x 4 **P.U.HT 23,00 €**



Bloc à beurre L. 7 x l. 7 x H. 2 cm

**1013184** Blanc x 8 **P.U.HT 16,00 €**



Assiette Gourmet Ø 15 x H. 4 cm

**1013183** Blanc x 2 **P.U.HT 44,25 €**

Planche à tapas L. 30 x l. 7 x H. 1 cm

			P.U.HT
<b>1013175</b>	Blanc	x 8	<b>23,75 €</b>
<b>1013176</b>	Rouge	x 8	<b>23,75 €</b>
<b>1013177</b>	Grège	x 8	<b>23,75 €</b>
<b>1013178</b>	Citron	x 8	<b>23,75 €</b>
<b>1013179</b>	Mandarine	x 8	<b>23,75 €</b>
<b>1013180</b>	Lagon	x 8	<b>23,75 €</b>
<b>1013181</b>	Framboise	x 8	<b>23,75 €</b>

Plateau pour mignardises L. 24,5 x l. 19 x H. 1 cm

			P.U.HT
<b>1013168</b>	Blanc	x 8	<b>21,75 €</b>
<b>1013169</b>	Rouge	x 8	<b>21,75 €</b>
<b>1013170</b>	Grège	x 8	<b>21,75 €</b>
<b>1013171</b>	Citron	x 8	<b>21,75 €</b>
<b>1013172</b>	Mandarine	x 8	<b>21,75 €</b>
<b>1013173</b>	Lagon	x 8	<b>21,75 €</b>
<b>1013174</b>	Framboise	x 8	<b>21,75 €</b>

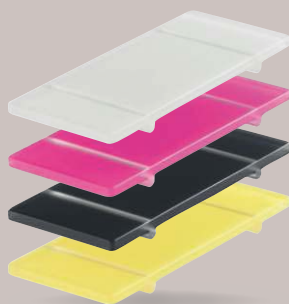

Plateau avec pied L. 24,5 x l. 10 x H. 1,5 cm

			P.U.HT
<b>1012162</b>	Blanc	x 8	<b>22,50 €</b>
<b>1012164</b>	Framboise	x 8	<b>22,50 €</b>
<b>1012161</b>	Anthracite	x 8	<b>22,50 €</b>
<b>1012163</b>	Citron	x 8	<b>22,50 €</b>



Présentoir L. 25 x l. 15 x H. 21 cm

			P.U.HT
<b>1013182</b>	Blanc	x 2	<b>120,00 €</b>





## Ripple

Ariane, c'est le mariage d'une porcelaine blanche éclatante et pure, fine et élégante qui répond aux besoins du monde de l'hôtellerie et de la gastronomie.

RIPPLE illustre le raffinement et apportera une touche de créativité sans rien concéder à la résistance. Son relief évoque le subtil mouvement de l'eau.



**Ariane**  
— fine porcelain —



Ariane



# SPLASH



# VITAL

SPLASH / VITAL

## Splash

En porcelaine.



Assiette plate surélevée			<b>P.U.HT</b>
<b>1010284P</b>	∅ 29 cm	x 6	<b>12,50 €</b>
<b>1010285P</b>	∅ 27 cm	x 12	<b>10,40 €</b>
<b>1010286P</b>	∅ 21 cm	x 12	<b>7,30 €</b>



Assiette creuse surélevée			<b>P.U.HT</b>
<b>1010287P</b>	∅ 21 cm	x 4	<b>13,20 €</b>



Coupelle			<b>P.U.HT</b>
<b>1010288P</b>	∅ 14 cm	x 8	<b>11,30 €</b>

nouveau !

## Vital

En porcelaine crème.



Assiette plate surélevée			<b>P.U.HT</b>
<b>1005631</b>	∅ 29 cm	x 6	<b>8,20 €</b>
<b>1005632</b>	∅ 27 cm	x 12	<b>6,40 €</b>
<b>1005633</b>	∅ 21 cm	x 12	<b>4,30 €</b>



Assiette creuse surélevée			<b>P.U.HT</b>
<b>1005634</b>	∅ 21 cm	x 4	<b>11,30 €</b>



Coupelle			<b>P.U.HT</b>
<b>1006416</b>	∅ 14 cm	x 8	<b>8,50 €</b>



ART DE LA TABLE



ARTISAN



## Artisan

En porcelaine.

Crème



Pebble



Assiette coupe plate  
**1011151** Ø 30 cm x 6  
**1010774P** Ø 27 cm x 6  
**1013422P** Ø 21 cm x 12  
**1010777P** Ø 17 cm x 12

**P.U.HT**  
**9,40 €**  
**7,30 €**  
**5,90 €**  
**4,10 €**

Assiette rectangulaire  
**1010789** L 36 x l 20 cm x 6

**P.U.HT**  
**17,75 €**

Assiette coupe plate  
**1011149** Ø 30 cm x 6  
**1010772P** Ø 27 cm x 6  
**1013420P** Ø 21 cm x 12  
**1010775P** Ø 17 cm x 12

**P.U.HT**  
**13,60 €**  
**11,80 €**  
**9,30 €**  
**6,20 €**

Assiette rectangulaire  
**1010787** L 36 x l 20 cm x 6 **P.U.HT**  
**23,75 €**



Assiette coupe creuse  
**1010783P** Ø 25 cm x 6

**P.U.HT**  
**10,40 €**

Cupelle empilable  
**1011154** Ø 12 cm x 6

**P.U.HT**  
**5,20 €**

Assiette coupe creuse  
**1010781P** Ø 25 cm x 6

**P.U.HT**  
**14,60 €**

Cupelle empilable  
**1011152** Ø 12 cm x 6 **P.U.HT**  
**6,90 €**

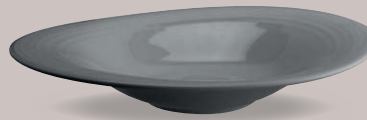

Assiette Gourmet  
**1010780** Ø 29 cm x 6

**P.U.HT**  
**10,40 €**

Cupelle conique  
**1010786P** Ø 11 cm x 6

**P.U.HT**  
**5,20 €**

Assiette Gourmet  
**1010778** Ø 29 cm x 6

**P.U.HT**  
**15,75 €**

Cupelle conique  
**1010784P** Ø 11 cm x 6 **P.U.HT**  
**6,90 €**

nouveau !



Assiette plate  
**1014086P** Ø 27 cm x 6 **P.U.HT**  
**9,00 €**  
**1014084P** Ø 21 cm x 12 **7,00 €**

nouveau !



Assiette plate  
**1014087P** Ø 27 cm x 6 **P.U.HT**  
**12,90 €**  
**1014085P** Ø 21 cm x 12 **10,00 €**







## Artisan

En porcelaine.



nouveau !

Rouge



Assiette coupe plate

**1013041** Ø 30 cm  
**1013042** Ø 27 cm  
**1013423** Ø 21 cm  
**1013043** Ø 17 cm



x 6  
x 6  
x 12  
x 12

P.U.HT

**13,60 €**  
**10,90 €**  
**10,50 €**  
**6,20 €**



Assiette coupe creuse

**1013045** Ø 25 cm



x 6

P.U.HT

**14,60 €**



Assiette gourmet

**1013044** Ø 29 cm



x 6

P.U.HT

**15,75 €**



Assiette rectangulaire

**1013048** L. 36 x l. 20 cm



x 6

P.U.HT

**23,75 €**



Coupelle empilable

**1013046** Ø 12 cm



x 6

P.U.HT

**6,90 €**



Coupelle conique

**1013047** Ø 11 cm



x 6

P.U.HT

**6,90 €**

Coast



Assiette coupe plate

**1011150** Ø 30 cm  
**1010773P** Ø 27 cm  
**1013421** Ø 21 cm  
**1010776P** Ø 17 cm



x 6  
x 6  
x 12  
x 12

P.U.HT

**13,60 €**  
**10,90 €**  
**10,50 €**  
**6,20 €**



Assiette coupe creuse

**1010782P** Ø 25 cm



x 6

P.U.HT

**14,60 €**



Assiette Gourmet

**1010779** Ø 29 cm



x 6

P.U.HT

**15,75 €**



Assiette rectangulaire

**1010788** L. 36 x l. 20 cm



x 6

P.U.HT

**23,75 €**



Coupelle empilable

**1011153** Ø 12 cm



x 6

P.U.HT

**6,90 €**



Coupelle conique

**1010785P** Ø 11 cm



x 6

P.U.HT

**6,90 €**



SLATE



SAND



COUPE



nouveau !

## Slate

En porcelaine très résistante.

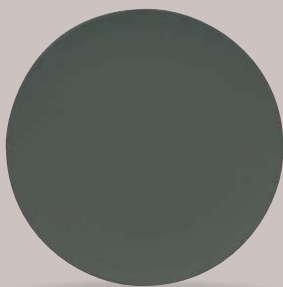

Assiette coupe plate

	∅	x	P.U.HT
<b>1012576P</b>	28 cm	x 6	<b>9,90 €</b>
<b>1012577P</b>	25 cm	x 6	<b>6,90 €</b>
<b>1012578P</b>	22 cm	x 6	<b>5,90 €</b>



Assiette coupe creuse

	∅	x	P.U.HT
<b>1012579P</b>	25 cm	x 6	<b>16,90 €</b>

## Sand

En porcelaine très résistante.

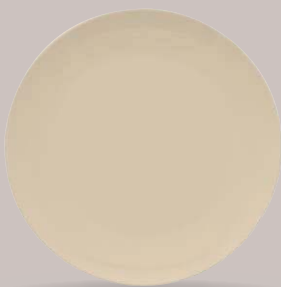

Assiette coupe plate

	∅	x	P.U.HT
<b>1012572P</b>	28 cm	x 6	<b>9,90 €</b>
<b>1012573P</b>	25 cm	x 6	<b>6,90 €</b>
<b>1012574P</b>	22 cm	x 6	<b>5,90 €</b>



Assiette coupe creuse

	∅	x	P.U.HT
<b>1012575P</b>	25 cm	x 6	<b>16,90 €</b>

## Coupe

En porcelaine extra blanche, extra résistante..



Assiette coupe plate

	∅	x	P.U.HT
<b>1006752P</b>	31 cm	x 4	<b>10,00 €</b>
<b>1006753P</b>	28 cm	x 6	<b>6,30 €</b>
<b>1006754P</b>	25 cm	x 6	<b>4,80 €</b>
<b>1006755P</b>	22 cm	x 6	<b>3,80 €</b>
<b>1006756P</b>	17 cm	x 12	<b>3,60 €</b>
<b>1009198P</b>	15 cm	x 24	<b>3,50 €</b>



Assiette coupe plate ovale

	L.	x	P.U.HT
<b>1006757P</b>	33 cm	x 4	<b>10,10 €</b>
<b>1006758P</b>	23 cm	x 6	<b>5,60 €</b>



Assiette coupe creuse

	∅	x	P.U.HT
<b>1010324P</b>	28 cm	x 4	<b>11,90 €</b>
<b>1006771P</b>	25 cm	x 6	<b>9,50 €</b>
<b>1006772P</b>	20 cm	x 6	<b>8,10 €</b>
<b>1006773P</b>	15 cm	x 12	<b>7,70 €</b>





RIPPLE



JUNGLE

BRUSHWOOD



RIPPLE / JUNGLE / BRUSHWOOD

nouveau !

### Ripple

En porcelaine blanche extra résistante.

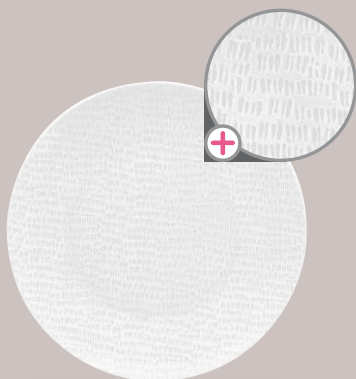

Assiette coupe plate

			P.U. HT
<b>1012564P</b>	Ø 28 cm	x 6	<b>9,90 €</b>
<b>1012565P</b>	Ø 25 cm	x 6	<b>6,90 €</b>
<b>1012566P</b>	Ø 22 cm	x 6	<b>5,90 €</b>



Assiette coupe creuse

			P.U. HT
<b>1012567P</b>	Ø 25 cm	x 6	<b>16,90 €</b>

### Jungle

En porcelaine blanche extra résistante.

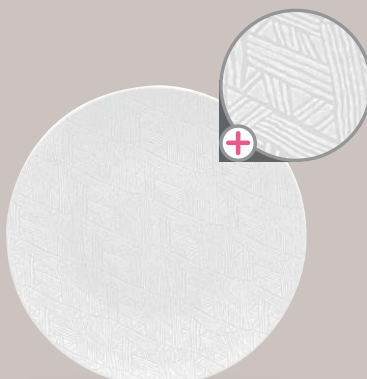

Assiette coupe plate

			P.U. HT
<b>1012568P</b>	Ø 28 cm	x 6	<b>9,90 €</b>
<b>1012569P</b>	Ø 25 cm	x 6	<b>6,90 €</b>
<b>1012570P</b>	Ø 22 cm	x 6	<b>5,90 €</b>



Assiette coupe creuse

			P.U. HT
<b>1012571P</b>	Ø 25 cm	x 6	<b>16,90 €</b>

### Brushwood

En porcelaine blanche extra résistante.



Assiette coupe plate

			P.U. HT
<b>1013477P</b>	Ø 28 cm	x 6	<b>9,90 €</b>
<b>1013478P</b>	Ø 25 cm	x 6	<b>8,90 €</b>
<b>1013479P</b>	Ø 22 cm	x 6	<b>5,90 €</b>



Assiette coupe creuse

			P.U. HT
<b>1013480P</b>	Ø 25 cm	x 6	<b>9,60 €</b>



# STYLE

## Style

En porcelaine extra blanche.



### Assiette plate

Code	Ø	Quantité	P.U. HT
1006742P	Ø 31 cm	x 4	14,60 €
1006743P	Ø 28 cm	x 6	13,40 €
1006744P	Ø 25 cm	x 6	12,40 €
1006745P	Ø 22 cm	x 6	9,30 €
1006746P	Ø 17 cm	x 12	8,10 €

### Assiette plate

Code	Ø	Quantité	P.U. HT
1008500P	Ø 31 cm	x 4	18,25 €
1008499P	Ø 28 cm	x 6	14,30 €
1008498P	Ø 25 cm	x 6	13,30 €
1008497P	Ø 22 cm	x 6	11,10 €



### Assiette creuse

Code	Ø	Quantité	P.U. HT
1006759P	Ø 30 cm	x 4	16,00 €
1006760P	Ø 25 cm	x 4	10,50 €



### Assiette plate gourmet

Code	Ø	Quantité	P.U. HT
1006750P	Ø 28 cm	x 6	14,40 €
1006751	Ø 22 cm	x 6	12,40 €



### Assiette gourmet

Code	Ø	Quantité	P.U. HT
1006747P	Ø 28 cm	x 6	14,50 €
1006748P	Ø 22 cm	x 6	12,50 €



### Cloche seule pour assiette gourmet

Code	Ø	Quantité	P.U. HT
1006775	Ø 28 cm	x 1	14,30 €
1006776	Ø 22 cm	x 1	13,90 €



### Saladier

Code	Ø	Quantité	P.U. HT
1006780P	Ø 24 cm	x 6	14,60 €
1006781P	Ø 21 cm	x 6	13,60 €
1006782P	Ø 16 cm	x 6	12,20 €



### Bol

Code	Ø	Quantité	P.U. HT
1006768P	Ø 16 cm	x 6	12,80 €
1006769P	Ø 14 cm	x 6	10,40 €
1006770P	Ø 12 cm	x 12	7,40 €



### Tasse à espresso

Code	Quantité	P.U. HT
1006761P	9 cl	5,90 €



### Tasse à thé

Code	Volume	Quantité	P.U. HT
1006763P	20 cl	x 12	7,70 €



### Tasse à déjeuner

Code	Volume	Quantité	P.U. HT
1006765P	27 cl	x 6	8,00 €



### Tasse à bouillon avec anses

Code	Volume	Quantité	P.U. HT
1006766	30 cl	x 1	10,10 €



### Sous-tasse à espresso

Code	Ø	Quantité	P.U. HT
1006762P	Ø 14 cm	x 24	4,00 €

### Sous-tasse à thé

Code	Ø	Quantité	P.U. HT
1006764P	Ø 16 cm	x 24	5,20 €

### Sous-tasse à déjeuner / bouillon

Code	Ø	Quantité	P.U. HT
1006767P	Ø 18 cm	x 6	5,90 €



### Mug

Code	Volume	Quantité	P.U. HT
1006779P	30 cl	x 6	6,90 €



### Théière avec couvercle

Code	Volume	Quantité	P.U. HT
1006784P	40 cl	x 2	21,00 €



### Crémier

Code	Volume	Quantité	P.U. HT
1006777	25 cl	x 6	11,10 €
1006778P	15 cl	x 6	9,90 €



### Sucrier avec couvercle

Code	Volume	Quantité	P.U. HT
1006783P	20 cl	x 6	13,50 €

## Style Ethnic

En porcelaine extra blanche. STYLE ETHNIC est une déclinaison de la ligne STYLE rehaussée d'un relief très fin sur l'aile.



### Assiette plate

Code	Ø	Quantité	P.U. HT
1008500P	Ø 31 cm	x 4	18,25 €
1008499P	Ø 28 cm	x 6	14,30 €
1008498P	Ø 25 cm	x 6	13,30 €
1008497P	Ø 22 cm	x 6	11,10 €



# MOVING

## Moving

En porcelaine extra blanche.

nouveau !



Assiette ovale

**1012562P** L. 34 x l. 24 cm x 4 **16,00 €**  
**1012563P** L. 27 x l. 20 cm x 4 **10,50 €**



Assiette plate

**1008394P** Ø 29 cm x 4 **12,70 €**  
**1008395P** Ø 27 cm x 6 **11,10 €**  
**1008398P** Ø 25 cm x 6 **10,10 €**  
**1008399P** Ø 22 cm x 6 **9,50 €**



Assiette coupe creuse

**1008396P** Ø 24 cm x 4 **12,70 €**



Bol

**1008397** Ø 12 x H. 6 cm x 6 **10,50 €**



# FRAME

## Frame

En porcelaine extra blanche.



Assiette plate

**1008505P** Ø 29 cm x 4 **10,00 €**  
**1008504P** Ø 27 cm x 6 **7,40 €**  
**1008503P** Ø 24 cm x 6 **5,20 €**  
**1008502P** Ø 21 cm x 6 **4,90 €**  
**1008501** Ø 17 cm x 12 **4,20 €**



Assiette gourmet

**1008509P** Ø 30 cm x 4 **10,90 €**



Assiette plate ovale

**1008506P** L. 32 x l. 22 cm x 4 **12,80 €**



Petit pot

**1008507P** Ø 6 x H. 3,5 cm x 12 **2,70 €**



Coupelle

**1008508P** Ø 12 x H. 4 cm x 12 **5,30 €**

## Smooth

Porcelaine extra blanche.



Assiette ultra plate

**1008383P** Ø 29 cm x 6 **12,70 €**

MOVING / FRAME / SMOOTH



ART DE LA TABLE



ART DE LA TABLE

# DELISSÉA

nouveau !

## Delisséa



En porcelaine blanche. Le designer Arnaud Baratte vous présente DELISSÉA, fruit de plusieurs mois de recherche et d'un savoir-faire spécifique. La forme, la taille, l'épaisseur de la porcelaine, la prise en main ont été pensées dans les moindres détails, intérieurs comme extérieurs. Unique au monde, DELISSÉA vous offre un moment rare de volupté et de plaisir où le mot «dégustation» prend tout son sens. La spirale intérieure favorise l'aération, la libération de tous les arômes. Le fond de tasse concave permet une double oxygénation permettant une belle texture de mousse. Un écrin d'exception pour une évocation des sens.



Tasse à espresso  
**1013471P** 9 cl x 6 **P.U.HT 5,90 €**



Sous tasse à espresso  
**1013475P** 13 cm x 6 **P.U.HT 4,90 €**



Tasse à thé/chocolat  
**1013473P** 23 cl x 6 **P.U.HT 6,90 €**



Tasse à lungo  
**1013472P** 20 cl x 6 **P.U.HT 7,90 €**



Sous tasse à lungo / thé  
**1013476P** 13 cm x 6 **P.U.HT 4,90 €**



Mug  
**1013474P** 30 cl x 6 **P.U.HT 8,00 €**



# SNACK

## Snack

En porcelaine extra blanche.

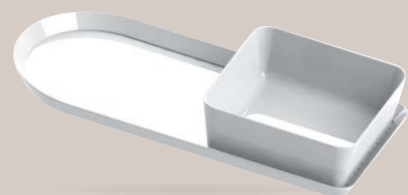

Assiette ovale  
**1008382P** L. 32 x l. 14 x H. 2 cm x 6 **P.U.HT 10,50 €**

Bol carré  
**1008384P** L. 13,6 x l. 13,6 x H. 5 cm x 6 **P.U.HT 7,40 €**



Bol  
**1008385P** Ø 14,8 cm x H. 7 cm x 6 **P.U.HT 6,90 €**

## Quadra

En porcelaine extra blanche.

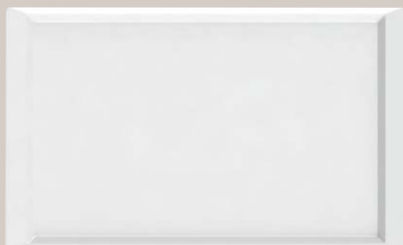

Assiette plate rectangulaire  
**1008392P** L. 36 x l. 22 cm x 6 **P.U.HT 10,10 €**  
**1008393P** L. 28 x l. 16 cm x 6 **P.U.HT 9,30 €**



Assiette plate carrée  
**1008388P** L. 27 x l. 27 cm x 6 **P.U.HT 9,90 €**  
**1008389P** L. 24 x l. 24 cm x 6 **P.U.HT 8,80 €**  
**1008390P** L. 21 x l. 21 cm x 6 **P.U.HT 7,70 €**



Assiette creuse carrée  
**1008391P** L. 23 x l. 23 cm x 6 **P.U.HT 8,70 €**



# SPHÈRE

## Sphère

En porcelaine blanche.



Sphère avec couvercle  
**1008386P** Ø 18 cm x H. 16 cm x 1 **P.U.HT 23,50 €**



# BRASSERIE

## Brasserie

En porcelaine extra blanche.



Assiette plate

		P.U. HT
1006688P	Ø 31 cm x 4	8,10 €
1006689P	Ø 29 cm x 4	6,30 €
1006690P	Ø 27 cm x 6	5,10 €
1006691P	Ø 24 cm x 6	3,70 €
1006692P	Ø 21 cm x 6	3,40 €
1006693P	Ø 17 cm x 12	2,90 €
1006694P	Ø 15 cm x 6	2,60 €



Bol empilable

		P.U. HT
1006718	Ø 18 cm x 6	8,10 €
1006719P	Ø 16 cm x 6	6,40 €
1006720P	Ø 14 cm x 6	5,70 €



Tasse à espresso empilable

		P.U. HT
1006702P	E 9 cl x 12	2,40 €

Tasse à thé empilable

		P.U. HT
1006705P	22 cl x 12	4,10 €
1006706P	20 cl x 12	3,80 €
1006707P	E 18 cl x 12	3,40 €

Tasse à déjeuner empilable

		P.U. HT
1006709P	E 28 cl x 6	4,90 €



Crémier

		P.U. HT
A 1006728	35 cl x 4	7,20 €
A 1006729	20 cl x 6	5,30 €
B 1006721P	10 cl x 6	4,70 €



Bol à bouillon avec anses

		P.U. HT
1006716P	30 cl x 6	5,70 €



Sous-tasse à espresso

		P.U. HT
1006710P	E Ø 13 cm x 24	1,60 €

Sous-tasse à thé

		P.U. HT
1006715P	E Ø 15 cm x 24	2,00 €

Sous-tasse à déjeuner

		P.U. HT
1006714P	E Ø 17 cm x 12	3,40 €



Sucrier empilable avec couvercle

		P.U. HT
1006735	20 cl x 6	8,30 €

Couvercle seul pour sucrier

		P.U. HT
1006736	15 cl x 12	4,70 €



Assiette plate ovale

		P.U. HT
1006698P	L 38 x l. 26 cm x 4	10,50 €
1006699P	L 32 x l. 23 cm x 4	9,10 €
1006700	L 22 x l. 16 cm x 6	7,10 €



Bol à bouillon empilable

		P.U. HT
1006717P	30 cl x 6	5,00 €



Mug empilable

		P.U. HT
1006722P	30 cl x 6	5,20 €



Sous tasse à café/thé gourmand

		P.U. HT
1006711P	Ø 17 cm x 12	3,30 €
1006712	Ø 19 cm x 12	3,80 €
1006713P	Ø 21 cm x 12	4,40 €



Assiette creuse

		P.U. HT
1006695P	Ø 29 cm x 4	7,70 €
1006696P	Ø 26 cm x 6	5,40 €
1006697P	E Ø 23 cm x 6	3,40 €



Mug

		P.U. HT
1006730P	30 cl x 6	4,90 €



Sucrier

		P.U. HT
1006737P	15 cl x 12	5,40 €



Saucière

		P.U. HT
1006734P	25 cl x 6	8,10 €



Plat mezza

		P.U. HT
1006723P	Ø 17 cm x 6	9,50 €
1006724P	Ø 13 cm x 12	6,90 €



Tasse à espresso

		P.U. HT
1006701P	9 cl x 12	2,90 €

Tasse à thé

		P.U. HT
1006704P	23 cl x 12	4,30 €
1006703	20 cl x 12	4,20 €

Tasse à déjeuner

		P.U. HT
1006708	30 cl x 6	5,10 €



Théière empilable avec couvercle

		P.U. HT
1006738P	40 cl x 2	11,00 €

Couvercle seul pour théière

		P.U. HT
1006739	x 12	3,30 €



Ramequin lisse

		P.U. HT
1006731P	18 cl x 6	4,60 €
1006732P	12 cl x 12	3,10 €
1006733P	6 cl x 12	2,70 €



Coquetier

		P.U. HT
1006727P	Ø 6,5 x H. 5 cm x 12	3,50 €

BRASSERIE



ART DE LA TABLE

SURFACE  
*FvR*  
SERAX



A COLLECTION BY  
SERGIO HERMAN



Avec sa collection étendue de vaisselle, Serax s'est affirmé en quelques années comme innovateur dans le secteur des arts de la table. Formes originales et choix des matériaux sont à l'unisson pour créer des collections uniques et diversifiées. Les créations de concepteurs belges et étrangers ont suscité l'admiration des chefs étoilés renommés dans le monde entier.

**SERAX**





# SURFACE

SURFACE

nouveau !

## Surface

En grès.



Camogreen



Assiette plate

<b>1013012</b>	∅ 27 cm	x 4	<b>16,50 €</b>
<b>1013010</b>	∅ 24 cm	x 4	<b>13,90 €</b>
<b>1013008</b>	∅ 21 cm	x 4	<b>12,90 €</b>
<b>1013006</b>	∅ 16 cm	x 4	<b>9,20 €</b>

Indi grey



Assiette plate

<b>1013013</b>	∅ 27 cm	x 4	<b>16,50 €</b>
<b>1013011</b>	∅ 24 cm	x 4	<b>13,90 €</b>
<b>1013009</b>	∅ 21 cm	x 4	<b>12,90 €</b>
<b>1013007</b>	∅ 16 cm	x 4	<b>9,20 €</b>



Assiette creuse

<b>1013016</b>	∅ 21 x H. 4 cm	x 4	<b>14,30 €</b>
<b>1013014</b>	∅ 16 x H. 4 cm	x 4	<b>11,20 €</b>



Assiette plate

<b>1013017</b>	∅ 21 x H. 4 cm	x 4	<b>14,30 €</b>
<b>1013015</b>	∅ 16 x H. 4 cm	x 4	<b>11,20 €</b>



Assiette ovale

<b>1013020</b>	L. 25 x l. 15 cm	x 4	<b>13,30 €</b>
----------------	------------------	-----	----------------



Assiette ovale

<b>1013021</b>	L. 25 x l. 15 cm	x 4	<b>13,30 €</b>
----------------	------------------	-----	----------------



Coupelle

<b>1013022</b>	∅ 9 x H. 2 cm	x 4	<b>4,00 €</b>
<b>1013018</b>	∅ 13 x H. 5 cm	x 4	<b>10,20 €</b>



Coupelle

<b>1013023</b>	∅ 9 x H. 2 cm	x 4	<b>4,00 €</b>
<b>1013019</b>	∅ 13 x H. 5 cm	x 4	<b>10,20 €</b>



ART DE LA TABLE



## Sky

Sky c'est un style brut et authentique, des finitions irrégulières d'une pièce à l'autre.  
Une gamme en grès réactif qui évoque un retour aux sources.  
Les formes très épurées en font une série contemporaine.



pro.mundi



# SKY

SKY



**nouveau !**

## Sky

En grès réactif émaillé.



Assiette coupe plate Ø 28 cm		📦	P.U.HT
<b>1013191P</b>	Gris	x 2	<b>9,60 €</b>
<b>1013196P</b>	Bleu	x 2	<b>9,60 €</b>
<b>1013200P</b>	Vert	x 2	<b>9,60 €</b>
Assiette coupe plate Ø 24 cm		📦	P.U.HT
<b>1013192P</b>	Gris	x 6	<b>8,60 €</b>
<b>1013197P</b>	Bleu	x 6	<b>8,60 €</b>
<b>1013201P</b>	Vert	x 6	<b>8,60 €</b>
Assiette coupe plate Ø 20 cm		📦	P.U.HT
<b>1013193P</b>	Gris	x 4	<b>6,60 €</b>
<b>1013198P</b>	Bleu	x 4	<b>6,60 €</b>
<b>1013202P</b>	Vert	x 4	<b>6,60 €</b>

Assiette coupe creuse Ø 22 cm		📦	P.U.HT
<b>1013194P</b>	Gris	x 4	<b>8,60 €</b>
<b>1013199P</b>	Bleu	x 4	<b>8,60 €</b>
<b>1013203P</b>	Vert	x 4	<b>8,60 €</b>

Coupelle Ø 14 x H. 4,5 cm		📦	P.U.HT
<b>1013195P</b>	Gris	x 6	<b>5,00 €</b>
<b>1013205P</b>	Bleu	x 6	<b>5,00 €</b>
<b>1013204P</b>	Vert	x 6	<b>5,00 €</b>

ART DE LA TABLE

# WINTER

## Winter

En grès émaillé craquelé.

### Assiette plate



Jaune  
**1006655P** Ø 25,5 cm x 3 **P.U.HT 11,10 €**  
**1006652P** Ø 22 cm x 4 **8,20 €**



Gris  
**1006653P** Ø 25,5 cm x 3 **P.U.HT 11,10 €**  
**1006651P** Ø 22 cm x 4 **8,20 €**

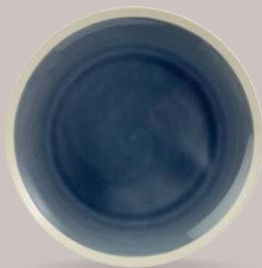

Bleu  
**1006654P** Ø 25,5 cm x 3 **P.U.HT 11,10 €**  
**1006650P** Ø 22 cm x 4 **8,20 €**

### Assiette coupe et plat ovale



Jaune  
**1007046P** Ø 24 cm x 4 **P.U.HT 13,00 €**



Jaune  
**1006667P** L. 30,5 x l. 13 cm x 4 **P.U.HT 11,50 €**  
**1006664P** L. 25 x l. 11,5 cm x 6 **9,50 €**



Gris  
**1006666P** L. 30,5 x l. 13 cm x 4 **P.U.HT 11,50 €**  
**1006663P** L. 25 x l. 11,5 cm x 6 **9,50 €**



Bleu  
**1007047P** Ø 24 cm x 4 **P.U.HT 13,00 €**

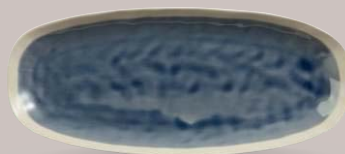

Bleu  
**1006665P** L. 30,5 x l. 13 cm x 4 **P.U.HT 11,50 €**  
**1006662P** L. 25 x l. 11,5 cm x 6 **9,50 €**

### Saladier et coupelle

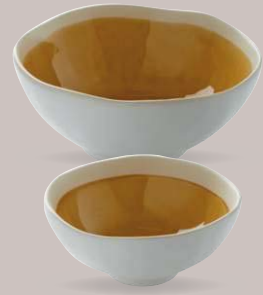

Jaune  
**1006661P** Ø 17,5 x H. 7,5 cm - 75 cl x 4 **P.U.HT 10,50 €**  
**1006658P** Ø 12,5 x H. 5,5 cm - 25 cl x 6 **4,20 €**



Gris  
**1006660P** Ø 17,5 x H. 7,5 cm - 75 cl x 4 **P.U.HT 10,50 €**  
**1006657P** Ø 12,5 x H. 5,5 cm - 25 cl x 6 **4,20 €**



Bleu  
**1006659P** Ø 17,5 x H. 7,5 cm - 75 cl x 4 **P.U.HT 10,50 €**  
**1006656P** Ø 12,5 x H. 5,5 cm - 25 cl x 6 **4,20 €**





ARTIC



pro.mundi

LINEN

ARTIC / LINEN

## Artic

En porcelaine New Bone.



Assiette plate

1009575P Ø 28 cm



P.U.HT

9,80 €



Assiette plate

1009576P Ø 25 cm



P.U.HT

8,80 €



Assiette plate

1009577P Ø 19 cm



P.U.HT

5,10 €



Assiette plate

1009578P Ø 15 cm



P.U.HT

3,40 €

## Linén

En grès émaillé.

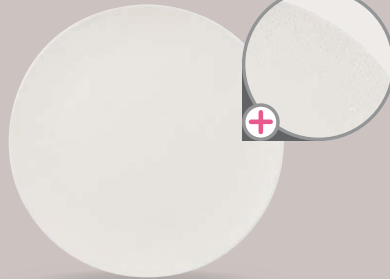

Assiette coupe Blanc

1011095P Ø 28 cm  
1011098P Ø 25,5 cm  
1011101P Ø 20 cm



P.U.HT

11,00 €

10,00 €

7,60 €

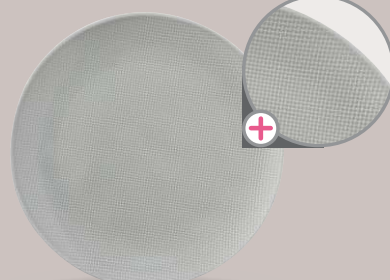

Assiette coupe Gris

1011096P Ø 28 cm  
1011099P Ø 25,5 cm  
1011102P Ø 20 cm



P.U.HT

11,00 €

10,00 €

7,60 €

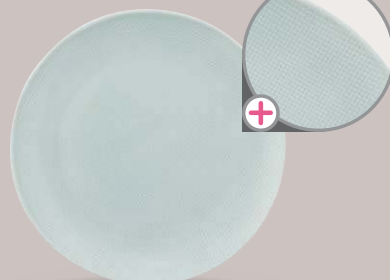

Assiette coupe Céladon

1011097P Ø 28 cm  
1011100P Ø 25,5 cm  
1011103P Ø 20 cm



P.U.HT

11,00 €

10,00 €

7,60 €



Assiette coupe creuse Blanc

1011107P Ø 23,5 cm



P.U.HT

11,00 €



Coupelle Blanc

1011104P Ø 13,5 cm



P.U.HT

5,20 €

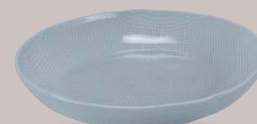

Assiette coupe creuse Gris

1011108P Ø 23,5 cm



P.U.HT

11,00 €



Coupelle Gris

1011105P Ø 13,5 cm



P.U.HT

5,20 €



Assiette coupe creuse Céladon

1011109P Ø 23,5 cm



P.U.HT

11,00 €



Coupelle Céladon

1011106P Ø 13,5 cm



P.U.HT

5,20 €



ART DE LA TABLE



# CHIC & MAT

## Chic & Mat

En grès émaillé.



**Assiette plate grande aile**  **P.U.HT**  
**1007041P** Ø 30,5 cm x 3 **13,30 €**  
**1007038P** Ø 28 cm x 3 **11,00 €**



**Assiette gourmet**  **P.U.HT**  
**1007035P** Ø 27 cm x 3 **11,40 €**  
**1007037P** Ø 21 cm x 4 **8,50 €**



**Assiette bombée**  **P.U.HT**  
**1007043P** Ø 29 cm x 2 **13,40 €**  
**1007045P** Ø 23 cm x 4 **9,10 €**



**Assiette plate grande aile**  **P.U.HT**  
**1007040P** Ø 30,5 cm x 3 **13,30 €**  
**1007039P** Ø 28 cm x 3 **11,00 €**



**Assiette gourmet**  **P.U.HT**  
**1007034P** Ø 27 cm x 3 **11,40 €**  
**1007036P** Ø 21 cm x 4 **8,50 €**



**Assiette bombée**  **P.U.HT**  
**1007042P** Ø 29 cm x 2 **13,40 €**  
**1007044P** Ø 23 cm x 4 **9,10 €**





# BISTROT

BISTROT

## Bistrot

Une gamme en grès émaillé blanc, rouge ou gris avec un filet couleur.



Assiette coupe Ø 25,5 cm			P.U. HT
<b>1010456P</b>	Blanc filet gris	x 4	<b>10,00 €</b>
<b>1010455P</b>	Blanc filet noir	x 4	<b>10,00 €</b>
<b>1010457P</b>	Blanc filet rouge	x 4	<b>10,00 €</b>



Bol Ø 16 cm			P.U. HT
<b>1010464P</b>	Gris filet noir	x 4	<b>8,40 €</b>
<b>1010466P</b>	Blanc filet noir	x 4	<b>8,40 €</b>
<b>1010465P</b>	Rouge filet noir	x 4	<b>8,40 €</b>



Tasse à expresso 6 cl			P.U. HT
<b>1010459P</b>	Gris filet noir	x 6	<b>2,90 €</b>
<b>1010461P</b>	Blanc filet noir	x 6	<b>2,90 €</b>
<b>1010460P</b>	Rouge filet noir	x 6	<b>2,90 €</b>



Assiette coupe Ø 20,5 cm			P.U. HT
<b>1010453P</b>	Blanc filet gris	x 6	<b>6,50 €</b>
<b>1010452P</b>	Blanc filet noir	x 6	<b>6,50 €</b>
<b>1010454P</b>	Blanc filet rouge	x 6	<b>6,50 €</b>



Sous-tasse à expresso Ø 11 cm			P.U. HT
<b>1010458P</b>	Blanc filet noir	x 6	<b>2,80 €</b>



Mug 25 cl			P.U. HT
<b>1010467P</b>	Gris filet noir	x 6	<b>3,90 €</b>
<b>1010463P</b>	Blanc filet noir	x 6	<b>3,90 €</b>
<b>1010462P</b>	Rouge filet noir	x 6	<b>3,90 €</b>



# Grès couleur

En grès émaillé.



Assiette à steak

L. 34,5 x l. 23,5 cm

1010315P Rouge

1010317P Bleu



x 6

P.U.HT

10,10 €

x 6

10,10 €

L. 29 x l. 19,5 cm

1005512P Rouge

1005511P Bleu



x 6

P.U.HT

9,10 €

x 6

9,10 €



Assiette burger L. 29 x l. 14 cm

1005510P Rouge

1005509P Bleu



x 6

P.U.HT

8,20 €

x 6

8,20 €



Assiette à pizza

1010316P Ø 33 cm



x 6

P.U.HT

10,40 €



Pot à sauce Ø 5 x H. 4,5 cm - 5 cl

1005514P Rouge

1005513P Bleu



x 12

P.U.HT

2,60 €

x 12

2,60 €



Assiette plate

Beige

58701P

Ø 27 cm



x 12

P.U.HT

6,70 €

58703P

Ø 24 cm

x 12

6,10 €

58704P

Ø 19 cm

x 12

4,10 €



Rouge

63398P

Ø 27 cm



x 12

P.U.HT

6,70 €

63402P

Ø 24 cm

x 12

6,10 €



Bleu nuit

1007020P

Ø 27 cm



x 12

P.U.HT

6,70 €

1007022P

Ø 24 cm

x 12

6,10 €



Assiette creuse

63400P

Ø 21 cm



x 12

P.U.HT

6,10 €



Assiette coupe creuse Ø 23 cm

1007018P

Beige



x 6

P.U.HT

8,20 €

1007019P

Rouge

x 6

8,20 €

1007021P

Bleu nuit

x 6

8,20 €



Pot à beurre Ø 7 x H. 3,5 cm

1007023P

Beige



x 12

P.U.HT

3,00 €

1007024P

Rouge

x 12

3,00 €

1007025P

Bleu nuit

x 12

3,00 €







# SAPHIR

SAPHIR



**nouveau !**

## Saphir

En grès réactif émaillé.



Assiette coupe plate  
**1013221P** Ø 27,5 cm



 **P.U.HT**  
x 3 **10,60 €**



Assiette coupe creuse  
**1013223P** Ø 21,5 x H. 6 cm



 **P.U.HT**  
x 2 **10,60 €**



Assiette coupe plate  
**1013222P** Ø 20,5 cm



 **P.U.HT**  
x 4 **7,00 €**

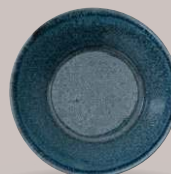

Coupelle  
**1013224P** Ø 15 x H. 6 cm



 **P.U.HT**  
x 2 **7,60 €**

ART DE LA TABLE

# RIM

## Rim

En porcelaine New Bone.



Assiette coupe Vanille

**1011047P** Ø 27 cm  
**1011052P** Ø 24 cm  
**1011056P** Ø 21 cm



x 3  
 x 4  
 x 6

**P.U.HT**  
**8,80 €**  
**7,80 €**  
**6,10 €**



Assiette coupe Taupe

**1011051P** Ø 27 cm  
**1011055P** Ø 24 cm  
**1011059P** Ø 21 cm



x 3  
 x 4  
 x 6

**P.U.HT**  
**8,80 €**  
**7,80 €**  
**6,10 €**



Assiette coupe creuse Vanille

**1011060P** Ø 21 cm



x 4

**P.U.HT**  
**7,80 €**



Assiette coupe creuse Taupe

**1011063P** Ø 21 cm



x 4

**P.U.HT**  
**7,80 €**



Assiette coupe Vert d'eau

**1011050P** Ø 27 cm  
**1011054P** Ø 24 cm  
**1011058P** Ø 21 cm



x 3  
 x 4  
 x 6

**P.U.HT**  
**8,80 €**  
**7,80 €**  
**6,10 €**



Assiette coupe Terracotta

**1011048P** Ø 27 cm  
**1011053P** Ø 24 cm  
**1011057P** Ø 21 cm



x 3  
 x 4  
 x 6

**P.U.HT**  
**8,80 €**  
**7,80 €**  
**6,10 €**



Assiette coupe creuse Vert d'eau

**1011062P** Ø 21 cm



x 4

**P.U.HT**  
**7,80 €**



Assiette coupe creuse Terracotta

**1011061P** Ø 21 cm



x 4

**P.U.HT**  
**7,80 €**





# OKITO

TWINS

## Okito

En porcelaine renforcée ultra-blanche.

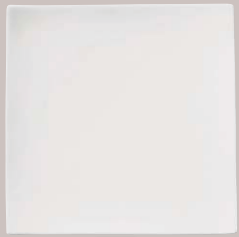

Assiette carrée			P.U.HT
<b>1001738P</b>	L. 27 x l. 27 cm	x 4	<b>11,40 €</b>
<b>1001737P</b>	L. 24 x l. 24 cm	x 4	<b>8,80 €</b>
<b>1001736P</b>	L. 21 x l. 21 cm	x 6	<b>6,20 €</b>



Assiette carrée relief			P.U.HT
<b>1013040P</b>	L. 29 x l. 29 cm	x 2	<b>13,00 €</b>
<b>1009579P</b>	L. 19 x l. 19 cm	x 6	<b>5,00 €</b>



Assiette rectangle			P.U.HT
<b>1009581P</b>	L. 32 x l. 24 cm	x 3	<b>10,00 €</b>
<b>1009582P</b>	L. 29 x l. 22 cm	x 3	<b>8,00 €</b>

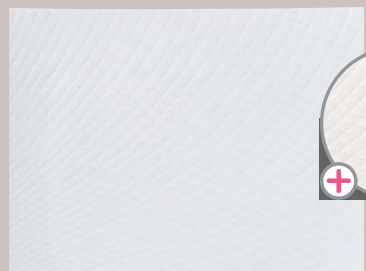

Assiette rectangle relief			P.U.HT
<b>1013039P</b>	L. 32 x l. 24 cm	x 2	<b>11,00 €</b>
<b>1009580P</b>	L. 22 x l. 17 cm	x 6	<b>6,00 €</b>

## Twins

En porcelaine renforcée ultra-blanche.



Assiette carrée			P.U.HT
<b>68166P</b>	L. 31 x l. 31 cm	x 3	<b>12,50 €</b>
<b>68167P</b>	L. 26,5 x l. 26,5 cm	x 6	<b>9,50 €</b>
<b>68168P</b>	L. 16 x l. 16 cm	x 6	<b>4,00 €</b>



Assiette rectangle			P.U.HT
<b>68169P</b>	L. 32 x l. 23 cm	x 3	<b>10,80 €</b>
<b>68170P</b>	L. 21 x l. 15 cm	x 6	<b>5,80 €</b>



Coupelle carrée			P.U.HT
<b>68171P</b>	L. 12,6 x l. 12,6 cm H. 5,8 cm - 30 cl	x 6	<b>5,60 €</b>



Tasse à café			P.U.HT
<b>69489P</b>	8 cl	x 12	<b>2,90 €</b>
Sous-tasse à café carrée			P.U.HT
<b>69490P</b>	L. 10,5 x l. 10,5 cm	x 12	<b>2,90 €</b>

OKITO / TWINS



ART DE LA TABLE



# EDINA

## Edina

En porcelaine blanche.



Assiette creuse carrée  
 58776P L. 20 x l. 20 cm

x 12

P.U.HT  
 8,00 €

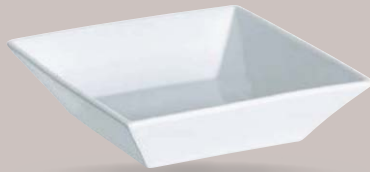

Ravier carré  
 58201P L. 9,3 x l. 9,3 x H. 4 cm

x 12

P.U.HT  
 1,90 €



### Assiette plate

Code	Dimensions	Quantité	P.U.HT
58583P	L. 30 x l. 30 cm	x 3	9,00 €
58775P	E L. 27 x l. 27 cm	x 6	7,90 €
58165P	E L. 25 x l. 25 cm	x 6	6,50 €
58164P	E L. 21 x l. 21 cm	x 12	4,20 €
58163P	E L. 16 x l. 16 cm	x 12	2,80 €
58585P	E L. 13 x l. 13 cm	x 12	1,90 €



Sous-tasse à café / thé gourmand  
 1002179P L. 21 x l. 13 cm

x 12

P.U.HT  
 4,30 €



Ravier rectangle  
 58586P E L. 13 x l. 9,3 cm x H. 4 cm

x 12

P.U.HT  
 2,30 €



### Assiette plate rectangulaire

Code	Dimensions	Quantité	P.U.HT
69374P	L. 39 x l. 25,5 cm	x 4	14,00 €
58777P	E L. 33 x l. 18 cm	x 3	6,90 €
69373P	E L. 28 x l. 18,5 cm	x 6	6,20 €
58584P	L. 21 x l. 13 cm	x 12	3,10 €

Ravier  
 58780P E L. 14 x l. 14 x H. 3 cm  
 58781P L. 11 x l. 11 x H. 2,3 cm  
 58784P L. 9 x l. 9 x H. 2 cm

x 12  
 x 12  
 x 12

P.U.HT  
 4,40 €  
 2,20 €  
 1,50 €

### Saladier / Coupelle

Code	Dimensions	Quantité	P.U.HT
58778P	L. 20 x l. 20 cm x H. 7 cm	x 6	8,60 €
58199P	L. 15 x l. 15 x H. 7 cm	x 6	5,50 €
58782P	L. 12 x l. 12 x H. 4,5 cm	x 12	3,00 €
58783P	L. 9 x l. 9 cm x H. 4 cm	x 12	1,90 €





# FOLIA

## Folia

En porcelaine renforcée ultra-blanche.



🛒 <b>68111P</b>	L. 36,5 x l. 21 cm	x 6	<b>P.U. HT</b>
<b>68112P</b>	L. 31 x l. 18 cm	x 6	<b>15,50 €</b>
<b>68113P</b>	E. L. 19 x l. 11 cm	x 6	<b>9,00 €</b>
			<b>3,30 €</b>

## Bamboo

En porcelaine renforcée ultra-blanche.

Bamboo en verre,  
voir page 92



<b>68108P</b>	L. 38 x l. 10 cm	x 3	<b>P.U. HT</b>
<b>68109P</b>	L. 31 x l. 8 cm	x 6	<b>10,50 €</b>
<b>68110P</b>	L. 26 x l. 7 cm	x 6	<b>7,80 €</b>
			<b>5,20 €</b>

## Tutti

En porcelaine blanche.



<b>Saladier</b>			<b>P.U. HT</b>
🛒 <b>69353P</b>	Ø 25 x H. 10,5 cm - 135 cl	x 6	<b>17,00 €</b>
🛒 <b>68119P</b>	Ø 21 x H. 9 cm - 55 cl	x 6	<b>13,20 €</b>
🛒 <b>68122P</b>	Ø 18 x H. 8 cm - 35 cl	x 6	<b>10,70 €</b>

<b>Coupelle</b>			<b>P.U. HT</b>
<b>68115P</b>	Ø 14 x H. 6 cm - 17 cl	x 12	<b>6,80 €</b>
<b>68114P</b>	Ø 10 x H. 4,5 cm - 7 cl	x 12	<b>4,00 €</b>



# MATCHA

## Matcha

En porcelaine renforcée ultra-blanche.



<b>Assiette plate</b>			<b>P.U. HT</b>
<b>68214P</b>	L. 37 x l. 21 cm	x 3	<b>13,30 €</b>
<b>68213P</b>	L. 31 x l. 18 cm	x 6	<b>8,80 €</b>
<b>68212P</b>	L. 22 x l. 12 cm	x 6	<b>4,40 €</b>



<b>Saladier</b>			<b>P.U. HT</b>
<b>68218P</b>	L. 26 x l. 20 x H. 9 cm - 176 cl	x 6	<b>17,50 €</b>
<b>68217P</b>	L. 22 x l. 17 x H. 7 cm - 72 cl	x 6	<b>10,90 €</b>



<b>Coupelle</b>			<b>P.U. HT</b>
<b>68216P</b>	L. 13,4 x l. 10,5 x H. 5,4 cm - 19 cl	x 12	<b>6,20 €</b>
<b>68215P</b>	L. 11 x l. 8,5 x H. 4,7 cm - 11 cl	x 12	<b>3,20 €</b>



# CÉLESTE

## Céleste

En porcelaine ultra-blanche.



<b>Assiette plate</b>			<b>P.U. HT</b>
<b>1000016P</b>	Ø 27 cm	x 6	<b>10,50 €</b>
<b>1000015P</b>	Ø 22 cm	x 6	<b>7,80 €</b>



<b>Assiette creuse</b>			<b>P.U. HT</b>
<b>1000019P</b>	Ø 26 cm	x 3	<b>15,25 €</b>
<b>1000018P</b>	Ø 23 cm	x 4	<b>10,60 €</b>



<b>Coupelle / bol</b>			<b>P.U. HT</b>
<b>1000021P</b>	Ø 14 cm - 33 cl	x 6	<b>4,90 €</b>



# INTEMPOREL

# ROMA COLOR

## Intemporel

Décor grand feu inaltérable sur porcelaine blanche.

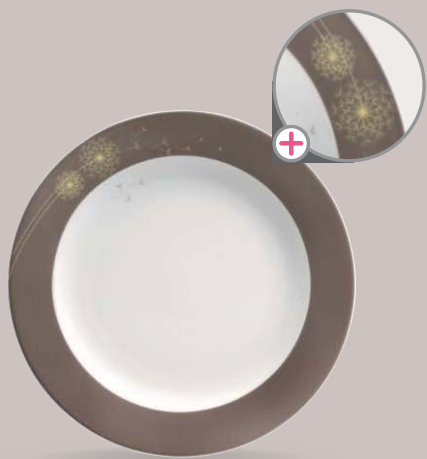

Assiette plate

**66582P** E Ø 26,5 cm  
**66583P** E Ø 24 cm

x 12  
x 12

**P.U.HT**  
**6,20 €**  
**4,80 €**

Assiette creuse

**66586P** E Ø 22,5 cm

x 12

**P.U.HT**  
**4,40 €**



Assiette à pain

**66584P** E Ø 16 cm

x 12

**P.U.HT**  
**3,00 €**



Assiette à dessert

**66585P** E Ø 19 cm

x 12

**P.U.HT**  
**3,00 €**

## Roma color

Décor grand feu sur porcelaine blanche.



Assiette plate rouge

**68422P** E Ø 26 cm  
**68421P** E Ø 21 cm

x 12  
x 12

**P.U.HT**  
**4,60 €**  
**4,40 €**

Assiette plate grise

**68423P** E Ø 26 cm  
**68424P** E Ø 21 cm

x 12  
x 12

**P.U.HT**  
**4,60 €**  
**4,40 €**



# BAZIK

BAZIK

**nouveau !**

## Bazik

En grès émaillé noir mat.



### Assiette rectangle

			P.U. HT
<b>1013228P</b>	L. 30 x l. 20 cm	x 6	<b>6,00 €</b>
<b>1013229P</b>	L. 25 x l. 15 cm	x 6	<b>3,80 €</b>
<b>1013230P</b>	L. 20 x l. 13 cm	x 12	<b>3,30 €</b>



### Assiette carrée

			P.U. HT
<b>1013225P</b>	L. 26 x l. 26 cm	x 6	<b>5,10 €</b>
<b>1013226P</b>	L. 24 x l. 24 cm	x 6	<b>4,70 €</b>
<b>1013227P</b>	L. 21 x l. 21 cm	x 6	<b>4,10 €</b>



### Assiette plate

			P.U. HT
<b>1013231P</b>	Ø 27,5 cm	x 6	<b>4,20 €</b>
<b>1013232P</b>	Ø 25 cm	x 6	<b>3,80 €</b>
<b>1013233P</b>	Ø 21 cm	x 6	<b>2,30 €</b>



### Assiette creuse

			P.U. HT
<b>1013234P</b>	Ø 23 cm	x 6	<b>3,20 €</b>



ART DE LA TABLE



EKTA

CLASSIC SQUARE

CÉLÉBRATION

### Ekta

En porcelaine blanche.



Assiette plate carrée

- 1001581P** L. 20 x l. 28 cm - Bassin 24 cm x 6
- 1001582P** L. 25 x l. 25 cm - Bassin 22 cm x 6



**P.U.HT**  
**7,60 €**  
**6,00 €**



Assiette creuse carrée

- 1001580P** L. 20 x l. 20 cm - Bassin 16 cm x 12
- 1001584P** L. 15 x l. 15 cm - Bassin 12,5 cm x 12



**P.U.HT**  
**3,90 €**  
**3,20 €**



Assiette rectangulaire

- 1001583P** L. 29,5 x l. 19 cm - Bassin 26 x 16 cm



**P.U.HT**  
**7,60 €**

### Classic square

En porcelaine blanche.



Assiette plate carrée

- 56526P** L. 27 x l. 27 cm x 6
- 56527P** L. 21,5 x l. 21,5 cm x 12
- 136971P** L. 13 x l. 13 cm x 12



**P.U.HT**  
**6,90 €**  
**5,30 €**  
**4,80 €**



Assiette creuse carrée

- 56528P** L. 21,5 x l. 21,5 cm



**P.U.HT**  
**6,50 €**



Coupe carrée

- 1001389P** L. 15 x l. 15 x H. 5,5 cm - 48 cl x 12



**P.U.HT**  
**7,10 €**



Assiette plate rectangulaire

- 54288P** L. 33 x l. 18 cm x 6
- 54289P** L. 22 x l. 11 cm x 6



**P.U.HT**  
**12,30 €**  
**9,40 €**

### Célébration

En porcelaine blanche.



Assiette plate carrée

- 68417P** L. 27,5 x l. 27,5 cm - Bassin 17 cm x 6



**P.U.HT**  
**6,40 €**



Assiette plate carrée

- 68415P** L. 23 x l. 23 cm - Bassin 14 cm x 6



**P.U.HT**  
**4,60 €**



Assiette creuse carrée

- 68416P** L. 23 x l. 23 cm - Bassin 15 cm x 6



**P.U.HT**  
**5,00 €**





## Bermudes

En porcelaine blanche.



Assiette plate triangulaire

<b>60100P</b>	29 cm	x 12	<b>P.U.HT</b> <b>4,70 €</b>
<b>60101P</b>	24 cm	x 12	<b>4,10 €</b>
<b>60102P</b>	19 cm	x 12	<b>3,30 €</b>



Assiette creuse triangulaire

<b>60106P</b>	26 cm	x 12	<b>P.U.HT</b> <b>8,30 €</b>
---------------	-------	------	--------------------------------



Assiette creuse triangulaire

<b>60103P</b>	22,5 cm	x 12	<b>P.U.HT</b> <b>4,30 €</b>
---------------	---------	------	--------------------------------

## Wing

En porcelaine blanche.



Assiette plate petite aile

<b>66422P</b>	L. 35 x l. 25 cm	x 6	<b>P.U.HT</b> <b>5,80 €</b>
---------------	------------------	-----	--------------------------------



Assiette plate grande aile

<b>66167P</b>	L. 31 x l. 26 cm	x 6	<b>P.U.HT</b> <b>4,40 €</b>
---------------	------------------	-----	--------------------------------



Assiette plate grande aile

<b>66168P</b>	L. 25 x l. 22 cm	x 6	<b>P.U.HT</b> <b>4,20 €</b>
---------------	------------------	-----	--------------------------------



# ROMA



# RUBY

PORCELAINES BLANCHES

## Roma

En porcelaine blanche ultra-légère.



Assiette plate

<b>63037P</b>	∅ 30,5 cm	x 12
<b>61654P</b>	E ∅ 26 cm	x 12
<b>61655P</b>	E ∅ 21 cm	x 12

P.U.HT

<b>6,00 €</b>
<b>2,70 €</b>
<b>2,40 €</b>

Assiette creuse

<b>70547P</b>	∅ 27 cm	x 6
<b>61656P</b>	E ∅ 22,5 cm	x 12

P.U.HT

<b>7,00 €</b>
<b>2,70 €</b>

## Ruby

En porcelaine blanche très résistante.



Assiette plate

<b>1001585P</b>	∅ 30 cm	x 6
<b>1001586P</b>	∅ 27 cm	x 12
<b>1001587P</b>	E ∅ 24 cm	x 12
<b>1001588P</b>	E ∅ 22 cm	x 12
<b>1001589P</b>	E ∅ 18 cm	x 12
<b>1001590P</b>	E ∅ 16 cm	x 12

P.U.HT

<b>5,40 €</b>
<b>3,20 €</b>
<b>2,10 €</b>
<b>2,00 €</b>
<b>1,90 €</b>
<b>1,70 €</b>

Assiette creuse

<b>1001592P</b>	∅ 30 cm	x 6
<b>1001591P</b>	E ∅ 23 cm	x 12

P.U.HT

<b>5,40 €</b>
<b>2,30 €</b>



Tasse à café

<b>61657P</b>	E 10 cl
---------------	---------

∅

x 24

P.U.HT

**1,80 €**

Sous-tasse à café

<b>61658P</b>	E ∅ 14 cm
---------------	-----------

∅

x 24

P.U.HT

**1,10 €**



Tasse à café empilable

<b>1001593P</b>	E 9 cl	x 12
-----------------	--------	------

P.U.HT

**1,10 €**

Tasse à thé empilable

<b>1001595P</b>	E 17 cl	x 12
-----------------	---------	------

P.U.HT

**1,70 €**

Tasse à déjeuner empilable

<b>1001596P</b>	E 23 cl	x 12
-----------------	---------	------

P.U.HT

**2,00 €**

Sous-tasse à thé/déjeuner

<b>1001597P</b>	E ∅ 17 cm	x 12
-----------------	-----------	------

P.U.HT

**1,10 €**

## Roma filet or

En porcelaine blanche avec un filet or.



Assiette plate

<b>52332P</b>	∅ 26 cm
<b>52333P</b>	∅ 21 cm

∅

x 12

P.U.HT

**4,90 €**

Tasse à café

<b>52334</b>	10 cl
--------------	-------

∅

x 36

P.U.HT

**2,50 €**

Sous-tasse café

<b>52335</b>	∅ 11 cm
--------------	---------

∅

x 12

P.U.HT

**1,20 €**

## K

En porcelaine blanche.



Assiette plate

<b>56608P</b>	∅ 30,5 cm	x 12
<b>56607P</b>	∅ 26 cm	x 12
<b>56606P</b>	∅ 24 cm	x 12
<b>56605P</b>	∅ 22,5 cm	x 12
<b>56604P</b>	∅ 21 cm	x 12
<b>56603P</b>	∅ 19 cm	x 12
<b>56594P</b>	∅ 17 cm	x 12
<b>56602P</b>	∅ 16 cm	x 12
<b>56601P</b>	∅ 14 cm	x 12

P.U.HT

<b>6,40 €</b>
<b>4,10 €</b>
<b>3,70 €</b>
<b>3,20 €</b>
<b>2,60 €</b>
<b>2,40 €</b>
<b>2,10 €</b>
<b>1,90 €</b>
<b>1,60 €</b>

Assiette creuse

<b>44607P</b>	∅ 22,5 cm	x 12
---------------	-----------	------

P.U.HT

**3,10 €**



Bol Amerika

<b>44611P</b>	∅ 14 cm	x 12
	50 cl	

P.U.HT

**2,80 €**



HÔTEL



VÉNUS

## Hôtel

En porcelaine blanche.



### Assiette coupe plate

	E	∅	x	P.U. HT
50153P	28	cm	x 6	4,40 €
50154P	25	cm	x 12	2,60 €
50155P	21	cm	x 12	2,20 €
50156P	17	cm	x 12	1,90 €

## Vénus

En porcelaine blanche.



### Assiette plate

	E	∅	x	P.U. HT
50173P	26	cm	x 12	2,80 €
50174P	24	cm	x 12	2,20 €
50175P	20	cm	x 12	2,20 €
50176P	18	cm	x 12	2,00 €
50177P	15	cm	x 12	1,50 €



Assiette coupe creuse  
50157P E ∅ 20 cm x 12

P.U. HT  
2,40 €



### Ravier rectangle

	E	L	x	l	x	P.U. HT
50163P	17	13	cm	x 12		5,20 €
50162P	14	10,5	cm	x 12		4,20 €



Assiette creuse  
50178P E ∅ 22 cm

P.U. HT  
2,60 €

## Bazik

En porcelaine blanche.



Assiette plate  
1002204P E ∅ 26,5 cm x 24  
1002205P E ∅ 24 cm x 24  
1002206P E ∅ 19 cm x 24

P.U. HT  
1,60 €  
1,30 €  
1,10 €



Assiette creuse  
1002207P E ∅ 20 cm x 24

P.U. HT  
1,30 €



Saladier ovale - 53 cl  
1002232P L 18 x l 13 x H 5,5 cm x 6

P.U. HT  
3,50 €



Saladier carré - 52 cl  
1002174P L 14 x l 14 x H 5 cm x 6

P.U. HT  
3,50 €

## Optima

En porcelaine blanche.



Assiette plate  
69388P E ∅ 24,5 cm x 12  
69389P E ∅ 22 cm x 12  
69390P E ∅ 19 cm x 12

P.U. HT  
3,00 €  
2,40 €  
2,10 €



Assiette creuse  
69391P E ∅ 22 cm x 12  
69392P E ∅ 15 cm x 12  
69393P E ∅ 13 cm x 12

P.U. HT  
2,50 €  
1,30 €  
1,20 €





## Tendency

En Zénix.



Assiette plate

<b>67231</b>	Ø 31,5 cm	x 6	<b>P.U.HT</b>
<b>67229P</b>	Ø 27 cm	x 6	<b>7,30 €</b>
<b>67235P</b>	Ø 22 cm	x 6	<b>3,90 €</b>



Cupelle

<b>67234P</b>	Ø 16 cm - 28 cl	x 6	<b>P.U.HT</b>
			<b>3,40 €</b>



Assiette creuse

<b>67232</b>	Ø 23 cm	x 24	<b>P.U.HT</b>
			<b>3,70 €</b>



Assiette à pâtes

<b>68744P</b>	Ø 28 cm	x 6	<b>P.U.HT</b>
			<b>6,20 €</b>

Pour que nos clients n'aient plus à choisir entre beauté et durabilité, le Centre de Recherche d'Arc International a mis au point ZENIX, une nouvelle matière minérale aux propriétés exceptionnelles.

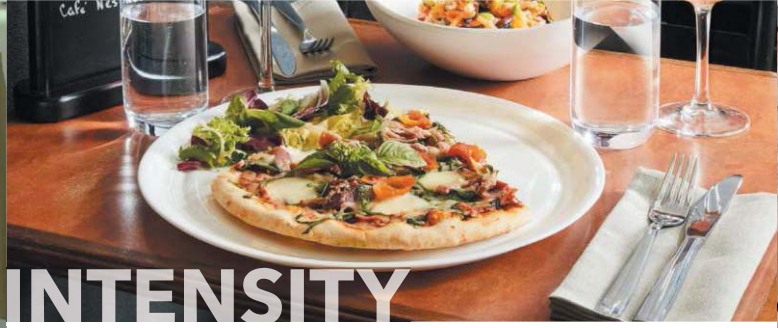

## INTENSITY

### Intensity Zen

En Zénix.



Assiette wok

<b>1011524P</b>	L. 28,5 x H. 6,8 cm - 1,3 L	x 6	<b>P.U.HT</b>
			<b>3,30 €</b>



Assiette à pizza

<b>70466P</b>	Ø 32 cm	x 6	<b>P.U.HT</b>
			<b>4,50 €</b>



Assiette à steak

<b>68741</b>	L. 30 x l. 26 cm	x 12	<b>P.U.HT</b>
			<b>5,80 €</b>



Assiette à risotto

<b>68740P</b>	Ø 29 cm	x 6	<b>P.U.HT</b>
			<b>6,10 €</b>





MEKKANO

## Mekcano

En porcelaine et verre.



Assiette rectangle  
**1011496P** L. 31,5 x l. 16,3 x H. 2,3 cm x 24 **P.U.HT 5,50 €**



Ravier rectangle  
**1011495** L. 14,9 x l. 7 x H. 4,3 cm - 28 cl x 24



Ravier rectangle  
**1011493** L. 14,9 x l. 7 x H. 2,3 cm - 9,5 cl x 24 **P.U.HT 2,10 €**



Ravier carré  
**1011491** L. 7,3 x l. 7,3 x H. 4,3 cm - 13 cl x 24



Ravier carré  
**1011490** L. 7,3 x l. 7,3 x H. 2,3 cm - 4,5 cl x 24 **P.U.HT 1,80 €**

nouveau !



Ravier carré  
**1013212** L. 14,7 x l. 14,7 x H. 4,3 cm - 58 cl x 24 **P.U.HT 3,40 €**



Ravier carré  
**1011492** L. 7,3 x l. 7,3 x H. 6,3 cm - 21 cl x 24 **P.U.HT 2,30 €**

nouveau !

En porcelaine.



Coupe  
**1013208** Ø 11,5 x H. 4,73 cm - 37 cl x 24 **P.U.HT 3,50 €**  
**1013207** Ø 10,9 x H. 4,4 cm - 28 cl x 24 **P.U.HT 3,00 €**



Pot  
**1013210** Ø 6,5 x H. 8,5 cm - 20 cl x 24 **P.U.HT 2,80 €**  
**1013209** Ø 5,6 x H. 7,2 cm - 12 cl x 24 **P.U.HT 2,10 €**

MEKKANO / BE BOP



ART DE LA TABLE



# VELOUTÉE

## Veloutée

En verre trempé.

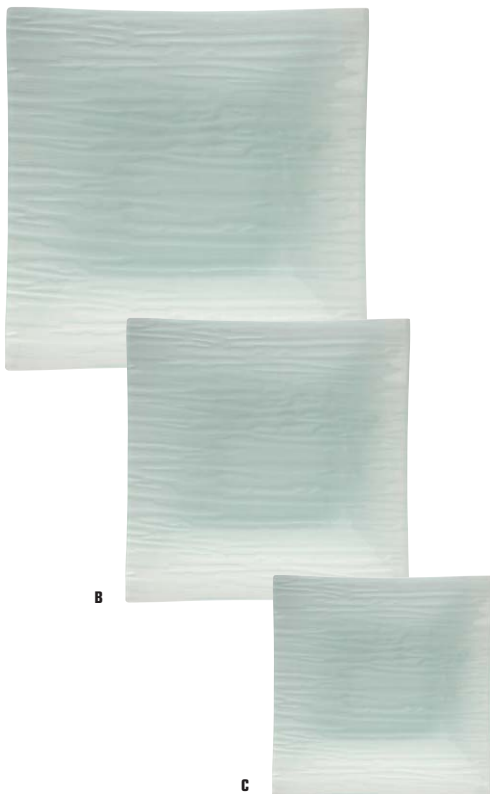

A	<b>67713P</b>	L 26 x l 26 cm	x6	<b>P.U. HT</b>	
B	<b>67712P</b>	L 19,5 x l 19,5 cm	x6	<b>7,10 €</b>	
C	<b>67711P</b>	L 12,8 x l 12,8 cm	x6	<b>5,00 €</b>	
				<b>3,00 €</b>	



# BAMBOO

## Bamboo

En verre thermoformé.



Bamboo porcelaine,  
voir page 83

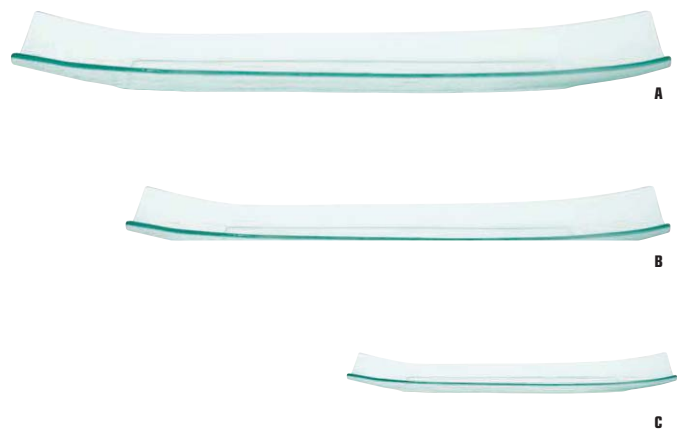

A	<b>67718P</b>	L 38 x l 10 cm	x6	<b>P.U. HT</b>	
B	<b>67717P</b>	L 31 x l 7,5 cm	x6	<b>6,50 €</b>	
C	<b>67716P</b>	L 15,5 x l 6 cm	x6	<b>3,90 €</b>	
				<b>1,70 €</b>	





# DIAMOND

## Diamond

En verre.

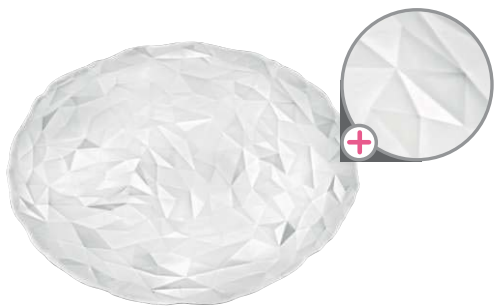

Assiette ovale  
**1011400P** L. 35 x l. 26 cm x 12 **P.U.HT**  
**4,60 €**



Assiette ronde  
**1005343P** Ø 33 cm x 6 **P.U.HT**  
**4,60 €**

## Louison

En verre trempé.

**Luminarc** EXTRA RESISTANT



**1011487** Ø 27 cm x 12 **P.U.HT**  
**1,60 €**  
**1011486** Ø 25 cm x 12 **P.U.HT**  
**1,40 €**  
**1011485** Ø 19 cm x 12 **P.U.HT**  
**1,30 €**



# ARDOISE

## Ardoise

En ardoise naturelle.



Assiette carrée - Lot de 2  
**1002096P** L. 30 x l. 30 cm x 1 **P.U.HT**  
**31,00 €**



Assiette rectangle - Lot de 2  
**1002095P** L. 40 x l. 30 cm x 1 **P.U.HT**  
**29,90 €**  
**1002094P** L. 30 x l. 20 cm x 3 **P.U.HT**  
**19,25 €**  
**1002093P** L. 20 x l. 10 cm x 3 **P.U.HT**  
**14,90 €**



Plateau café gourmand - Lot de 2  
**1002097P** L. 25 x l. 12 cm x 3 **P.U.HT**  
**18,25 €**



Mini ardoise carrée - Lot de 2  
**1002099P** L. 10 x l. 10 cm x 3 **P.U.HT**  
**5,80 €**



# Brush

En opal.

Astucieux : les ailes de couleurs différentes peuvent vous aider à distinguer des aliments spécifiques, ou différencier les régimes...



## Cherry

Code	Description	Quantité	P.U. HT
70457P	E Assiette plate Ø 23,5 cm	x 6	3,40 €
70458P	E Assiette plate Ø 19,5 cm	x 6	2,90 €
70459P	E Assiette plate Ø 15,5 cm	x 6	2,50 €
70460P	E Assiette creuse Ø 22,5 cm	x 6	3,50 €
70467	E Saladier empilable Ø 12 cm - 31,5 cl	x 6	2,20 €
70464P	E Coupelle Ø 12 cm - 11 cl	x 6	2,10 €
70465P	E Ravier L. 11 x l. 11 cm	x 6	4,30 €
70463P	E Bol Ø 13 cm - 51 cl	x 6	2,70 €
70461P	E Tasse à thé empilable 19 cl	x 12	2,40 €
70462P	E Sous-tasse thé Ø 14 cm	x 6	2,20 €



## Blue jean

Code	Description	Quantité	P.U. HT
70447P	E Assiette plate Ø 23,5 cm	x 6	3,40 €
70448P	E Assiette plate Ø 19,5 cm	x 6	2,90 €
70449P	E Assiette plate Ø 15,5 cm	x 6	2,50 €
70450P	E Assiette creuse Ø 22,5 cm	x 6	3,50 €
70455P	E Saladier empilable Ø 12 cm - 31,5 cl	x 6	2,20 €
70456P	E Coupelle Ø 12 cm - 11 cl	x 6	2,10 €
70454P	E Ravier L. 11 x l. 11 cm	x 6	4,30 €
70453P	E Bol Ø 13 cm - 51 cl	x 6	2,70 €
70451P	E Tasse à thé empilable 19 cl	x 12	2,40 €
70452P	E Sous-tasse thé Ø 14 cm	x 6	2,20 €



## Vert

Code	Description	Quantité	P.U. HT
54132P	E Assiette plate Ø 23,5 cm	x 6	3,40 €
54134P	E Assiette plate Ø 19,5 cm	x 6	2,90 €
54133P	E Assiette plate Ø 15,5 cm	x 6	2,50 €
55744P	E Assiette creuse Ø 22,5 cm	x 6	3,50 €
56782	E Saladier empilable Ø 12 cm - 31,5 cl	x 6	2,20 €
54135P	E Coupelle Ø 12 cm - 11 cl	x 6	2,10 €
55745P	E Bol Ø 13 cm - 51 cl	x 6	2,70 €
56766P	E Tasse à thé empilable 19 cl	x 12	2,40 €
56770P	E Sous-tasse thé Ø 14 cm	x 6	2,20 €



## Jaune

Code	Description	Quantité	P.U. HT
54136P	E Assiette plate Ø 23,5 cm	x 6	3,40 €
54138P	E Assiette plate Ø 19,5 cm	x 6	2,90 €
54137P	E Assiette plate Ø 15,5 cm	x 6	2,50 €
55741P	E Assiette creuse Ø 22,5 cm	x 6	3,50 €
56783	E Saladier empilable Ø 12 cm - 31,5 cl	x 6	2,20 €
55740P	E Bol Ø 13 cm - 51 cl	x 6	2,70 €
56767P	E Tasse à thé empilable 19 cl	x 12	2,40 €
56771P	E Sous-tasse thé Ø 14 cm	x 6	2,20 €





## Restaurant

En opal.



Assiette plate

<b>33056P</b>	Ø 25,4 cm	x 6
<b>33057P</b>	E Ø 23,5 cm	x 6
<b>33058P</b>	E Ø 19 cm	x 6
<b>33059P</b>	E Ø 15,5 cm	x 6



Assiette creuse  
Ø 22,5 cm

<b>3337P</b>	E Filet bordeaux	x 6	<b>3,40 €</b>
<b>34316</b>	E Filet bleu	x 6	<b>3,40 €</b>
<b>33060P</b>	E Blanc	x 6	<b>2,70 €</b>



Saladier

<b>43110</b>	E Ø 16 cm	x 24	<b>2,70 €</b>
--------------	-----------	------	---------------



Coupelle

<b>52285</b>	Ø 16 cm	x 36	<b>2,20 €</b>
<b>43111P</b>	E Ø 12 cm	x 36	<b>1,30 €</b>



Assiette plate  
filet bordeaux

<b>3333</b>	Ø 25,4 cm	x 24
<b>3334P</b>	E Ø 23,5 cm	x 6
<b>3335P</b>	E Ø 19 cm	x 6
<b>3336P</b>	E Ø 15,5 cm	x 6



Tasse à moka

<b>37319P</b>	8 cl	x 12	<b>1,10 €</b>
---------------	------	------	---------------

Sous-tasse à moka

<b>37320P</b>	Ø 11,2 cm	x 6	<b>0,81 €</b>
---------------	-----------	-----	---------------

Tasse à café

<b>37321P</b>	E 13 cl	x 12	<b>1,30 €</b>
<b>37323P</b>	E 19 cl	x 12	<b>1,40 €</b>

Sous-tasse à café

<b>37322P</b>	E Ø 13 cm	x 6	<b>0,89 €</b>
<b>37324P</b>	E Ø 14 cm	x 6	<b>1,10 €</b>



Saladier empilable

<b>52281P</b>	Ø 12 cm	x 6	<b>1,60 €</b>
---------------	---------	-----	---------------



Ravier empilable

<b>43112P</b>	E L. 11 x l. 11 cm	x 6	<b>2,40 €</b>
---------------	--------------------	-----	---------------



Bol à bouillon empilable

<b>52279P</b>	E 32 cl	x 6	<b>2,00 €</b>
---------------	---------	-----	---------------



Assiette plate  
filet bleu

<b>34313P</b>	E Ø 23,5 cm	x 6	<b>3,30 €</b>
<b>34314P</b>	E Ø 19 cm	x 6	<b>2,80 €</b>
<b>34315</b>	E Ø 15,5 cm	x 6	<b>2,30 €</b>



Tasse à déjeuner

<b>37325P</b>	E 25 cl	x 6	<b>1,50 €</b>
---------------	---------	-----	---------------

Sous-tasse à déjeuner

<b>37326P</b>	E Ø 15,3 cm	x 6	<b>1,20 €</b>
---------------	-------------	-----	---------------



Ravier empilable  
L. 14 x l. 9 cm

<b>37327P</b>	E Blanc	x 6	<b>2,40 €</b>
---------------	---------	-----	---------------



Bol empilable 51 cl

<b>34302P</b>	E Filet bordeaux	x 6	<b>2,60 €</b>
<b>34320P</b>	E Filet bleu	x 6	<b>2,60 €</b>
<b>33287P</b>	E Blanc	x 6	<b>1,30 €</b>





# STAIRO

## Stairo

ARCOROC

En opal blanc. Assiette ultra légère, 1,5 fois plus légère qu'une porcelaine Hôtelière = manipulation facilitée ; moins de problèmes de tendinites.



Assiette plate

<b>1008042P</b> E Ø 27 cm	x 6	<b>P.U.HT</b>
<b>1008043P</b> E Ø 25 cm	x 6	<b>1,20 €</b>
<b>1008680P</b> E Ø 23,5 cm	x 6	<b>0,92 €</b>
<b>1008044P</b> E Ø 19 cm	x 6	<b>0,81 €</b>
		<b>0,79 €</b>



Assiette creuse

<b>1008045P</b> E Ø 23,6 cm	x 6	<b>P.U.HT</b>
		<b>0,92 €</b>



Bol

<b>1008046P</b> Ø 13,2 cm - 50 cl	x 6	<b>P.U.HT</b>
		<b>1,20 €</b>



# FESTON

## 1<sup>er</sup> PRIX

## Feston

ARCOROC

En opal.



Assiette plate

<b>3330P</b> E Ø 23 cm	x 6	<b>P.U.HT</b>
<b>3331P</b> E Ø 19 cm	x 36	<b>0,97 €</b>
		<b>0,87 €</b>



Assiette creuse

<b>3332P</b> E Ø 21 cm	x 6	<b>P.U.HT</b>
		<b>0,90 €</b>



## Caféterie

ARCOROC

En opal.



Bol

<b>42740P</b> E Ø 13,2 cm - 47 cl	x 6	<b>P.U.HT</b>
		<b>1,40 €</b>



Tasse à thé

<b>1164P</b> 14 cl	x 12	<b>P.U.HT</b>
<b>1001762P</b> Ø 14 cm	x 6	<b>1,30 €</b>

Sous tasse à thé

<b>1166P</b> 28 cl	x 6	<b>1,30 €</b>
--------------------	-----	---------------

Tasse à déjeuner

<b>1167P</b> Ø 16 cm	x 6	<b>1,70 €</b>
----------------------	-----	---------------

Sous tasse à déjeuner

	x 6	<b>1,40 €</b>
--	-----	---------------

## Habana

En verre trempé.



Bol

<b>61346P</b> E Ø 13,5 cm - 49 cl	x 6	<b>P.U.HT</b>
		<b>1,30 €</b>





# HEAT SYSTEM

## Assiette santé

Une vaisselle en porcelaine culinaire tout spécialement adaptée aux établissements liés à la santé.



Assiette santé  
**1002692** E Ø 23 cm - H. 2,2 cm x 6 **P.U.HT 10,00 €**



Cloche bleue en polyamide  
**1002702P** E Ø 24,3 cm - H. 4,6 cm x 12 **P.U.HT 11,60 €**

## Heat system

ARCOROC

En opal, compatible avec les chariots de maintien en température.



Assiette carrée  
**1011517** E L. 20 x l. 20 cm - H. 3 cm x 24 **P.U.HT 3,10 €**



Assiette à compartiments  
**1011515** E Ø 23 cm - H. 2,5 cm x 24 **P.U.HT 5,90 €**



Assiette semi creuse  
**1011516** E Ø 25 cm - H. 2,8 cm x 24 **P.U.HT 3,10 €**



Bol  
**1011562** E Ø 12 cm - H. 6,2 cm - 40 cl x 24 **P.U.HT 1,60 €**



Assiette plate 2 compartiments  
**65125P** E Ø 23 cm x 24 **P.U.HT 6,50 €**



Assiette plate  
**65124P** E Ø 23 cm x 6 **P.U.HT 5,80 €**

## Vaisselle régithermie



En porcelaine crème.

Fond thermique



Assiette plate 3 compartiments  
**1002746** E Ø 24 cm - H. 2,6 cm x 6 **P.U.HT 9,30 €**



Assiette plate 2 compartiments  
**1000082P** E Ø 22,8 cm - H. 2,5 cm x 12 **P.U.HT 7,50 €**



Assiette plate bassin Ø 20,8 cm  
**1000081P** E Ø 22,8 cm - H. 2,6 cm x 12 **P.U.HT 6,60 €**



Assiette plate bassin Ø 17 cm  
**1000080P** E Ø 22,8 cm - H. 2,2 cm x 12 **P.U.HT 6,40 €**





## Wave

En mélamine. Mat à l'extérieur et brillant à l'intérieur.

**PLATEX**  
1<sup>er</sup> Fabricant Français de Plateaux



Assiette - Blanc  **P.U.HT**  
**1011780** Ø 26 cm x 4 **14,00 €**  
**1011779** Ø 22 cm x 6 **11,20 €**



Assiette - Noir / blanc  **P.U.HT**  
**1011786** Ø 26 cm x 4 **14,00 €**  
**1011785** Ø 22 cm x 6 **11,20 €**



Assiette - Gris anthracite / blanc  **P.U.HT**  
**1011792** Ø 26 cm x 4 **14,00 €**  
**1011791** Ø 22 cm x 6 **11,20 €**



Bol - Blanc  **P.U.HT**  
**1011782** Ø 15 cm x 6 **8,30 €**  
**1011781** Ø 12 cm x 6 **6,50 €**



Bol - Noir / blanc  **P.U.HT**  
**1011788** Ø 15 cm x 6 **8,30 €**  
**1011787** Ø 12 cm x 6 **6,50 €**



Bol - Gris anthracite / blanc  **P.U.HT**  
**1011794** Ø 15 cm x 6 **8,30 €**  
**1011793** Ø 12 cm x 6 **6,50 €**



## Prestige

En mélamine.

**PLATEX**  
1<sup>er</sup> Fabricant Français de Plateaux



Tasse à expresso  **P.U.HT**  
**1011775** 8 cl x 12 **3,90 €**

Sous-tasse à expresso  **P.U.HT**  
**1011777** Ø 11,5 cm x 12 **2,60 €**

Tasse à thé  **P.U.HT**  
**1013641** 23 cl x 12 **5,60 €**

Sous-tasse à thé  **P.U.HT**  
**1013642** Ø 15 cm x 12 **4,00 €**



Tasse à expresso  **P.U.HT**  
**1011776** 8 cl x 12 **3,90 €**

Sous-tasse à expresso  **P.U.HT**  
**1011778** Ø 11,5 cm x 12 **2,60 €**

La vaisselle en mélamine est particulièrement adaptée à un usage intensif. Elle est légère, solide, résistante aux chocs et supporte des températures jusqu'à 120°C ! Elle passe dans tous les lave-vaisselle. L'emploi du micro-ondes est déconseillé. Parfaitement neutre, sans odeur, ni goût, elle est garantie alimentaire.



## Vaisselle

En mélamine.



Assiette ronde Ø 22,5 cm  **P.U.HT**  
**1000267P** E Jaune x 12 **7,20 €**  
**1000266P** E Blanc x 12 **6,90 €**



Assiette carrée L. 13,5 x l. 13,5 cm  **P.U.HT**  
**1000263P** E Blanc x 12 **3,60 €**



Coupelle à sauce Ø 6,5 cm  **P.U.HT**  
**1000262P** E Blanc x 24 **2,00 €**



Bol Ø 12 x H. 5,8 cm - 42 cl  **P.U.HT**  
**1000270P** E Jaune x 24 **5,80 €**  
**1000269P** E Blanc x 12 **5,60 €**



Bol à oreille Ø 12,5 x H. 6,3 cm - 35 cl  **P.U.HT**  
**1000272P** E Blanc x 24 **4,10 €**



Gobelet Ø 7 cm x H. 8,4 cm - 20 cl  **P.U.HT**  
**1000274P** E Jaune x 12 **3,70 €**  
**1000273P** E Blanc x 12 **3,80 €**



# Vaisselle enfant Souris verte

PLASTOREX

En copolyester (sans Bisphénol A) ou en mélamine.  
Fabrication française.



Assiette plate (sans BPA)  
1000778 E Ø 18,5 cm x 12 **P.U.HT**  
7,20 €



Assiette à bouillie  
1000781 E Ø 18,5 cm x 12 **P.U.HT**  
6,50 €



Assiette creuse  
1005618 E Ø 18,5 cm x 12 **P.U.HT**  
6,40 €



Assiette 3 compartiments  
1005617 E Ø 21,5 cm x 12 **P.U.HT**  
7,60 €



Plateau repas  
1000787 E L. 24,8 x l. 20,9 cm x 6 **P.U.HT**  
10,60 €



Gobelet  
1000780 E A - 15 cl (sans BPA) x 12 **P.U.HT**  
3,90 €  
1000783 E B - 16 cl x 12 **P.U.HT**  
3,80 €



Bol à oreille  
1000782 E A - 45 cl x 12 **P.U.HT**  
6,20 €  
1000779 E B - 35 cl (sans BPA) x 12 **P.U.HT**  
6,90 €

# Vaisselle enfant

Une gamme de vaisselle souple et légère, adaptée à la petite enfance.

PLASTOREX

Made in France

PP

100%



Pichet empilable 100 cl  
1010482 E Blanc x 6 **P.U.HT**  
4,30 €  
1010483 E Rouge x 6 **P.U.HT**  
4,30 €  
1010484 E Bleu x 6 **P.U.HT**  
4,30 €  
1010485 E Vert x 6 **P.U.HT**  
4,30 €



Assiette Ø 18.5 cm  
1010486 E Blanc x 12 **P.U.HT**  
2,40 €  
1010487 E Rouge x 12 **P.U.HT**  
2,40 €  
1010488 E Bleu x 12 **P.U.HT**  
2,40 €  
1010489 E Vert x 12 **P.U.HT**  
2,40 €



Couvre assiette  
Ø 18,8 x H. 3 cm  
1010490 E Translucide x 12 **P.U.HT**  
2,00 €



Bol à oreilles 50 cl  
Ø 12 x H. 7 cm  
1010491 E Blanc x 12 **P.U.HT**  
3,60 €  
1010492 E Rouge x 12 **P.U.HT**  
3,60 €  
1010493 E Bleu x 12 **P.U.HT**  
3,60 €  
1010494 E Vert x 12 **P.U.HT**  
3,60 €



Couvercle pour bol Ø 12 cm  
1010499 E Translucide x 12 **P.U.HT**  
2,20 €



Cuillère embout souple L. 15,5 cm  
1007400 E Vert x 12 **P.U.HT**  
3,00 €  
1007401 E Fuchsia x 12 **P.U.HT**  
3,00 €  
1007403 E Bleu x 12 **P.U.HT**  
3,00 €



Couvert enfants L. 14,5 cm  
1005610P E Cuillère x 12 **P.U.HT**  
1,40 €  
1005609P E Fourchette x 12 **P.U.HT**  
1,40 €  
1005611P E Couteau x 12 **P.U.HT**  
1,40 €



Gobelet empilable 16 cl  
Ø 6,3 x H. 8,5 cm  
1010478 E Blanc x 24 **P.U.HT**  
1,70 €  
1010479 E Rouge x 24 **P.U.HT**  
1,70 €  
1010480 E Bleu x 24 **P.U.HT**  
1,70 €  
1010481 E Vert x 24 **P.U.HT**  
1,70 €



Tasse inversable 20 cl - Ø 11 cm  
1005635 E Vert x 12 **P.U.HT**  
5,80 €  
1005636 E Tilleul x 12 **P.U.HT**  
5,80 €  
1005637 E Fuchsia x 12 **P.U.HT**  
5,80 €  
1005638 E Violet x 12 **P.U.HT**  
5,80 €

VAISSELLE INCASSABLE



ART DE LA TABLE



## Assiette carrée

En copolyester. Sans phtalate, sans bisphénol A. Stabilité idéale grâce à la base antidérapante. Espace de préhension.



Sans Bisphénol A



	L. 23,5 x l. 23,5 x H. 2,5 cm	📦	P.U. HT
Blanc	1000083	E x 12	10,70 €
Anis	1000084	E x 12	10,70 €
Bleu	1000085	E x 12	10,70 €
Orange	1000086	E x 12	10,70 €

## Assiette 3 compartiments

En copolyester. Sans antidérapant. Existe en 2 compartiments et/ou avec antidérapant : nous consulter. Assiette adaptée pour les crêches.



Sans Bisphénol A



	Ø 23,5 cm	📦	P.U. HT
Orange	1002266	x 15	9,50 €
Cassis	1002265	x 15	9,50 €
Bleu	1002264	x 15	9,50 €
Blanc	1002263	x 15	9,50 €

## Assiette anti-dérapante

En copolyester. Pente spéciale pour la nourriture vers la partie la plus profonde et angle de blocage pour la cuillère et la fourchette.



Sans Bisphénol A



	Ø 23,5 x H. 4 cm	📦	P.U. HT
Bleu	70661	E x 12	12,00 €
Cassis	70663	E x 12	12,00 €
Orange	70664	E x 12	12,00 €
Blanc	70660	E x 12	12,00 €

## Assiette

En copolyester.



Sans Bisphénol A



	Ø 23 cm	Ø 18 cm	Ø 13,4 cm
Bleu	70666 €	70672 €	70678 €
Jaune	70667 €	70674 €	70680 €
Vert	70669 €	70676 €	70682 €
Blanc	70665 €	70671 €	70677 €
Orange	70668 €	70675 €	70681 €
📦	x 30	x 30	x 30
P.U. HT	6,20 €	4,10 €	3,60 €

## Cloche pour assiette 23,5 cm carrée ou ronde

Cloche de protection et de maintien de température. Sans phtalate, sans bisphénol A. Maintien de la chaleur grâce aux crochets de positionnement. Empilabilité et stockage d'assiettes possible avec la cloche en position.



Sans Bisphénol A



1000087	E Ø 24 x H. 5 cm	📦	P.U. HT
		x 6	8,30 €

## Vaisselle

En copolyester. Couverture vendu séparément.



Sans Bisphénol A



Ravier rectangulaire  
14,5 x 9,5 cm  
32 cl

Ravier carré  
9,7 x 9,7 cm  
25 cl

Ramequin  
Ø 8,6 cm  
16 cl

Bleu	70755 E	70749 E	70743 E
Jaune	70757 E	70751 E	70745 E
Vert	70759 E	70753 E	70747 E
Blanc	70754P E	70748P E	70742 E
Orange	70758 E	70752 E	70746 E

x 48 x 48 x 48

P.U.HT 4,90 € 4,10 € 3,50 €



Couvercle ravier rectangulaire

Couvercle ravier carré

Couvercle ramequin

1002267 E 1002268 E 1002269

x 48 x 48 x 48

P.U.HT 1,60 € 1,40 € 1,30 €



Comptiotier 10 cl  
Ø 12 cm

Bol 45 cl sans couvercle

Couvercle seul pour bol 45 cl

Bleu	70704 E	70684P E	70689 E
Jaune	70706 E	70686P E	70692 E
Vert	70708 E	70688P E	70693 E
Blanc	70703 E	70683P E	-
Orange	70707 E	70687 E	70691 E

x 48 x 25 x 25

P.U.HT 3,40 € 4,80 € 2,10 €



## Gobelet

En copolyester.



Sans Bisphénol A



Tasse sans couvercle  
25 cl

Couvercle pour tasse  
Ø10 cm

Bleu	70695 E	70698 E
Cassis	70697 E	70700 E
Orange	70702 E	70701 E
Blanc	70694 E	-

x 12 x 12

P.U.HT 5,70 € 2,70 €



## Support anti-dérapant

Rend l'ouverture plus facile et accessible à tous.



Ø 4,5 x H. 4 cm

Blanc	68565	E x 10	6,00 €
Bleu	68562	E x 10	6,00 €
Orange	68563	E x 10	6,00 €
Cassis	68564	E x 10	6,00 €

## Vaisselle thermodynamique

Avec couvercle. Sans Bisphénol A.



Assiette creuse Ø 23 cm			P.U.HT	Bol Ø 18 x H. 8 cm - 32 cl			P.U.HT
64667	E Bleu	x 6	34,75 €	64662	E Bleu	x 6	28,00 €
64671	E Anis	x 6	34,75 €	64663	E Anis	x 6	28,00 €
64668	E Cassis	x 6	34,75 €	64665	E Cassis	x 6	28,00 €
64669	E Blanc	x 6	34,75 €	64666	E Blanc	x 6	28,00 €
64670	E Orange	x 6	34,75 €	64664	E Orange	x 6	28,00 €

Ralentit la perte des calories et des frigories. Base antidérapante pour une stabilité optimale. Fermeture totale = sécurité, passe au micro-ondes et lave-vaisselle.



## Shoreline



Mug isotherme Ø 8,9 x H. 10,16 cm - 24 cl

68295	Bleu marine	x 48	P.U.HT 4,70 €
68296	Cerise	x 48	4,70 €



Bol isotherme Ø 8,89 x H. 6,03 cm - 15 cl

68299	Bleu marine	x 48	P.U.HT 4,80 €
68298	Cerise	x 48	4,80 €



Bol isotherme Ø 13,34 x H. 6,1 cm - 27 cl

68287	Bleu marine	x 48	P.U.HT 4,80 €
68297	Cerise	x 48	4,80 €



Couvercle. Carton de 240

68286	Pour bol 27 cl	x 1	P.U.HT 240,00 €
68283	Pour mugs et bols 15 cl	x 1	164,00 €



Dôme isotherme Ø 25,9 x H. 7,3 cm

68284	Bleu marine	x 12	P.U.HT 27,75 €
68293	Rouge cerise	x 12	27,75 €



Sous-dôme isotherme Ø 24,3 x H. 4,6 cm

68282	Rouge cerise	x 12	P.U.HT 13,90 €
68280	Bleu marine	x 12	13,90 €



Plaque chauffante thermique

68281	Ø 24 cm Ø bassin 23 cm - Matière smc haute densité. Couleur Gris	H. 4,45 cm	x 12	P.U.HT 66,00 €
-------	--	------------	------	----------------

68285	Lève-plaque chauffante	H. 7,6 cm l. 8 cm - Matière plastique - Poids 0,18 kg	x 1	P.U.HT 127,00 €
-------	------------------------	---	-----	-----------------

Système isotherme SHORELINE pour maintenir en température les plats chauds pendant 60 minutes à 65°C à coeur. Système isotherme pour assiette Ø 23 cm : dôme à poignée ergonomique pour faciliter la préhension. Injecté de mousse polyuréthane pour un maintien en température efficace. La plaque chauffante thermique assure des températures supérieures à 65°C pendant plus d'une heure. Pour une conservation optimale, réchauffez l'assiette à +80/90°C avant d'y placer les aliments chauffés à 85°C. Le sous-dôme soutient fermement la plaque. Le lève-plaque permet de manipuler les plaques chauffantes ou les assiettes chaudes.



## Assiette à compartiments

En porcelaine blanche.



68277P L. 36,5 x l. 21,5 cm

x 4

P.U.HT  
13,00 €



68279P L. 35,5 x l. 23 cm

x 4

P.U.HT  
14,50 €

## Assiette à entrecôte

En porcelaine blanche.



69543P L. 31 x l. 20 cm  
69542P L. 28 x l. 19 cm

x 4  
x 4

P.U.HT  
14,50 €  
9,80 €

## Assiette à steak

En porcelaine blanche.



63414P L. 30 x l. 25,5 cm

x 6

P.U.HT  
3,40 €

## Assiette à entrecôte

En grès.



L. 34,5 x l. 23,5 cm

1010315P Rouge  
1010317P Bleu nuit

x 6  
x 6

P.U.HT  
10,10 €  
10,10 €

## Snack

En porcelaine blanche.



Assiette et ravier  
1008382P L. 32 x l. 14 x H. 2 cm  
1008384P L. 13,6 x l. 13,6 x H. 5 cm

x 6  
x 6

P.U.HT  
10,50 €  
7,40 €

## Classic

Lavable en machine, passe au micro-ondes et sous lampe chauffante jusqu'à 65°C.



L. 24 x l. 15 x H. 5 cm  
1011073P E Rouge

x 6

P.U.HT  
0,70 €



L. 22 x l. 15 x H. 4 cm  
1011072P Noir

x 6

P.U.HT  
0,85 €

## EN MODE STEAK HOUSE

### Panier à friture

En inox.



A 1006161P L. 13 x l. 10 x H. 8,5 cm x 1  
A 1002338P L. 10 x l. 8,8 x H. 5,5 cm x 12  
B 1006684P Ø 11 x H. 15 cm x 1  
C 1002336P Ø 8 x H. 8,5 cm x 12

P.U.HT  
10,60 €  
7,40 €  
7,90 €  
7,40 €

### Gobelet à frites

En porcelaine blanche.



1002339P Ø 8 x H. 13 cm - 24 cl

x 4

P.U.HT  
4,20 €

### Papier alimentaire



Pour cône  
L. 18 x l. 17 cm - Carton de 2000  
A 1002427P Journal x 1 99,00 €  
C 1002426P Kraft x 1 99,00 €  
D 1002425 Blanc x 1 99,00 €

Pour panier de 8 et 10 cm  
L. 14 x l. 13 cm - Carton de 2000  
B 1006213P Journal x 1 75,00 €  
C 1002422P Kraft x 1 79,00 €  
D 1002424P Blanc x 1 79,00 €

### Jumbo

Lame inox orantée de 11,8 cm.



Couteau à steak  
1011619P x 12 2,60 €

### Grès couleur



Pot à sauce  
Ø 5 x H. 4,5 cm - 5 cl  
1005514P Rouge x 12 2,60 €  
1005513P Bleu x 12 2,60 €

### Pot inox



Sauce  
1006647P Ø 7 x H. 5 cm - 10 cl x 24 2,40 €  
Frites  
1006646P Ø 9 x H. 8,5 cm x 6 8,10 €

### Pic steak

En bois et papier 65 mm.

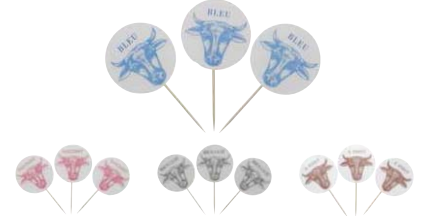

Boîte de 100  
65114P Bleu x 1 4,40 €  
65115P Saignant x 1 4,40 €  
65116P Bien cuit x 1 4,40 €  
65117P A point x 1 4,40 €

### Porte brochettes

Avec plateau et 2 porte-sauces en bois.  
Pour ramequin Ø 8 cm max.  
Livré sans ramequin.



62116 L. 37 x l. 27 x H. 43 cm x 1 70,00 €

### Brochette

En inox.



Sachet de 12  
69286P L. 35 cm x 1 14,70 €  
69285P L. 30 cm x 1 13,90 €

### Brochette

En bambou.



Boîte de 100  
65090P L. 30 cm x 1 1,80 €

### nouveau !

### Olivier

En bois d'olivier.

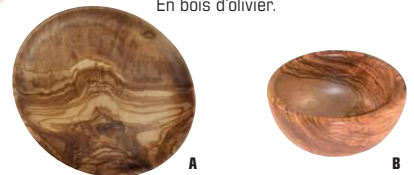

Assiette plate  
A 1013188 Ø 18 cm x 3 22,25 €  
A 1013187 Ø 14 cm x 3 15,00 €  
Coupelle  
B 1013189 Ø 11 cm x 4 18,00 €



**Basalt**

En porcelaine couleur ardoise.



Assiette à pizza  
**69797P** Ø 32 cm

x 2

P.U.HT  
**20,75 €**

**Banquet**

En porcelaine crème.



Assiette à pizza  
**70157P** Ø 33 cm  
**59202P** Ø 30,5 cm

x 6  
x 6

P.U.HT  
**6,80 €**  
**6,10 €**

**Filets**

En porcelaine.  
Filet vert et rouge.



Assiette à pizza  
**51763P** Ø 30 cm  
**44371P** Ø 27 cm

x 12  
x 12

P.U.HT  
**6,40 €**  
**5,60 €**

**Intensity Zen**

En Zénix.



Assiette à pizza  
**70466P** Ø 32 x H. 1,7 cm

x 6

P.U.HT  
**4,50 €**

**Grès couleur**

En grès émaillé rouge.



Assiette à pizza  
**1010316P** Ø 33 cm

x 6

P.U.HT  
**10,40 €**

**Diamond**

En verre.



Assiette à pizza  
**1005343P** Ø 33 cm

x 6

P.U.HT  
**4,60 €**

**Assiette à pizza**

En porcelaine blanche.



**63279P** Ø 31,5 cm  
**63320P** Ø 27 cm

x 6  
x 12

P.U.HT  
**3,00 €**  
**3,40 €**

**Artesano**

En porcelaine crème.



Assiette à pâtes  
**1010312** Ø 30,5 cm  
**1010313** Ø 27 cm

x 2  
x 2

P.U.HT  
**28,00 €**  
**12,70 €**



Assiette à spaghetti  
**1010311** L. 30,7 x l. 26,3 x H. 5,7 cm

x 2

P.U.HT  
**14,70 €**



**Assiette à pâtes / risotto**

En porcelaine blanche.



Assiette creuse  
**1001601P** Ø 30 cm - Bassin Ø 18 cm  
**1001602P** Ø 26 cm - Bassin Ø 16 cm

x 6  
x 12

P.U.HT  
**4,30 €**  
**3,20 €**

**Assiette Gourmet**

En porcelaine blanche.

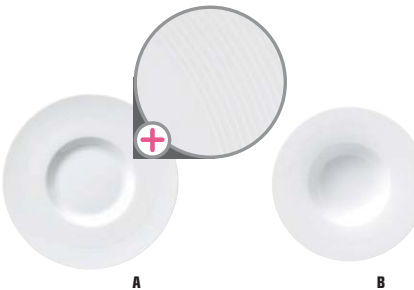

Assiette plate  
**1001600P** Ø 31 cm - Bassin Ø 15 cm

x 12

P.U.HT  
**5,60 €**

Assiette creuse  
**1001598P** Ø 27 cm - Bassin Ø 14 cm  
**1001599P** Ø 22 cm - Bassin Ø 11,5 cm

x 12  
x 12

P.U.HT  
**4,30 €**  
**3,20 €**

**Tendency**

En Zénix.



Assiette à pâtes  
**68744P** Ø 28 cm

x 6

P.U.HT  
**6,20 €**



**Smooth**

En porcelaine blanche.



Assiette à carpaccio  
**1008383P** Ø 29 cm

x 6

P.U.HT  
**12,70 €**

**Couteau à pizza**

Lame inox.



**49375P** L. lame 11 cm

x 12

P.U.HT  
**3,50 €**

**Fromagère**

En verre avec couvercle et support en inox 18/0.



Fromagère avec couvercle et cuillère  
**1005710P** Ø 11 x H. 7 cm - 15 cl

x 1

P.U.HT  
**16,00 €**

Verre de rechange  
**1005711P** Ø 9 x H. 5 cm

x 1

P.U.HT  
**4,70 €**

**Saupoudreuse parmesan**

En verre, bouchon inox.



**59088P** Ø 7,5 x H. 13,5 cm

x 1

P.U.HT  
**6,40 €**

**Spray**

En verre et inox.



Spray huile ou vinaigre  
**1002257P** H. 19,3 cm - 17 cl

x 1

P.U.HT  
**12,00 €**

**Huilier Optima**

En verre blanc, bouchon silicone avec bec verseur inox.



**1002470P** H. 14,3 cm - 25 cl

x 12

P.U.HT  
**3,50 €**

**Pot lyonnais**

En verre sodocalcique.



**1818P** Ø 7,5 x H. 29 cm - 46 cl  
**1001405P** Bec verseur Inox

x 6  
x 1

P.U.HT  
**4,60 €**  
**2,70 €**



### Impulse

En porcelaine blanche.



Assiette ronde à huîtres  
1002530P Ø 26 cm

x 6 P.U.HT  
20,75 €

### Folia

En porcelaine blanche.



Assiette  
68111P E L. 36,5 x l. 21 cm

x 6 P.U.HT  
15,50 €

### Plateau à fruits de mer

En inox.



Plateau à fruits de mer  
56177P Ø 28 cm  
71199P Ø 42 cm  
56030P Ø 50 cm

x 1 P.U.HT  
8,10 €  
x 1 P.U.HT  
18,50 €  
x 1 P.U.HT  
29,50 €

Porte-plateau en acier chromé  
1002140P Ø 27 x H. 17,5 cm

x 1 P.U.HT  
7,90 €

### Marmite à moules

En acier émaillé.



69116P Ø 18 x H. 18 cm - 2,6 L

x 6 P.U.HT  
6,50 €

### Casse-pinces



A 50668P Acier chromé - L. 15 cm  
B 71198P Inox 18/10 - L. 16 cm

x 1 P.U.HT  
5,30 €  
x 1 P.U.HT  
12,50 €

### Casse-pattes à homard

En aluminium.



52658P L. 13,5 cm

x 1 P.U.HT  
5,10 €

### Pince à homard

Système de verrouillage.



63222P L. 18,5 cm

x 1 P.U.HT  
14,70 €

nouveau !

### Soup Passion

En porcelaine blanche résistante.



Bol  
1013086 L. 27,5 x l. 17,3 x H. 6,8 cm

x 2 P.U.HT  
13,10 €

### Sphère

En porcelaine blanche.



Plat à moules  
1008386P Ø 18 X H. 16 cm

x 1 P.U.HT  
23,50 €

### Curette à homard

En inox 18/0.

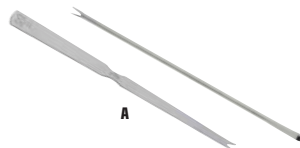

A 65257P L. 19,8 cm  
B 71172P L. 18,7 cm

x 24 P.U.HT  
3,20 €  
x 12 P.U.HT  
0,62 €

### Fourchette à huître Éco

En inox 18/0. Epaisseur 1,5 mm. Finition poli standard.



68042P

x 12 P.U.HT  
0,45 €

### Couteau à huître

Manche bois.



1011123P L. Lame 7 cm

x 1 P.U.HT  
9,40 €

Manche PP noir.



1011124P L. Lame 5,5 cm

x 1 P.U.HT  
2,20 €

### Plat à poisson

En porcelaine blanche.



1001391 L. 56 x l. 20 cm

x 1 P.U.HT  
51,50 €

### Pique bigorneaux

En plastique et inox 18/0.  
2 par couleur : blanc, noir, rouge, jaune, bleu, vert.



Paquet de 12  
71245P L. 7 cm

x 1 P.U.HT  
5,40 €

### Pique bigorneaux

Fil cuivré 1,2 mm pointe biseautée.

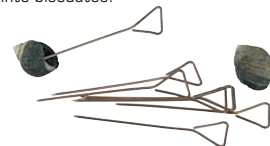

Paquet de 1000  
59538P L. 7 cm

x 1 P.U.HT  
22,25 €

### Presse-citron

En copolyester.



67246P Individuel  
67247P Boîte de 2

x 1 P.U.HT  
3,80 €  
x 12 P.U.HT  
7,60 €

Serviettes parfumées voir en page 520



### Rince doigts

Emballage individuel et hermétique. Sans parabène. Parfum citron. Lingette tissu crépé.



Paquet de 500  
1000177P L. 8 x l. 6 cm

x 1 P.U.HT  
18,00 €

## ASIE

### Panier vapeur

En bambou.



1005321P Ø 18 x H. 9 cm

x 1 P.U.HT  
12,30 €

### Baguette chinoise

En bambou. Sachet individuel.



Paquet de 1000  
1006607P L. 21 cm

x 1 P.U.HT  
55,00 €

## Appareil à raclette 1/2 fromage

Bloc de chauffe fixe monté sur un axe pivotant. Cordon électrique amovible 2,50 m. 230 V. Livré sans couteau.



Jusqu'à 8 personnes



1000 W  
**42693** L. 48,5 x l. 28 x H. 32 cm x 1 P.U.HT  
5,7 kg **210,00 €**

## Appareil à raclette 1/4 fromage

Porte-fromage nickelé à pointes monté sur un bras qui pivote. Livré sans couteau. 230 V.



Jusqu'à 4 personnes



1000 W  
**64130P** L. 21,5 x l. 44,5 x H. 30 cm x 1 P.U.HT  
3,2 kg **162,00 €**

Jusqu'à 4 personnes



600 W  
**42692P** L. 28 x l. 24 x H. 34 cm x 1 P.U.HT  
3 kg **171,00 €**

## Planchetta de table

Cuisson sur plaque en acier émaillé avec 2 brûleurs à alcool fournis.



Jusqu'à 4 personnes



**64132P** L. 33 x l. 22 x H. 14 cm x 1 P.U.HT  
4,4 kg **164,00 €**

## DÉJEUNER EN ALTITUDE

### Seille à patates

En bois naturel avec couvercle.



Ronde  
**64127P** Ø 20 x H. 17,5 cm x 1 P.U.HT  
**36,75 €**  
Ovale  
**64128** L. 25 x l. 17 x H. 18,5 cm x 1 **42,25 €**

### Guillotine à saucisson

En bois de hêtre.



**A 1006341** L. 28 x l. 28 x H. 11 cm x 1 P.U.HT  
**65,00 €**  
**B 1001535P** L. 28 x l. 16 x H. 10,5 cm x 1 **45,50 €**

### Planche Epicurean

En fibre de papier.



**1002161** L. 37 x l. 28 cm x 4 P.U.HT  
**28,25 €**  
**1002162P** L. 30 x l. 23 cm x 4 **20,00 €**  
**1002165** L. 20 x l. 15 cm x 4 **13,20 €**

### Couteau à raclette

En inox. Un côté pour racler et un côté microdenté pour couper.



**63171P** L. 24 cm x 1 P.U.HT  
**14,80 €**

### Grès couleur

En grès beige.



Assiette plate  
**58701P** Ø 27 cm x 12 P.U.HT  
**6,70 €**

### nouveau ! Spatule en bois



Paquet de 6  
**1013326P** x 1 P.U.HT  
**3,30 €**

### Réchaud à gaz

2000 W. 1,6 kg. Livré sans cartouche.



Réchaud à gaz  
**67612P** L. 34 x l. 28 x H. 12 cm x 1 P.U.HT  
**23,75 €**  
Cartouche gaz\*  
**67613P\*** 2/3 H de combustion x 28 P.U.HT  
**2,60 €**  
\* Dangereux. Respecter les précautions d'emploi. Produit conforme à la législation française.

Gels combustibles voir page 265



## Service à fondue



En fonte émaillée. Livré avec 1 caquelon, 1 collerette, 1 réchaud, 4 fourchettes pour Ø 16 cm ou 6 fourchettes pour les autres dimensions et 1 brûleur.



Noir  
**1011029** Ø 20 x H. 11,6 cm - 2,35 L x 1 P.U.HT  
**161,00 €**  
**1011027** Ø 18 x H. 10 cm - 1,65 L x 1 **145,00 €**  
**1011025** Ø 16 x H. 8,4 cm - 1,1 L x 1 **129,00 €**  
Rouge cerise  
**1011030** Ø 20 x H. 11,6 cm - 2,35 L x 1 P.U.HT  
**161,00 €**  
**1011028** Ø 18 x H. 10 cm - 1,65 L x 1 **145,00 €**  
**1011026** Ø 16 x H. 8,4 cm - 1,1 L x 1 **129,00 €**

## Service à fondue savoyarde



En fonte émaillée comprenant 1 caquelon, 1 réchaud, 1 brûleur à pâte (pâte non fournie) et 6 fourchettes. 4,9 kg.



Rouge  
**70213P** Ø 22,5 x H. 18 cm - 2,5 L x 1 P.U.HT  
**74,50 €**

## Caquelon

En fonte émaillée.



Rouge  
**70214P** Ø 21 x H. 8 cm - 2 L x 1 P.U.HT  
**35,75 €**  
**1010693P** Ø 18 x H. 8 cm - 1,2 L x 1 **30,25 €**

## Service à fondue bourguignonne



En fonte émaillée. Comprend : 1 caquelon, 1 couvercle anti-éclaboussure, 1 réchaud, 1 brûleur à pâte et 6 fourchettes. 4,1 kg.



Rouge  
**70789P** Ø 21 cm - 2 L x 1 P.U.HT  
**65,50 €**

## Fourchette à fondue

**A 59097P** 2 dents x 12 P.U.HT  
**2,60 €**  
**B 1008184P** 3 dents - Lot de 6 x 1 **12,60 €**



# CHEF'S FUSION



## Néofusion

En porcelaine.



Plat à oreilles

L. 25 x l 14 x H. 4,3cm - 42 cl

**1007267** Noir



x 24

**P.U.HT**  
**16,25 €**

## Chef's Fusion

En porcelaine.



Poêlon rond

Ø 24 cm

		x 6	<b>P.U.HT</b>
<b>1009591</b>	Blanc	x 6	<b>22,00 €</b>
<b>1009592P</b>	Noir	x 6	<b>22,00 €</b>
<b>1009689P</b>	Gris	x 6	<b>22,00 €</b>
<b>1009690</b>	Rouge	x 6	<b>22,00 €</b>

Ø 16 cm

		x 6	<b>P.U.HT</b>
<b>1009589</b>	Blanc	x 6	<b>18,25 €</b>
<b>1009590P</b>	Noir	x 6	<b>18,25 €</b>
<b>1009687P</b>	Gris	x 6	<b>18,25 €</b>
<b>1009688</b>	Rouge	x 6	<b>18,25 €</b>

Ø 12 cm

		x 12	<b>P.U.HT</b>
<b>1009587</b>	Blanc	x 12	<b>11,20 €</b>
<b>1009588P</b>	Noir	x 12	<b>11,20 €</b>
<b>1009685</b>	Gris	x 12	<b>11,20 €</b>
<b>1009686</b>	Rouge	x 12	<b>11,20 €</b>



Cocotte avec couvercle

Ø 10 cm - 21,6 cl

		x 12	<b>P.U.HT</b>
<b>1009600</b>	Blanc	x 12	<b>12,20 €</b>
<b>1009602</b>	Noir	x 12	<b>12,20 €</b>
<b>1009601</b>	Gris	x 12	<b>12,20 €</b>

Ø 16 cm - 46,7 cl

		x 4	<b>P.U.HT</b>
<b>1009604</b>	Blanc	x 4	<b>17,00 €</b>
<b>1012601P</b>	Noir	x 4	<b>17,00 €</b>
<b>1009605P</b>	Gris	x 4	<b>17,00 €</b>



Cocotte sans couvercle

Ø 16 cm - 46,7 cl

		x 4	<b>P.U.HT</b>
<b>1009624</b>	Blanc	x 4	<b>13,20 €</b>
<b>1009626P</b>	Noir	x 4	<b>13,20 €</b>
<b>1009625</b>	Gris	x 4	<b>13,20 €</b>



Couvercle pour cocotte

Ø 16 cm

		x 6	<b>P.U.HT</b>
<b>1009641</b>	Blanc	x 6	<b>3,70 €</b>
<b>1009643</b>	Noir	x 6	<b>3,70 €</b>
<b>1009642</b>	Gris	x 6	<b>3,70 €</b>





# CHEF'S FUSION

## Chef's Fusion

En porcelaine.



### Soupière avec couvercle

Ø 10,6 cm - 45 cl

			P.U. HT
<b>1009593P</b>	Blanc	x 2	19,50 €
<b>1009594P</b>	Noir	x 2	19,50 €
<b>1009711</b>	Gris	x 2	19,50 €
<b>1009712</b>	Rouge	x 2	19,50 €



### Ramequin plissé

Ø 9 cm - 20,5 cl

			P.U. HT
<b>1009698</b>	Blanc	x 12	7,70 €
<b>1009700</b>	Noir	x 12	7,70 €
<b>1009699</b>	Gris	x 12	7,70 €
<b>1009701</b>	Rouge	x 12	7,70 €



### Terrine sans couvercle

L. 20 x l. 10 cm

			P.U. HT
<b>1009748</b>	Blanc	x 1	12,80 €
<b>1009745</b>	Noir	x 1	12,80 €



### Couvercle pour terrine

L. 20 x l. 10 cm

			P.U. HT
<b>1009752</b>	Blanc	x 6	3,10 €
<b>1009749</b>	Noir	x 6	3,10 €



## Matière à cuisiner

La porcelaine culinaire de REVOL est la marque de fabrique des cuisines authentiques, richesse gustative de la gastronomie française. Matière à cuisiner, elle se réinvente dans les formes et finitions, elle habille les tables contemporaines de mille saveurs emblématiques.



REVOL



**Belle cuisine**  
En porcelaine culinaire.



**BELLE CUISINE**



**Cocotte avec couvercle**  
**57151** L. 13,5 x l. 12,2 x H. 8 cm - 45 cl



**P.U.HT**  
**23,00 €**



**Cassiolette ovale**  
**68652** L. 14,5 x l. 13 x H. 3 cm - 25 cl



**P.U.HT**  
**9,90 €**

**nouveau !**



**Wok**  
**1001170P** Ø 20 x H. 7 cm - 1 L



**P.U.HT**  
**23,00 €**



**Plat rectangulaire**  
**54174P** L. 19 x l. 12,5 x H. 5 cm - 70 cl  
**54175P** L. 16 x l. 11 x H. 4,5 cm - 45 cl



**P.U.HT**  
**14,00 €**  
**11,30 €**



**Ramequin**  
**68658P** Ø 9,4 x H. 4,3 cm - 15 cl



**P.U.HT**  
**7,90 €**



**Wok**  
**1005054** Ø 20 x H. 7 cm - 1 L



**P.U.HT**  
**20,00 €**



**Plat rectangulaire**  
**68655P** L. 16 x l. 11 x H. 4,5 cm - 45 cl



**P.U.HT**  
**12,40 €**



**Ravier rectangulaire**  
**66043** L. 12 x l. 10 x H. 4,5 cm - 33 cl



**P.U.HT**  
**9,60 €**



**Baby wok**  
**1003750** Ø 16 x H. 5,5 cm - 50 cl



**P.U.HT**  
**16,00 €**



**Cassiolette ovale**  
**54172** L. 14,5 x l. 13 x H. 3 cm - 25 cl



**P.U.HT**  
**9,00 €**



**Ravier rectangulaire**  
**1002562** L. 12 x l. 10 x H. 4,5 cm - 33 cl



**P.U.HT**  
**10,50 €**



**Baby wok**  
**1005051** Ø 16 x H. 5,5 cm - 50 cl



**P.U.HT**  
**14,10 €**





RÉVOLUTION

## Révolution

En porcelaine culinaire.



Sauteuse avec couvercle

Ø 22,3 x H. 10 cm - 80 cl

**1010517** Noir

x 1

**P.U.HT**  
**67,50 €**



Cocotte avec couvercle en verre

Ø 26 x H. 14,5 cm - 340 cl

**1002678** Blanc

x 1

**P.U.HT**  
**92,50 €**



Cocotte noire sans couvercle

**1010516** Ø 19 x H. 9 cm - 150 cl  
**1005747** Ø 16,4 x H. 7,2 cm - 80 cl  
**1005753** Ø 13 x H. 6,6 cm - 50 cl  
**1005746** Ø 10 x H. 5 cm - 20 cl

x 1  
x 4  
x 4  
x 4

**P.U.HT**  
**24,75 €**  
**20,25 €**  
**14,10 €**  
**10,30 €**

Couvercle

**1010518** Ø 19 cm - Noir  
**1005750** Ø 16 cm - Noir  
**1005749** Ø 13,6 cm - Noir  
**1005748** Ø 10 cm - Noir

x 1  
x 1  
x 1  
x 1

**P.U.HT**  
**25,00 €**  
**19,50 €**  
**16,75 €**  
**13,10 €**



# Bistronome

En grès émaillé.

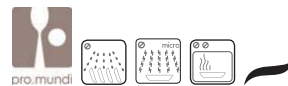

## Plat rectangulaire

L. 20 x l. 14 x H. 5 cm - 90 cl

			P.U.HT
🛒 69467P	Gris	x 4	8,00 €
🛒 69466P	Blanc	x 4	7,20 €



## Cassiole crème brûlée

Ø 14 x H. 3 cm - 28 cl

			P.U.HT
🛒 69454P	Gris	x 6	4,90 €
🛒 69453P	Blanc	x 6	4,40 €



## Ramequin lisse gris

			P.U.HT
🛒 69476P	Ø 9 x H. 5 cm - 19 cl	x 12	2,30 €
🛒 69475P	Ø 7 x H. 3,5 cm - 8 cl	x 12	1,70 €



## Plat rond 85 cl

Ø 18 x H. 5,5 cm

			P.U.HT
🛒 69469P	Gris	x 4	7,20 €
🛒 69468P	Blanc	x 4	6,60 €

## Ramequin lisse blanc

			P.U.HT
🛒 58197P	Ø 9 cm - 19 cl	x 12	1,90 €
🛒 57515P	E Ø 7 cm - 8 cl	x 12	1,40 €



## Ramequin lisse jaune

			P.U.HT
🛒 53665P	E Ø 9 cm - 19 cl	x 12	2,30 €
🛒 53663P	E Ø 7 cm - 8 cl	x 12	1,70 €



## Cocotte avec couvercle

### Gris

			P.U.HT
🛒 69460P	Ø 17 x H. 8 cm - 110 cl	x 2	19,50 €
🛒 69458P	Ø 14 x H. 5 cm - 44 cl	x 2	7,20 €
🛒 69456P	Ø 10 x H. 4,5 cm - 18 cl	x 6	4,30 €

### Blanche

			P.U.HT
🛒 69459P	Ø 17 x H. 8 cm - 110 cl	x 2	16,50 €
🛒 69457P	Ø 14 x H. 5 cm - 44 cl	x 2	6,60 €
🛒 69455P	Ø 10 x H. 4,5 cm - 18 cl	x 6	3,50 €

## Ramequin lisse vert

			P.U.HT
🛒 53666P	E Ø 9 cm - 19 cl	x 12	2,30 €
🛒 53664P	E Ø 7 cm - 8 cl	x 12	1,70 €



## Ramequin plissé gris

			P.U.HT
🛒 69474P	Ø 10,5 x H. 5 cm - 19 cl	x 12	2,90 €
🛒 69473P	Ø 8,5 x H. 4,5 cm - 14 cl	x 12	2,50 €



## Ramequin plissé blanc

			P.U.HT
🛒 396P	E Ø 10,5 x H. 5 cm - 19 cl	x 12	2,90 €
🛒 395P	E Ø 8,5 x H. 4,5 cm - 14 cl	x 12	2,50 €
🛒 53654P	E Ø 7 cm - 7 cl	x 12	1,40 €



VERRE



**Pyrex**  
En verre borosilicate.



Cocotte ronde avec couvercle  
**1001637P** Ø 17,8 x H. 8,3 cm - 100 cl x 1

P.U.HT  
**7,20 €**



Plat à gratin ovale  
**64235P** L. 21 x l. 13 x H. 4,7 cm x 10

P.U.HT  
**5,10 €**

PORCELAINE



**1<sup>er</sup> PRIX**  
**Terrine foie gras**  
En porcelaine blanche.



<b>69377P</b>	L. 17 x l. 12 x H. 7 cm - 72 cl	x 6	<b>18,00 €</b>
<b>69376P</b>	L. 13 x l. 10 x H. 6 cm - 40 cl	x 6	<b>9,80 €</b>
<b>69375P</b>	L. 11 x l. 8 x H. 5 cm - 18 cl	x 6	<b>7,20 €</b>

**Plat sabot ovale**  
En porcelaine blanche



**62097P** E L. 32 x l. 22,5 x H. 5,8 cm x 2 **21,50 €**

**Terrine Allspice**  
En porcelaine crème.



Terrine Chef's Fusion voir page 101



<b>66192</b>	L. 19,5 x l. 15,4 x H. 11 cm - 100 cl	x 2	<b>28,25 €</b>
<b>64582</b>	L. 16,4 x l. 13,5 x H. 7,2 cm - 66 cl	x 2	<b>22,75 €</b>
<b>66191</b>	L. 15 x l. 11,8 x H. 9 cm - 40 cl	x 2	<b>17,00 €</b>
<b>66190</b>	L. 13 x l. 10 x H. 7,7 cm - 30 cl	x 2	<b>14,10 €</b>
<b>66189</b>	L. 11,7 x l. 9,2 x H. 7 cm - 20 cl	x 2	<b>11,30 €</b>

Gamme de terrines à couvercle, sans bourrelet, en porcelaine extra-résistante. Dessinée par Alain et Dominique Vavro et élaborée avec la maison Masse, cette gamme de terrine est particulièrement adaptée au service du foie gras mais aussi à toutes les présentations culinaires. Peut passer au four et à la salamandre. La terrine de 66 cl est spécialement adaptée pour les lobes de 500 g, la terrine de 100 cl pour 2 lobes de 500g.

**Plat sabot**  
En porcelaine blanche.



<b>684</b>	L. 37 x l. 27 cm - 325 cl	x 1	<b>27,00 €</b>
<b>683</b>	L. 32 x l. 23 cm - 200 cl	x 1	<b>18,50 €</b>
<b>682</b>	L. 26 x l. 19 cm - 150 cl	x 1	<b>13,10 €</b>
<b>41474</b>	L. 14 x l. 10 cm - 110 cl	x 6	<b>9,00 €</b>

**Plat sabot Cafett**

En porcelaine. Encoche latérale pour une meilleure préhension.



<b>69470P</b>	E L. 23 x l. 16,5 x H. 5 cm - 92 cl	x 6	<b>7,40 €</b>
<b>65199P</b>	E L. 19,7 x l. 11,8 cm x H. 3,5 cm - 40 cl	x 12	<b>3,10 €</b>



<b>1002229P</b>	E L. 19,7 x l. 11,8 cm - 40 cl	x 12	<b>3,90 €</b>
-----------------	--------------------------------	------	---------------

## PORCELAINE

### Toulouse

En porcelaine culinaire.



Plat à gratin

**1010348**  
**1010347**

L. 22 x l. 22 x H. 6 cm  
L. 17,5 x l. 17,5 x H. 4,5 cm

x 1  
x 1

**P.U.HT**  
**19,75 €**  
**14,70 €**



Plat à lasagnes

**1010350**

L. 25 x l. 23 x H. 6 cm

x 1

**P.U.HT**  
**27,00 €**



Moule à tarte

**1010346**

Ø 27 x H. 4 cm

x 1

**P.U.HT**  
**19,75 €**

### Plat à lasagnes Londres

En porcelaine blanche.



**44070**

L. 19 x l. 13 x H. 4 cm - 35 cl

x 6

**P.U.HT**  
**7,90 €**

### Plat rond à oreilles

En porcelaine blanche très résistante.



**33098P**  
**363P**  
**362P**  
**361P**  
**37259P**

Ø 17,2 cm  
Ø 15,7 cm  
Ø 14,2 cm  
Ø 13,5 cm  
Ø 10 cm

x 12  
x 12  
x 12  
x 12  
x 12

**P.U.HT**  
**6,20 €**  
**4,90 €**  
**4,70 €**  
**4,50 €**  
**3,50 €**

### Plat ovale à oreilles

En porcelaine blanche très résistante.



**658P**  
**33091P**

L. 22,2 x l. 11,2 cm  
L. 18,4 x l. 9,8 cm

x 12  
x 12

**P.U.HT**  
**5,30 €**  
**4,00 €**

### Plat GN

En porcelaine crème. Format gastronomique compatible avec glissières, fours vitrines de tous types.



Plat GN 1/1

**61484P**

L. 53 x l. 32,5 x P. 6,5 cm

x 1

**P.U.HT**  
**60,50 €**



Plat GN 1/2

**61485P**

L. 32,5 x l. 26,5 x P. 6,5 cm

x 2

**P.U.HT**  
**30,25 €**



Plat GN 1/3

**61486**

L. 32,5 x l. 17,6 x P. 6,5 cm

x 3

**P.U.HT**  
**19,75 €**

### Moule à galantine

En porcelaine blanche. Sans couvercle.



**69770P**

L. 31 x l. 12 x  
H. 10,5 cm - 210 cl

x 2

**P.U.HT**  
**28,25 €**



**677**

L. 26 x l. 9 cm - 112 cl

x 2

**P.U.HT**  
**20,00 €**

## GRÈS

### Plat sabot

En grès émaillé brun.



**1002457P**  
**1002456P**  
**1002455P**  
**1002454P**  
**1002453P**

L. 27 x l. 18 cm - 127 cl  
L. 24,5 x l. 15 cm - 92 cl  
L. 21 x l. 14 cm - 78 cl  
L. 18 x l. 12 cm - 42 cl  
L. 16,6 x l. 10 cm - 35 cl

x 4  
x 6  
x 6  
x 6  
x 6

**P.U.HT**  
**10,70 €**  
**7,70 €**  
**7,00 €**  
**5,00 €**  
**4,20 €**

### Plat à cassoulet

En grès émaillé brun.



**1002460P**

Ø 18 x H. 6,5 cm - 105 cl

x 6

**P.U.HT**  
**6,20 €**

### Pot à cornichons

En grès.



**44054P**

Ø 12,5 x H. 14,5 cm - 100 cl

x 1

**P.U.HT**  
**10,90 €**

### Ecuelle bretonne

En grès émaillé.



**33122P**

Ø 14 cm - 50 cl

x 5

**P.U.HT**  
**4,40 €**

### Bolée à cidre

En grès émaillé brun.



**1002464P**

Ø 10,5 cm - 27 cl

x 12

**P.U.HT**  
**2,30 €**

### Marmelette

En grès émaillé brun.



**1002461P**

Ø 8,5 x H. 3,5 cm - 12,5 cl

x 12

**P.U.HT**  
**3,70 €**



## TAJINE

### Tajine

En terre cuite.



Brun

**1002091** Ø 17 x H. 7,5 cm  
**1013348** Ø 28 cm



x 4  
x 1

P.U.HT

**14,90 €**  
**30,25 €**



Noir

**1002092** Ø 17 x H. 7,5 cm



x 4

P.U.HT

**16,75 €**

## ESCARGOTS

### Plat à escargots Bistronome

En porcelaine blanche.



**69471P** Ø 14 x H. 3 cm - 6 trous x 6  
**69472P** Ø 21,5 x H. 3,5 cm - 12 trous x 6



x 6  
x 6

P.U.HT

**5,40 €**  
**10,90 €**



pro.mundi

### Pot à escargot

En grès beige.



**1002458P** Ø 3,5 cm - 2,5 cl



x 24

P.U.HT

**1,90 €**

### 1<sup>er</sup> PRIX

### Plat à escargots inox



**67649P** Ø 17,5 cm - 6 trous x 1  
**67650P** Ø 23 cm - 12 trous x 1



x 1  
x 1

P.U.HT

**4,00 €**  
**5,40 €**

### Poêlon à escargots

En grès brun.



**1002462P** Ø 13,5 x H. 3 cm - 6 trous x 6  
**1002463P** Ø 20 x H. 3 cm - 12 trous x 6



x 6  
x 6

P.U.HT

**6,00 €**  
**8,30 €**

### Pince à escargot

En inox. Conception avec ressort à forte résistance. Excellent maintien de l'escargot dans la pince.



**1002261P** L. 16 cm



x 1

P.U.HT

**6,40 €**



## SOUPIÈRES

nouveau !

### Soup Passion

En porcelaine.



**1013086** L. 27,5 x l. 17,3 x H. 6,8 cm x 2 **P.U.HT 13,10 €**  
**1013085** L. 23 x l. 13 x H. 5,2 cm x 2 **8,80 €**

### Léo

En porcelaine renforcée ultra blanche.



**69484P** Ø 9,5 x H. 7,5 cm - 45 cl x 12 **P.U.HT 5,90 €**  
**69483P** Ø 6,5 x H. 5 cm - 13 cl x 12 **2,60 €**  
**69482P** Ø 5 x H. 4 cm - 7,5 cl x 12 **2,00 €**

### Soupière

En grès émaillé gris.



**69463P** Ø 5,5 x H. 4,5 cm - 6 cl x 12 **P.U.HT 2,10 €**

### Tête de lion

En porcelaine blanche.



**49364P** E Ø 20 x H. 15 cm - 280 cl x 2 **P.U.HT 28,00 €**  
**49209P** Ø 13 x H. 10,5 cm - 74 cl x 6 **10,40 €**  
**49208P** Ø 12 x H. 9 cm - 56 cl x 4 **7,30 €**  
**41457P** Ø 11 x H. 8,5 cm - 45 cl x 6 **4,60 €**  
**49207P** Ø 9,5 x H. 7 cm - 25 cl x 12 **3,90 €**  
**49206P** Ø 7 x H. 6 cm - 16 cl x 12 **2,80 €**  
**53656P** Ø 5,5 x H. 6 cm - 9 cl x 12 **1,80 €**  
**58196P** Ø 5,5 x H. 4,5 cm - 6 cl x 12 **1,70 €**

## BOLS À BOUILLON

### Banquet

En porcelaine crème.



**A 63779P** Ø 10,5 cm - 30 cl x 12 **P.U.HT 4,70 €**  
**B 59205P** E Ø 10 cm - H. 5,5 cm - 30 cl x 6 **5,70 €**

### Brasserie

En porcelaine extra blanche.



**A 1006716P** 30 cl x 6 **P.U.HT 5,70 €**  
**B 1006717P** 30 cl x 6 **5,00 €**

## MOULES À SOUFLÉ

### Porcelaine

En porcelaine blanche.



**437** Ø 18,5 cm - 180 cl x 1 **P.U.HT 20,50 €**  
**436** Ø 10 cm - 35 cl x 12 **8,10 €**

### Prismo

En porcelaine blanche.



**1002177P** Ø 10 x H. 6,5 cm - 22 cl x 12 **P.U.HT 4,00 €**

## SAUCIÈRES

### Inox



**1001429P** 30 cl x 1 **P.U.HT 14,80 €**  
**1001435P** 15 cl x 1 **10,20 €**

### Porcelaine



**33275** 11 cl x 12 **P.U.HT 12,10 €**

### Brasserie

En porcelaine extra blanche.



**1006734P** H. 7,2 cm - 25 cl x 6 **P.U.HT 8,10 €**

### Saucière

En porcelaine blanche hôtelière.



**1001577P** E L. 12 cm - 4,5 cl x 24 **P.U.HT 2,80 €**

### Pot à sauce

En porcelaine blanche hôtelière.



**A 1001578P** E Ø 8 cm - 6,5 cl x 24 **P.U.HT 3,20 €**  
**B 1001579P** E L. 11 cm - 6,5 cl x 24 **2,50 €**

## BEURRIER

### Porcelaine

En porcelaine blanche robuste.



**69548P** Ø 7,5 cm - 4 cl - 40-45 g x 12 **P.U.HT 7,90 €**  
**69547P** Ø 6,5 cm - 2 cl - 20-25 g x 12 **5,40 €**

## COQUETIERS

nouveau !

### Coquetier

En métal



**1013537P** Ø 5 x H. 5 cm x 12 **P.U.HT 2,60 €**

### Banquet

En porcelaine crème.



**59231P** Ø 5,2 x H. 7,3 cm x 6 **P.U.HT 3,10 €**

### Brasserie

En porcelaine extra blanche.



**1006727P** Ø 6,5 x H. 5 cm x 12 **P.U.HT 3,50 €**

### Emotions

En porcelaine résistante.



Ø 5 x H. 6 cm  
**68403P** E Rouge x 12 **P.U.HT 3,80 €**  
**68402P** E Noir x 12 **3,80 €**  
**68401P** E Blanc x 12 **2,80 €**

### Cafett

En porcelaine blanche. Empilable.



**69416P** Ø 5 cm H. 4 cm x 12 **P.U.HT 3,10 €**

### Inox



**34350** Ø 5 x H. 5,2 cm x 6 **P.U.HT 1,90 €**



## RAVIERS

### Cafett

En porcelaine blanche. Empilable.



Compotier  
**65284P** E Ø 12 cm - 15 cl x 12 **P.U.HT**  
**2,00 €**



Compotier cafétéria  
**65283P** E Ø 13,5 cm - 25 cl x 12 **P.U.HT**  
**2,60 €**



Compotier cafétéria  
**65282P** E Ø 15,5 cm - 37 cl x 12 **P.U.HT**  
**2,80 €**



Coupelle  
**69415P** E Ø 8 cm - 10 cl x 12 **P.U.HT**  
**2,70 €**



Coupelle cafétéria  
**69413P** E Ø 13 cm x 12 **P.U.HT**  
**2,80 €**  
**69414P** E Ø 10 cm x 12 **1,60 €**



Ravier carré  
**59248P** E L. 11 x l. 11 x H. 3,5 cm - 20 cl x 12 **P.U.HT**  
**2,00 €**



Ravier rectangle  
**424P** E L. 14,9 x l. 9,5 x H. 3,6 cm - 26 cl x 12 **P.U.HT**  
**2,00 €**

### Ravier

En verre sodocalcique.



**59685P** E L. 14 x l. 9 x H. 3,5 cm x 3 **P.U.HT**  
**2,20 €**

ARCOROC

## RAMEQUINS

### Bistronome

En grès émaillé.



Ramequin plissé gris  
**69474P** Ø 10,5 x H. 5 cm - 19 cl x 12 **P.U.HT**  
**2,90 €**  
**69473P** Ø 8,5 x H. 4,5 cm - 14 cl x 12 **2,50 €**



Ramequin plissé blanc  
**396P** E Ø 10,5 x H. 5 cm - 19 cl x 12 **P.U.HT**  
**2,90 €**  
**395P** E Ø 8,5 x H. 4,5 cm - 14 cl x 12 **2,50 €**  
**53654P** E Ø 7 cm - 7 cl x 12 **1,40 €**

### Cookware

En borosilicate.

**PYREX**



**64236P** Ø 10 cm - 20 cl x 24 **P.U.HT**  
**2,30 €**

### nouveau !

### Ovenchef

En verre trempé.



**1011739P** Ø 10 x H. 5 cm - 24 cl x 4 **P.U.HT**  
**0,78 €**

### Lyon

En verre trempé.



**394P** E Ø 8,5 x H. 4,1 cm - 10 cl x 4 **P.U.HT**  
**0,68 €**

### Inox

En inox.



**398** Ø 9,5 cm - 15 cl x 1 **P.U.HT**  
**6,60 €**

## MOULES À SOUFLÉ



### Porcelaine

En porcelaine blanche.



**437** Ø 18,5 cm - 180 cl  
**436** Ø 10 cm - 35 cl

x 1  
x 12

**P.U.HT**  
**20,50 €**  
**8,10 €**

### Prismo

En porcelaine blanche.



**1002177P** Ø 10 x H. 6,5 cm - 22 cl

x 12

**P.U.HT**  
**4,00 €**



## ASSIETTES CATALANES



REVOL Made in France

### Londres

En porcelaine blanche.



**41464** Ø 14 x H. 2,5 cm - 11 cl

x 6

**P.U.HT**  
**5,20 €**

### Prismo

En porcelaine blanche.



**1002176P** Ø 14 cm - 28 cl

x 12

**P.U.HT**  
**3,90 €**



### Cafett

En porcelaine blanche.



**41462P** Ø 14 x H. 3 cm  
**69452P** Ø 8 x H. 2,5 cm

x 6  
x 12

**P.U.HT**  
**5,70 €**  
**1,60 €**

## RAMEQUINS MÉLAMINE

### Mélamine



**A 1008158P** Ø 7,14 x H. 3,81 cm - 5,9 cl  
**A 1008156P** Ø 7,94 x H. 4,29 cm - 9 cl  
**B 1008157P** Ø 7,14 x H. 3,81 cm - 5,9 cl

x 12  
x 12  
x 12

**P.U.HT**  
**0,91 €**  
**1,20 €**  
**0,95 €**

### Dalebrook



Ø 6,4 cm - 12 cl  
**69091P** Blanc  
**69092P** Noir

x 24  
x 24

**P.U.HT**  
**2,50 €**  
**2,50 €**

## 1<sup>er</sup> PRIX

En terre cuite.



Noir  
**1002089P** Ø 11,5 x H. 2,5 cm

x 24

**P.U.HT**  
**2,30 €**



Rouge  
**1002090P** Ø 11,5 x H. 2,5 cm

x 24

**P.U.HT**  
**2,30 €**



Brun  
**50440P** Ø 14 cm  
**50439P** Ø 11,5 cm  
**50438P** Ø 8 cm  
**1002088P** Ø 6 cm

x 1  
x 24  
x 24  
x 24

**P.U.HT**  
**1,80 €**  
**1,30 €**  
**0,96 €**  
**0,84 €**





## M'Minis

MAUVIEL 1830.

Idéal pour les petits accompagnements ou sauces à rajouter sur table. Ludique et amusant par le style, ces petits ustensiles de cuisson, en cuivre et inox, n'en sont pas moins conçus avec la même démarche qualité que le reste de la gamme Mauviel. A utiliser sans modération, cuisiner dans ces petits récipients sera un réel plaisir.

### Premium

#### Cuivre



Casserolette  
**1006203** Ø 9 x H. 4,5 cm - 30 cl x 1 **P.U.HT**  
**32,25 €**



Casserolette  
**1006202** Ø 7 x H. 5 cm - 20 cl x 1 **P.U.HT**  
**30,00 €**



Mini cocotte ovale avec couvercle  
**1006205** L. 12 x H. 4,5 cm - 30 cl x 1 **P.U.HT**  
**49,25 €**



Mini sauteuse évasée  
**1006208** Ø 12 x H. 8 cm - 45 cl x 1 **P.U.HT**  
**106,00 €**

#### Inox



Casserolette  
**1006201** Ø 9 x H. 4,5 cm - 30 cl x 1 **P.U.HT**  
**22,00 €**



Mini poêle  
**1006207** Ø 12 x H. 2,5 cm - 26 cl x 1 **P.U.HT**  
**27,25 €**



Mini cocotte ovale avec couvercle  
**1006206** L. 12 x H. 4,5 cm - 30 cl x 1 **P.U.HT**  
**33,75 €**



Mini cocotte ronde avec couvercle  
**1006204** Ø 9 x H. 4,5 cm - 30 cl x 1 **P.U.HT**  
**30,25 €**







HYPINOX

## Hypinox



En inox.



**Mini poêlon**  
**1006243P** Ø 14 x H. 4 cm x 1 **P.U.HT 24,50 €**  
**1006242P** Ø 12 x H. 3,5 cm x 1 **22,00 €**



**Mini poêle**  
**1005342P** Ø 12,5 x H. 3,5 cm x 6 **P.U.HT 12,10 €**



**Mini casserole**  
**1005341P** Ø 9 x H. 6 cm x 6 **P.U.HT 10,20 €**



**Mini cocotte ronde sans couvercle**  
**1005338P** Ø 10,2 x H. 6 cm x 6 **P.U.HT 12,10 €**

**Couvercle**  
**1005340P** Ø 11 cm x 6 **P.U.HT 3,40 €**



## Mini cocotte Cooko



Mini cocottes en fonte émaillée. Cooko passe au four jusqu'à 200°C pour un usage du four à la table.



**Mini cocotte ronde**  
**70268P** Ø 14 x H. 6,5 cm - 75 cl x 1 **P.U.HT 30,75 €**  
**69729P** Ø 10 x H. 4,8 cm - 25 cl x 1 **20,50 €**



**Mini cocotte ovale**  
**70270P** L. 17 x H. 4,8 cm - 75 cl x 1 **P.U.HT 33,25 €**  
**69730P** L. 12 x H. 4,8 cm - 30 cl x 1 **21,75 €**

## Mini plat



En fonte noir mat.



**Mini plat rond**  
**70304P** Ø 20 x H. 3 cm x 1 **P.U.HT 42,50 €**  
**70301P** Ø 16 x H. 3 cm x 1 **27,50 €**



**Mini plat ovale**  
**70302P** L. 15 x l. 10 x H. 3 cm x 1 **P.U.HT 27,50 €**



## Plat en fonte



En fonte émaillée.



**Poêle à blinis**  
**50728** Ø 12 cm - 15 cl x 6 **P.U.HT 51,00 €**



**Mini wok**  
**51059P** Ø 16 x H. 11,5 cm - 65 cl x 2 **P.U.HT 85,00 €**



**Mini cocotte**  
**50725** Ø 10 x H. 7 cm - 25 cl x 1 **P.U.HT 47,25 €**  
**Set de 6 mini cocottes**  
**1005612P** Ø 10 x H. 7 cm - 25 cl x 1 **180,00 €**



Cocottes en fonte p 408

MINIS INOX / FONTE



ART DE LA TABLE

## MINI DESIGN

### Coupelle Playtime

En porcelaine ultra-blanche renforcée.



✓ **1001388P** L. 7,5 x l. 7,5 x H. 3,5 cm - 6 cl x 24 **P.U. HT 1,70 €**

### Tarte Playtime

En porcelaine ultra-blanche renforcée.



**68162P** Ø 8 x H. 2 cm - 4 cl x 12 **P.U. HT 1,80 €**

### Goutte Playtime

En porcelaine ultra-blanche renforcée.



**68156P** Ø 10 x H. 4 cm - 10 cl x 12 **P.U. HT 2,20 €**

### Assiette Gourmet Playtime

En porcelaine ultra-blanche renforcée.



**1002173P** Ø 10 cm - 2 cl x 12 **P.U. HT 1,60 €**

### Casserole

En porcelaine blanche.



✓ **62092P** Ø 6 cm - 2,5 cl x 12 **P.U. HT 2,30 €**

### Casserole Playtime

En grès émaillé gris.



**69461P** Ø 6 x H. 3 cm - 3 cl x 12 **P.U. HT 1,90 €**

### Tajine Playtime

En porcelaine ultra-blanche renforcée.



**68159P** Ø 7 x H. 7 cm - 3 cl x 12 **P.U. HT 2,80 €**

### Plat carré Playtime

En porcelaine ultra-blanche renforcée.



**68164P** L. 7 x l. 7 x H. 2,5 cm - 5 cl x 12 **P.U. HT 1,80 €**

### Bol japonais Playtime

En porcelaine ultra-blanche renforcée.



**68158P** Ø 8 x H. 3 cm - 7 cl x 12 **P.U. HT 2,50 €**

### Cuillère papillon Playtime

En porcelaine ultra-blanche renforcée.



**1002341P** L. 10 cm x 24 **P.U. HT 0,81 €**

### Plat à oreilles

En porcelaine blanche.



✓ **58198P** Ø 6,5 cm - 3 cl x 12 **P.U. HT 1,70 €**

### Plat à oreilles

En grès émaillé gris.



**69462P** Ø 6,5 x H. 2,5 cm - 3 cl x 12 **P.U. HT 2,20 €**



### Cube Playtime

En porcelaine ultra-blanche renforcée.



✓ **68161P** L. 5,2 x l. 5,2 x H. 5,7 cm - 7 cl x 12 **P.U. HT 2,70 €**

### Soupière

En porcelaine blanche.



**58196P** Ø 5,5 x H. 4,5 cm - 6 cl x 12 **P.U. HT 1,70 €**

### Soupière

En grès émaillé gris.



**69463P** Ø 5,5 x H. 4,5 cm - 6 cl x 12 **P.U. HT 2,10 €**



## MINI INCONTOURNABLE

### Gobelet Allspice

En porcelaine crème.



**63281P** Ø 5 x H. 4 cm - 7 cl

x 12

**P.U.HT**  
**3,90 €**

### Coupelle carrée Allspice

En porcelaine crème.



**63413P** L. 6 x l. 6 x H. 3 cm - 6 cl

x 6

**P.U.HT**  
**4,60 €**

### Bol Allspice

En porcelaine crème.



**63269P** Ø 8 x H. 4 cm - 8 cl

x 12

**P.U.HT**  
**3,80 €**

### Coupelle à sauce

En porcelaine blanche.



**33277** Ø 7 cm

x 24

**P.U.HT**  
**3,60 €**

### Pot

En porcelaine blanche.



**59099P** Ø 6 x H. 5,5 cm - 7 cl  
**59098P** Ø 6 x H. 4,5 cm - 5 cl

x 12  
x 24

**P.U.HT**  
**4,40 €**  
**3,30 €**

### Coupelle carrée

En porcelaine blanche.



**56471P** L. 8 x l. 8 x H. 2,5 cm - 4 cl

x 12

**P.U.HT**  
**1,80 €**

### Ravier Allspice

En porcelaine crème.



**63274P** L. 7 x l. 7 x H. 3 cm

x 6

**P.U.HT**  
**4,50 €**

### Coupelle Allspice

En porcelaine crème.



**63268P** Ø 7,5 x H. 5,5 cm - 18 cl

x 12

**P.U.HT**  
**4,10 €**

### Coupelle Curcuma Allspice

En porcelaine crème.



**62604P** L. 8 x l. 8 cm

x 12

**P.U.HT**  
**5,20 €**

### Pot à jus

En porcelaine blanche.



**41478** 8 cl

x 12

**P.U.HT**  
**5,40 €**

### Marmite à jus

En porcelaine blanche.



**62091P** Ø 5 cm - 10 cl

x 12

**P.U.HT**  
**3,40 €**

### Cocotte ronde

En porcelaine blanche.



**69480P** Ø 7 x H. 3 cm - 7 cl

x 12

**P.U.HT**  
**5,50 €**

### Cube Allspice

En porcelaine crème.



**62607P** L. 5 x l. 5 x H. 5,5 cm - 9 cl  
**63341P** L. 5 x l. 5 x H. 4 cm - 6 cl

x 12  
x 12

**P.U.HT**  
**5,00 €**  
**4,40 €**

### Gobelet Basil Allspice

En porcelaine crème.



**61405P** 9 cl

x 12

**P.U.HT**  
**4,00 €**

### Cylindre tronqué

En porcelaine blanche.



**55282** Ø 5 x H. 7 cm - 7 cl

x 12

**P.U.HT**  
**4,80 €**

### Pot Elypse

En porcelaine blanche.



**59100P** L. 6,5 x l. 4,5 x H. 6,5 cm - 7 cl

x 12

**P.U.HT**  
**2,50 €**

### Coupelle ronde

En porcelaine blanche.



**56470P** Ø 10,5 x H. 5 cm - 13 cl

x 12

**P.U.HT**  
**2,40 €**

### Cuillère amuse-bouche

En porcelaine blanche.



**56472P** L. 12 cm

x 24

**P.U.HT**  
**0,72 €**

### nouveau ! Pot conique



**1013643P** Ø 10 x H. 8,5 cm - 28 cl  
**1013644P** Ø 8,5 x H. 7,5 cm - 20 cl

x 12  
x 12

**P.U.HT**  
**5,40 €**  
**5,10 €**



# Durobor®

MADE IN BELGIUM



Durobor® a toujours mis un soin particulier à développer des modèles aux designs originaux tout en répondant aux exigences professionnelles. A travers sa gamme de verrines, Durobor® propose une riche déclinaison de formes élégantes et variées pour une mise en valeur optimale de vos préparations. Découvrez quelques-unes de ses créations :

1. Milord : coupe effet retro par sa structure à facettes - 2. Atoll : véritable écrin de douceur - 3. Galleo : verrine contemporaine à la base originale d'inspiration minérale - 4. Gem : verrine effet vintage grâce à sa structure toute particulière d'enchaînement de petites pyramides en relief.

# MONOPORTION

## Fido

En verre sodocalcique.



1005397P L. 10,6 x H. 9,8 cm - 50 cl x 6

P.U.HT  
2,80 €



69311P Ø 8,33 x H. 8,4 cm - 20 cl x 6

P.U.HT  
2,90 €

## Quattro Stagioni

En verre sodocalcique. Fermeture à capsule.



1013164P Ø 8,9 x H. 10,8 cm - 32 cl x 12

P.U.HT  
1,70 €

## Swing

En verre. Fermeture hermétique.



68315P Ø 5,5 x H. 20 cm - 25 cl x 28

P.U.HT  
2,00 €

## Fluid

En verre sodocalcique.

ARCOROC



1008354P E Ø 7,1 x H. 13,5 cm - 25 cl x 12

P.U.HT  
2,50 €

## Twice

En verre borosilicate double paroi.



69590P Ø 8,4 x H. 11,3 cm - 23 cl x 6

P.U.HT  
7,60 €

## Amétista

En verre borosilicate double paroi.

Luigi Bernicchi  
ITALY



1013240P Ø 9,3 x H. 8,6 cm - 22 cl x 2

P.U.HT  
4,90 €

## Galléo

En verre sodocalcique.



1013399P Ø 10 x H. 6 cm - 25 cl x 6

P.U.HT  
1,80 €

## Bambou

En verre sodocalcique.



69667P Ø 9,1 x H. 7 cm - 26 cl x 6

P.U.HT  
1,90 €

## Vertigo

En verre sodocalcique.



65313P Ø 11,6 x H. 6,4 cm - 35 cl x 4  
67254P Ø 9,9 x H. 5,6 cm - 22 cl x 6

P.U.HT  
3,10 €  
2,10 €

## Ypsilon

En verre sodocalcique.



1013163P Ø 9,2 x H. 10,7 cm - 24,5 cl x 6

P.U.HT  
1,70 €

## Arôme

En verre trempé.



69315P Ø 8,2 x H. 7,7 cm - 19 cl x 6

P.U.HT  
1,20 €

## Atoll

En verre sodocalcique.



64375P Ø 9 x H. 7 cm - 25 cl x 6

P.U.HT  
2,40 €

## Eskale

En verre trempé.

ARCOROC EXTRA RESISTANT



1008021P E Ø 9 x H. 8,7 cm - 31 cl x 6

P.U.HT  
1,20 €

## Pinta

En verre trempé.

ARCOROC EXTRA RESISTANT



68528P Ø 8,5 x H. 8,9 cm - 36 cl x 6

P.U.HT  
1,00 €

## Chiquito

En verre trempé.

ARCOROC EXTRA RESISTANT



1002594P E Ø 8,2 x H. 5,9 cm - 23 cl x 24

P.U.HT  
0,61 €



## MÉDIUM

nouveau !

### Quattro stagioni

En verre sodocalcique. Capsule hermétique.



1013162P Ø 8,9 x H. 8,6 cm - 20 cl x 12

P.U.HT  
1,70 €

### Gem

En verre sodocalcique.



1011175P Ø 7,1 x H. 6,5 cm - 12 cl x 6

P.U.HT  
1,40 €

### Fido

En verre sodocalcique. Fermeture hermétique.



69668P Ø 8,3 x H. 7,1 cm - 12,5 cl x 6

P.U.HT  
2,70 €

### Verrine hermétique

En verre sodocalcique.



69597P Ø 6,4 x H. 8,5 cm - 12 cl x 6

P.U.HT  
2,60 €

### Swing

En verre sodocalcique.



1008056P Ø 5,9 x H. 13,4 cm - 12,5 cl x 20

P.U.HT  
1,80 €

### Fluid

En verre sodocalcique.

ARCOROC



1008353P Ø 6 x H. 11,3 cm - 12,5 cl x 12

P.U.HT  
1,50 €

nouveau !

### Galléo

En verre sodocalcique.



1013149P Ø 8,1 x H. 4,9 cm - 12,5 cl x 6

P.U.HT  
1,20 €

### Eskale

En verre trempé.

ARCOROC EXTRA RESISTANT



1008022P Ø 7,7 x H. 7,8 cm - 18 cl x 6

P.U.HT  
0,92 €

### Disco

En verre sodocalcique.



68262P Ø 6,9 x H. 7 cm - 15 cl x 6

P.U.HT  
1,60 €

### Atoll

En verre sodocalcique.



59539P Ø 7,2 x H. 5,7 cm - 11 cl x 6

P.U.HT  
1,70 €

nouveau !

### Amétista

En verre borosilicate double paroi.

Lupi Bormioli ITALY



A 1013241P Ø 6,3 x H. 6,3 cm - 11,5 cl x 2  
B 1013242P Ø 6 x H. 6,7 cm - 11 cl x 2

P.U.HT  
3,60 €  
3,70 €

### Carat

En verre sodocalcique.



63063P Ø 6,7 x H. 5,8 cm - 12 cl x 6

P.U.HT  
1,60 €

### Equinox

En verre sodocalcique.



57115P Ø 7,5 x H. 4,9 cm - 11 cl x 12

P.U.HT  
1,40 €

### Ypsilon

En verre sodocalcique.



64530P Ø 7,7 x H. 9,5 cm - 15 cl x 6

P.U.HT  
1,50 €

### Islande

En verre sodocalcique.

ARCOROC



51117P Ø 5,1 x H. 8,7 cm - 10 cl x 24

P.U.HT  
0,69 €

### Kube

En verre sodocalcique.

La Rochère



65314P L. 5,5 x l. 5,5 x H. 6,8 cm 10 cl x 6

P.U.HT  
1,80 €



## MINI

### Quartz

En verre sodocalcique.



59542P

Ø 5,6 x H. 6,5 cm - 7 cl



P.U. HT  
1,40 €

### Eskale

En verre trempé.



1011429P

Ø 6,2 x H. 6,4 cm - 9 cl



P.U. HT  
0,94 €

### Concerto

En verre sodocalcique ultra brillant.



1005527P

Ø 5,8 x H. 7,2 cm - 9 cl



P.U. HT  
1,40 €

### Diamond

En verre sodocalcique.



1007475P

Ø 5,9 x H. 7,1 cm - 8 cl



P.U. HT  
0,54 €



### Granity

En verre trempé.



1005497P

Ø 5 x H. 5,7 cm - 4,5 cl



P.U. HT  
0,80 €

### Ellipse

En verre sodocalcique.



57113P

Ø 6,5 x H. 6,5 cm - 9 cl



P.U. HT  
1,50 €

### Bubble

En verre sodocalcique.



1001384P

Ø 7,7 x H. 5,7 cm - 5 cl



P.U. HT  
1,60 €

### Verrine

En verre sodocalcique.



69596P

Ø 4,5 x H. 8,5 cm - 6,3 cl



P.U. HT  
2,10 €

### Disco

En verre sodocalcique.



57111P

Ø 4,5 x H. 6,7 cm - 5 cl



P.U. HT  
1,10 €

### Shetland

En verre sodocalcique.



60095P

Ø 6 x H. 7,8 cm - 9 cl



P.U. HT  
0,93 €

# GRANITY

MIGNARDISES VERRE



ART DE LA TABLE

## MINI

### Stack up

ARCOROC  

En verre trempé.



**1005499P** Ø 5 x H. 5,8 cm - 4,5 cl x 12 **P.U.HT 0,76 €**

### Dublino

En verre trempé.



**51601P** Ø 4,5 x H. 7 cm - 3,4 cl x 6 **P.U.HT 0,90 €**

### Islande

ARCOROC

En verre sodocalcique.



**2020P** Ø 3,8 x H. 10,5 cm - 6 cl x 12 **P.U.HT 0,55 €**

### Gigogne

En verre trempé.



**69334P** E Ø 5,8 x H. 6,1 cm - 9 cl x 6 **P.U.HT 0,39 €**

### Gin

ARCOROC

En verre sodocalcique.



**50006P** Ø 4,2 x H. 5,2 cm - 3 cl x 24 **P.U.HT 0,48 €**

### Salto

ARCOROC

En verre sodocalcique.



**62727P** Ø 4,8 x H. 6,6 cm - 6 cl x 12 **P.U.HT 0,83 €**

1<sup>er</sup> PRIX

### Pili Pili

En verre sodocalcique.



**67704P** E Ø 5,1 x H. 6 cm - 6,2 cl x 48 **P.U.HT 1,10 €**

### Pom pom

En verre sodocalcique.



**67707P** E Ø 5 x H. 6 cm - 5 cl x 48 **P.U.HT 1,10 €**

### Buzz

En verre sodocalcique.



**67705P** E Ø 4,5 x H. 6,8 cm - 8,4 cl x 48 **P.U.HT 1,10 €**

## ACCESSOIRES

### Hédonie

INOX 18/10

Finition poli-miroir. Epaisseur 3,5 mm.



Cuillère-fourchette **1004277P** L. 18,7 cm x 12 **P.U.HT 5,10 €**

### Fourchette

PS cristal.



Sachet de 250 **64525P** L. 10 cm x 20 **P.U.HT 5,60 €**

### Hédonie

INOX 18/10

En inox. Finition poli standard. Epaisseur 1,2 mm.



Cuillère - fourchette **1006003P** L. 10,8 cm x 12 **P.U.HT 0,79 €**

### Pique bois



2 pointes Paquet de 1000 **1002343P** L. 8 cm. x 1 **P.U.HT 3,30 €**

Autres piques voir page 315

### Wave

INOX 18/10

Finition poli-miroir. Epaisseur 2,2 mm.



Cuillère à moka **69533P** L. 11 cm x 12 **P.U.HT 1,40 €**

### Pique

En PS.



Paquet de 100 **1002347P** L. 9 cm. x 1 **P.U.HT 1,60 €**



## Allspice

En porcelaine crème extra-résistante.  
3 empreintes Ø 5, 6,7 et 9 cm.



Plateau gourmand Wasabi  
**68572** L. 24 x l. 14 cm



x 6

**P.U.HT**  
**17,75 €**

## Giro

En porcelaine crème.



Sous-tasse  
à espresso / déjeuner gourmand  
**1006492P** L. 29 x l. 16 cm



x 12

**P.U.HT**  
**9,50 €**

## Froissé

En porcelaine blanche.



Plateau gourmand  
pour espresso/cappuccino  
**64603P** L. 26 x l. 18 cm



x 6

**P.U.HT**  
**12,80 €**

## Prismo

En porcelaine blanche.  
2 empreintes pour petits et grands gobelets Prismo.



pro.mundi



Gobelets Prismo  
voir page 129



Plateau gourmand

**1002178P** L. 23 x l. 9 cm

x 1

**4,10 €**

## Edina

En porcelaine blanche.



pro.mundi



Sous-tasse à café ou thé gourmand

**1002179P** L. 21 x l. 13 cm



x 12

**P.U.HT**  
**4,30 €**

## Brasserie

En porcelaine extra blanche.



Ariane



Sous tasse à café/thé gourmand

**1006711P** Ø 17 cm  
**1006712** Ø 19 cm  
**1006713P** Ø 21 cm

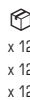

x 12  
x 12  
x 12

**P.U.HT**  
**3,30 €**  
**3,80 €**  
**4,40 €**

## Basalt

En porcelaine.



REVOL



Sous-tasse

**66321P** L. 25 x l. 12 cm - 1 empreinte x 6



x 6

**P.U.HT**  
**9,60 €**



Sous-tasse café/thé gourmand

**1002541P** L. 29 x l. 13,4 cm



x 6

**P.U.HT**  
**11,70 €**

## Ardoise

En ardoise naturelle.



Plateau café gourmand - Lot de 2  
**1002097P** L. 25 x l. 12 cm



x 3

**P.U.HT**  
**18,25 €**





NEWPORT

nouveau !

Newport

 DEGRENNE  
 INOX 18/10

Verseuse avec couvercle

<b>1013217</b>	70 cl	x 1	<b>P.U. HT</b>
<b>1013218</b>	35 cl	x 1	<b>86,00 €</b>



Crémier

<b>1013220</b>	15 cl	x 1	<b>P.U. HT</b>
			<b>41,50 €</b>



Sucrier

<b>1013219</b>	35 cl	x 1	<b>P.U. HT</b>
			<b>47,25 €</b>



DOLCE

Dolce

En inox poli miroir.

INOX 18/10



Cafetière avec couvercle

<b>69357P</b>	H. 13 cm - 60 cl	x 1	<b>P.U. HT</b>
			<b>21,00 €</b>

Théière avec couvercle

<b>1001364P</b>	H. 13 cm - 60 cl	x 1	<b>P.U. HT</b>
<b>65138P</b>	H. 9,5 cm - 35 cl	x 1	<b>19,25 €</b>
			<b>16,50 €</b>



Pot à lait

<b>69306P</b>	60 cl	x 1	<b>P.U. HT</b>
<b>69309P</b>	35 cl	x 1	<b>18,75 €</b>
<b>69305P</b>	15 cl	x 1	<b>12,60 €</b>
			<b>10,00 €</b>

Porte-cuillère



Porte cuillère

<b>61458P</b>	Ø 8,5 x H. 10 cm	x 1	<b>P.U. HT</b>
			<b>12,10 €</b>

Cuillère à moka

<b>69202P</b>	Boîte de 120	x 1	<b>P.U. HT</b>
			<b>32,50 €</b>

Boule à thé

En inox.

**52740P** 4 cm

x 4	<b>P.U. HT</b>
	<b>5,40 €</b>

Sucrier boule

En Inox.

**67664P** Ø 14 x H. 13 cm

x 1	<b>P.U. HT</b>
	<b>21,75 €</b>

Sucre

S'utilise à chaud et à froid pour la pâtisserie, les cocktails et la restauration.

ZUK



480 buchettes de 4 g	<b>P.U. HT</b>
<b>64791P</b> Nature	x 1 <b>32,75 €</b>

380 berlingots de 4 g	<b>P.U. HT</b>
<b>64792P</b> Nature	x 1 <b>32,75 €</b>
<b>64789P</b> Coloré	x 1 <b>37,00 €</b>

	x 1	
--	-----	--

	x 1	
--	-----	--

	x 1	
--	-----	--



FROISSÉ

## Froissé

Le gobelet en plastique ... froissé puis réalisé en porcelaine culinaire.



Rouge piment

**64601**

Gobelet expresso 8 cl

x 6

**P.U.HT**  
**6,40 €**



Noir Satiné

**70006**  
**70008**  
**64600P**

Gobelet déjeuner 33 cl  
Gobelet cappuccino 18 cl  
Gobelet expresso 8 cl

x 6  
x 6  
x 6

**P.U.HT**  
**10,70 €**  
**9,40 €**  
**6,40 €**



Blanc

**68664**  
**66030**  
**59504P**

Gobelet déjeuner 33 cl  
Gobelet cappuccino 18 cl  
Gobelet expresso 8 cl

x 6  
x 6  
x 6

**P.U.HT**  
**10,40 €**  
**9,20 €**  
**5,90 €**



PRISMO

## Prismo

En grès.



Gobelet Ø 8,5 x H. 9 cm - 20 cl

<b>1002228P</b>	Rouge	x 12	<b>3,40 €</b>
<b>1002224P</b>	Taupe	x 12	<b>3,40 €</b>
<b>1002223P</b>	Blanc	x 12	<b>3,40 €</b>
<b>1002227P</b>	Noir	x 12	<b>3,40 €</b>

Gobelet Ø 6 cm x H. 6,5 cm - 10 cl

<b>1002220P</b>	Rouge	x 12	<b>2,30 €</b>
<b>1002221P</b>	Taupe	x 12	<b>2,30 €</b>
<b>1002217P</b>	Blanc	x 12	<b>2,30 €</b>
<b>1002218P</b>	Noir	x 12	<b>2,30 €</b>



ÉMOTIONS

## Émotions

En porcelaine.



Noir

<b>68373P</b>	E Tasse à expresso 9 cl	x 6	<b>3,20 €</b>
<b>68407P</b>	E Sous-tasse à expresso Ø 12 cm	x 6	<b>2,40 €</b>
<b>68378P</b>	E Tasse à cappuccino/thé 20 cl	x 6	<b>4,70 €</b>
<b>68379P</b>	E Sous-tasse à cappuccino/thé Ø 14 cm	x 6	<b>3,50 €</b>
<b>68394P</b>	E Mug 32 cl	x 6	<b>4,80 €</b>
<b>68397P</b>	E Bol Ø 14 cm - 63 cl	x 6	<b>6,40 €</b>

Coquetiers assortis voir page 115



Rouge

<b>68374P</b>	E Tasse à expresso 9 cl	x 6	<b>3,20 €</b>
<b>68375P</b>	E Sous-tasse à expresso Ø 12 cm	x 6	<b>2,40 €</b>
<b>68380P</b>	E Tasse à cappuccino/thé 20 cl	x 6	<b>4,70 €</b>
<b>68381P</b>	E Sous-tasse à cappuccino/thé Ø 14 cm	x 6	<b>3,50 €</b>
<b>68395P</b>	E Mug 32 cl	x 6	<b>4,80 €</b>
<b>68399P</b>	E Bol Ø 14 cm - 63 cl	x 6	<b>6,40 €</b>

nouveau !



Gris

<b>1007262P</b>	E Tasse à expresso 9 cl	x 6	<b>3,20 €</b>
<b>1007311P</b>	E Sous-tasse à expresso Ø 12 cm	x 6	<b>2,40 €</b>
<b>1007320P</b>	E Tasse à cappuccino/thé 20 cl	x 6	<b>4,70 €</b>
<b>1007321P</b>	E Sous-tasse à cappuccino/thé Ø 14 cm	x 6	<b>3,50 €</b>



Ivoire

<b>1007322P</b>	E Tasse à expresso 9 cl	x 6	<b>3,20 €</b>
<b>1007323P</b>	E Sous-tasse à expresso Ø 12 cm	x 6	<b>2,40 €</b>
<b>1007324P</b>	E Tasse à cappuccino/thé 20 cl	x 6	<b>4,70 €</b>
<b>1007321P</b>	E Sous-tasse à cappuccino/thé Ø 14 cm	x 6	<b>3,50 €</b>



## BARISTA

## Premium

## Nectar

En porcelaine Maxima.

Tasse à espresso  
1011497 8 cl

x 24

P.U. HT  
4,50 €Tasse à thé  
1011501 22 cl

x 24

P.U. HT  
5,60 €

## Sous-tasse

1011498 Espresso Ø 12 cm  
1011500 Thé Ø 16 cm

x 24

P.U. HT  
3,20 €  
3,80 €Théière avec couvercle en acier  
1011502 40 cl

x 8

P.U. HT  
19,00 €

## Cuillère

1011508 L. 11 cm



x 36

P.U. HT  
2,30 €

## Barista

En porcelaine crème.

Tasse à espresso  
1005432P

x 12

P.U. HT  
2,80 €Tasse à thé  
1005433P 20 cl

x 12

P.U. HT  
4,30 €Tasse à déjeuner  
1005434 37 cl

x 12

P.U. HT  
5,00 €

## Sous-tasse

64580P Espresso Ø 13 cm  
68523P Thé/déjeuner Ø 15 cm

x 12

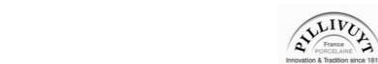
P.U. HT  
2,40 €  
3,10 €

## Flûto

En porcelaine blanche résistante.

Tasse à ristretto  
1006107 5 cl

x 12

P.U. HT  
4,00 €

## Sous-tasse à ristretto

1007367 Ø 11,5 cm



x 12

P.U. HT  
3,00 €

## Tasse à lungo

1007364 18 cl



x 12

P.U. HT  
5,80 €

## Sous-tasse à lungo

1007365 Ø 14,9 cm



x 12

P.U. HT  
3,70 €



## Emotions



En porcelaine hôtelière blanche très résistante.



Tasse à espresso  **P.U.HT**  
**68371P** E 9 cl x 6 **2,30 €**  
 Sous-tasse à espresso  
**68372P** E Ø 12 cm x 6 **1,60 €**



Tasse à cappuccino/thé  **P.U.HT**  
**68376P** E 20 cl x 6 **3,50 €**  
 Sous-tasse à cappuccino/thé  
**68377P** E Ø 14 cm x 6 **2,40 €**



Tasse à déjeuner  **P.U.HT**  
**68385P** E 30 cl x 6 **4,40 €**  
 Sous-tasse à déjeuner  
**68386P** E Ø 16 cm x 6 **3,10 €**

## Slim'O

En porcelaine hôtelière blanche très résistante.



Tasse à espresso forme haute  **P.U.HT**  
**71225P** 8 cl x 12 **3,80 €**



Tasse à cappuccino  **P.U.HT**  
**71230P** 20 cl x 12 **4,10 €**



Tasse à espresso forme basse  **P.U.HT**  
**71226P** 9 cl x 12 **2,70 €**



Tasse à déjeuner  **P.U.HT**  
**71231P** 30 cl x 12 **5,40 €**  
 Sous-tasse à cappuccino/déjeuner  
**71232P** Ø 15 cm x 12 **3,60 €**



Sous-tasse à espresso FB & FH  **P.U.HT**  
**71227P** Ø 12 cm x 12 **2,40 €**



Mug  **P.U.HT**  
**71233P** 27 cl x 12 **4,80 €**



Mug  **P.U.HT**  
**68393P** E 32 cl x 6 **3,50 €**



Tasse à thé  **P.U.HT**  
**71228P** 15 cl x 12 **3,80 €**  
 Sous-tasse à thé  
**71229P** Ø 13 cm x 12 **3,20 €**



Théière avec couvercle  **P.U.HT**  
**71234P** 40 cl x 2 **11,20 €**



Bol  **P.U.HT**  
**68398P** E Ø 14cm - 63 cl x 6 **5,20 €**



## Paula

En porcelaine blanche.

**Tasse à café**  
60457P 7 cl x 12**P.U.HT**  
2,60 €**Tasse à thé**  
60458P 15 cl x 12**P.U.HT**  
4,20 €**Sous-tasse à café**  
60454P Ø 12 cm x 12**P.U.HT**  
2,30 €**Sous-tasse à thé**  
60455P Ø 13 cm x 12**P.U.HT**  
2,90 €

## Mug

En porcelaine blanche.



A



B

**66653P** E A - 30 cl x 12 **P.U.HT** 2,50 €  
**66654P** E B - 24 cl x 12 **P.U.HT** 2,30 €

## Pot à lait

En porcelaine blanche.

**1112P** 30 cl x 6 **P.U.HT** 6,70 €  
**58240P** 20 cl x 6 **P.U.HT** 6,30 €  
**58239P** 12 cl x 12 **P.U.HT** 5,90 €  
**51463P** 8 cl x 12 **P.U.HT** 5,60 €  
**41792P** 5 cl x 12 **P.U.HT** 5,30 €

## CAFETT

1<sup>er</sup> PRIX

## Cafett

En porcelaine blanche.

**Tasse à espresso**  
71221P 9 cl x 12 **P.U.HT** 2,20 €**Sous-tasse à espresso**  
65640P E Ø 13 cm x 12 **P.U.HT** 1,50 €**Tasse à espresso**  
65639P E 9 cl x 12 **P.U.HT** 2,00 €**Sous-tasse à espresso**  
65640P E Ø 13 cm x 12 **P.U.HT** 1,50 €**Tasse à thé**  
65645P E 18 cl x 12 **P.U.HT** 3,00 €**Sous-tasse à thé**  
65646P E Ø 15 cm x 12 **P.U.HT** 2,00 €**Tasse à café forme basse**  
65641P 9 cl x 12 **P.U.HT** 2,00 €**Sous-tasse à café**  
65642P Ø 13 cm x 12 **P.U.HT** 1,50 €**Tasse à thé**  
65643P 18 cl x 12 **P.U.HT** 3,20 €**Sous-tasse à thé**  
65644P E Ø 15 cm x 12 **P.U.HT** 2,00 €**Tasse à thé**  
65647P E 23 cl x 12 **P.U.HT** 3,10 €**Sous-tasse à thé**  
65644P E Ø 15 cm x 12 **P.U.HT** 2,00 €**Tasse à déjeuner**  
65648P E 28 cl x 12 **P.U.HT** 3,30 €**Sous-tasse à déjeuner**  
65649P E Ø 16 cm x 12 **P.U.HT** 2,30 €**Mug**  
65650P 30 cl x 12 **P.U.HT** 2,80 €**Bol empilable**  
65198P E Ø 13 cm - 40 cl x 12 **P.U.HT** 2,60 €  
65285P E Ø 15 cm - 60 cl x 12 **P.U.HT** 3,50 €**Bol**  
65200P E Ø 12,2 cm - 35 cl x 12 **P.U.HT** 5,40 €**Bol**  
65201P E Ø 13 cm - 40 cl x 12 **P.U.HT** 5,00 €  
65202P E Ø 14 cm - 60 cl x 12 **P.U.HT** 5,50 €**Crémier empilable**  
1002216P E 15 cl x 12 **P.U.HT** 3,30 €**Théière empilable**  
1002175P E 45 cl x 6 **P.U.HT** 7,10 €



# DOLCE

## Dolce

En verre sodocalcique.

<b>Tasse à expresso</b>		<b>P.U.HT</b>
<b>A 70193P</b> 7,4 cl	x 6	<b>1,30 €</b>
<b>Tasse à thé</b>		
<b>B 70194P</b> 30 cl	x 6	<b>1,80 €</b>
<b>Mug</b>		
<b>C 70196P</b> 27 cl	x 6	<b>1,70 €</b>
<b>Sous-tasse</b>		
<b>D 70197P</b> Ø 11.7 cm - Expresso	x 6	<b>1,60 €</b>
<b>D 70195P</b> Ø 15.2 cm - Thé/Mug	x 6	<b>1,80 €</b>

## Aroma

En verre trempé.

**ARCOROC** EXTRA RESISTANT

		<b>P.U.HT</b>
<b>57159P</b> 8 cl	x 12	<b>1,70 €</b>
<b>Tasse à thé</b>		
<b>57160P</b> 22 cl	x 12	<b>2,00 €</b>
<b>Sous-tasse à café</b>		
<b>1007070P</b> Ø 12 cm	x 6	<b>1,80 €</b>
<b>Sous-tasse à thé</b>		
<b>1007664P</b> Ø 14 cm	x 6	<b>2,10 €</b>

## Voluto

En verre trempé.

**ARCOROC** EXTRA RESISTANT

		<b>P.U.HT</b>
<b>A 1008035P</b> 9 cl	x 6	<b>0,83 €</b>
<b>Tasse à thé</b>		
<b>B 1008038P</b> 22 cl	x 6	<b>0,88 €</b>
<b>Tasse à déjeuner</b>		
<b>C 1008036P</b> 50 cl	x 6	<b>2,30 €</b>
<b>Mug</b>		
<b>D 1008037P</b> 25 cl	x 6	<b>0,88 €</b>
<b>Sous-tasse à expresso</b>		
<b>E 1007070P</b> Ø 12 cm	x 6	<b>1,80 €</b>
<b>Sous-tasse à thé / mug</b>		
<b>F 1007664P</b> Ø 14 cm	x 6	<b>2,10 €</b>

## Oslo

En verre trempé. Monture inox (dessous et anse).

		<b>P.U.HT</b>
<b>54230P</b> 22 cl	x 15	<b>3,40 €</b>

nouveau !

## Thermic Glass

En verre borosilicate double paroi.

*Luigi Dormioli* ITALY

		<b>P.U.HT</b>
<b>A 1013238P</b> 8,5 cl	x 2	<b>4,70 €</b>
<b>B 1013239P</b> 12 cl	x 2	<b>4,50 €</b>
<b>Mug</b>		
<b>C 1013236P</b> 32 cl	x 2	<b>6,20 €</b>
<b>Verre</b>		
<b>D 1013237P</b> 34 cl	x 2	<b>6,50 €</b>

## Tasse

En verre trempé.

**ARCOROC** VERRE TREMPÉ

		<b>P.U.HT</b>
<b>Kaleido</b>		
<b>1011396P</b> E Tasse à expresso 10 cl	x 6	<b>0,91 €</b>
<b>1011397P</b> Tasse à cappuccino 22 cl	x 6	<b>1,30 €</b>
<b>1011398</b> Tasse à thé 30 cl	x 24	<b>1,40 €</b>
<b>Cube</b>		
<b>1011403P</b> E Tasse à expresso 10 cl	x 6	<b>0,91 €</b>
<b>1011404P</b> Tasse à cappuccino 22 cl	x 6	<b>1,30 €</b>

## Rond décentré

		<b>P.U.HT</b>
<b>A 1011399P</b> E Sous-tasse Ø 14 cm à expresso	x 6	<b>0,98 €</b>
<b>B 1011402P</b> Sous-tasse Ø 14 cm à cappuccino	x 6	<b>0,98 €</b>

## Twice

En verre borosilicate double paroi.

**ARCOROC**

		<b>P.U.HT</b>
<b>69581P</b> 5,5 cl	x 6	<b>4,70 €</b>

nouveau !

## Picardie

En verre trempé.

**DURALEX** VERRE TREMPÉ

		<b>P.U.HT</b>
<b>1013216P</b> 9 cl	x 6	<b>0,57 €</b>

## Zinc

En verre pressé sodocalcique.

**La Rochère**

		<b>P.U.HT</b>
<b>1007405P</b> 10 cl	x 6	<b>2,20 €</b>

## Caffeino

En verre sodocalcique.

		<b>P.U.HT</b>
<b>65308P</b> 8,5 cl	x 6	<b>0,76 €</b>

## Diamond

En verre sodocalcique.

		<b>P.U.HT</b>
<b>1007475P</b> 8 cl	x 6	<b>0,54 €</b>

## Irish coffee

En verre sodocalcique.

		<b>P.U.HT</b>
<b>1011176P</b> 23 cl	x 6	<b>3,60 €</b>

## Java

En verre sodocalcique.

		<b>P.U.HT</b>
<b>70190P</b> 23 cl	x 12	<b>2,20 €</b>



## LES CRISTALLINS



Macassar  
> Page 136

Reveal Up  
> Page 136

Open Up  
> Page 137

Arom'up  
> Page 137

CEnologue Expert  
> Page 138

Open Up Arabesque  
> Page 138

Macaron Fascination  
> Page 139

Macaron  
> Page 139

Grands Cépages  
> Page 141

Sublym  
> Page 141



Cabernet  
> Page 142/143

Sensation Exalt  
> Page 143

Michelangelo  
> Page 144

D.O.C.  
> Page 144

T Glass  
> Page 145

Rubino  
> Page 145

Tre Sensi  
> Page 146

Uno  
> Page 146

Aurum  
> Page 146

## LES TREMPÉS RÉSISTANTS



New kalix  
> Page 147

Domaine  
> Page 147

Linéal  
> Page 147

Elisa  
> Page 148

Princessa  
> Page 148

Normandie  
> Page 148

Onyx  
> Page 149

## LES EMPILABLES



Amelia  
> Page 149

Colosseo  
> Page 149

Resto  
> Page 149

## LES SODOCALCIQUES



Allégro  
> Page 150

Viticole  
> Page 150

Élégance  
> Page 150

Napoli  
> Page 151

Savoie  
> Page 151

Vina  
> Page 151

Ballon  
> Page 152

Artois  
> Page 152

## LES SPÉCIFIQUES



Vin au verre  
> Page 153

Cocktails  
> Page 170

Flûtes  
> Page 171

Verres à digestif  
> Page 172

Verres à bières  
> Page 173

Les incassables  
> Page 174





## GOBELETS DE TABLE

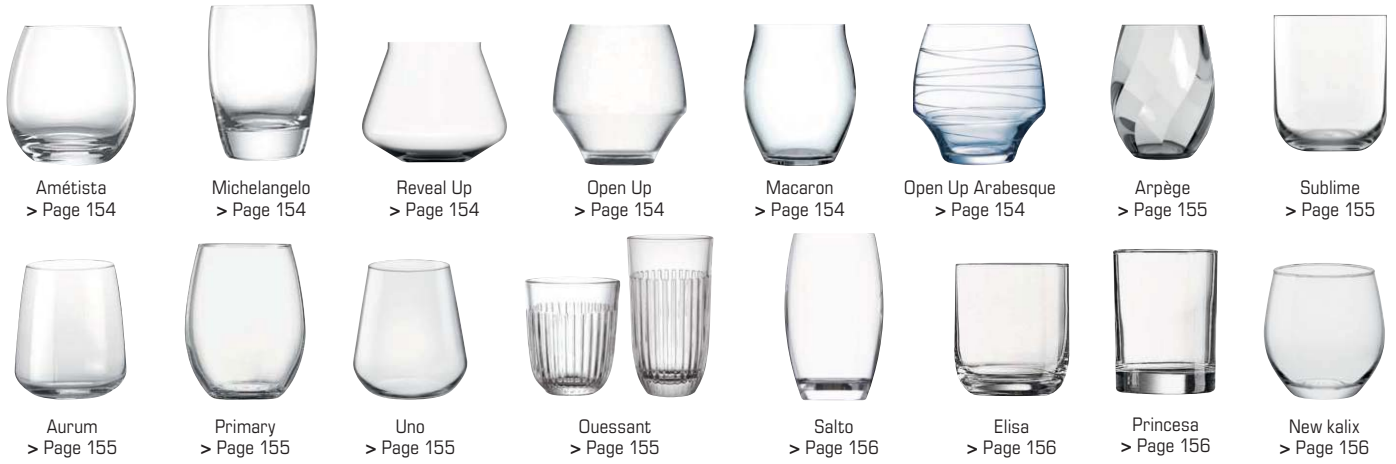

## GOBELETS DE COULEUR



## LES TREMPÉS



## CHICS ET ÉLÉGANTS DU BAR



## LES RELIEFS DU BAR



## LES DÉTOURNÉS DU BAR



## LES EMPILABLES DU BAR



## LES FONDAMENTAUX



# REVEAL'UP



nouveau !

## Macassar

En Cristallin.



Verre à pied  
Ø 9,3 x H. 20,8 cm - 35 cl  
1013292 x 12 P.U.HT 4,80 €



Verre à pied  
Ø 8,3 x H. 19,7 cm - 25 cl  
1013256 x 12 P.U.HT 4,40 €



Flûte  
Ø 6,1 x H. 23,3 cm - 17 cl  
1013293 x 12 P.U.HT 4,40 €

## Reveal'Up

En Krysta.



Verre à pied Intense  
1006220P Ø 11 x H. 23,4 cm - 55 cl x 6 P.U.HT 5,10 €  
✓ 1006221P Ø 10,4 x H. 22 cm - 45 cl x 6 P.U.HT 5,10 €



Verre à pied Soft  
1006224P Ø 9,7 x H. 24,5 cm - 50 cl x 6 P.U.HT 5,10 €  
✓ 1006222P Ø 9,1 x H. 23 cm - 40 cl x 6 P.U.HT 5,00 €  
1006223P Ø 8,3 x H. 21,5 cm - 30 cl x 6 P.U.HT 4,90 €



A

Jaugés à ~ 12,5 cl



B

Verre à pied jaugé  
A 1006603P Intense - Ø 10,7 x H. 21,5 cm - 45 cl x 6 P.U.HT 5,10 €  
B 1006602P Soft - Ø 9,2 x H. 22,5 cm - 40 cl x 6 P.U.HT 5,00 €



Flûte  
✓ 1006219P Ø 6,5 x H. 23 cm - 21 cl x 6 P.U.HT 4,90 €



Gobelet Intense  
1006604P Ø 10,1 x H. 8,6 cm - 40 cl x 6 P.U.HT 2,90 €



Gobelet Soft  
✓ 1006606P Ø 8,4 x H. 9,1 cm - 30 cl x 6 P.U.HT 2,90 €



Gobelet Soft avec socle fraîcheur  
1006605P Ø 9,7 x H. 11,07 cm - 30 cl x 6 P.U.HT 7,80 €



# OPEN UP

AROM'UP



## Open Up

En Krysta.



Verre à pied Tannic  
Ø 10,7 x H. 23,3 cm - 55 cl

59495P x6 P.U.HT 5,30 €



Verre à pied Universal tasting  
Ø 9,1 x H. 23,1 cm - 40 cl

59493P x6 P.U.HT 4,70 €



Verre à pied Soft  
Ø 10,3 x H. 22,8 cm - 47 cl

59492P x6 P.U.HT 4,70 €

**Open Up** : La collection dédiée aux vins jeunes. Tout dans la forme des verres Open Up a été pensé pour optimiser les qualités des vins jeunes en alliant un design de précision :

- Un buvant refermé, pour concentrer les arômes
- Un buvant de la paraison et sans bourrelet, pour un contact agréable sur les lèvres, et pour mieux diriger le vin en bouche
- Une cassure de la paraison, qui permet aux molécules de mieux se libérer et forme une jauge naturelle, qui aide le serveur à verser la quantité de vin optimale à sa bonne dégustation
- Une grande surface pour une oxygénation immédiate et un développement optimum des arômes. Pour les vins blancs jusqu'à 3 ans et les vins rouges jusqu'à 5 ans.



Verre à pied Round  
Ø 9,6 x H. 21,1 cm - 37 cl

59491P x6 P.U.HT 4,70 €



Verre à pied Pro tasting  
Ø 8,7 x H. 18 cm - 32 cl

61563P x6 P.U.HT 4,10 €



Flûte Effervescent  
Ø 7,4 x H. 23,4 cm - 20 cl

59490P x6 P.U.HT 4,70 €



Gobelet forme haute  
Ø 7,7 x H. 11,8 cm - 35 cl

68471P x6 P.U.HT 2,60 €



Gobelet forme basse  
Ø 9,3 x H. 9,4 cm - 38 cl

63135P x6 P.U.HT 2,60 €

## Arom'Up

En Krysta.



Verre à pied Fruity  
Ø 10,1 x H. 24,1 cm - 60 cl

1007069 x12 P.U.HT 2,90 €



Verre à pied Fruity  
Ø 9,1 x H. 21,5 cm - 43 cl

64270P x4 P.U.HT 2,70 €



Verre à pied Fruity  
Ø 8,3 x H. 19,5 cm - 35 cl

64271P x6 P.U.HT 2,70 €



Verre à pied Fruity  
Ø 7,6 x H. 17,8 cm - 25 cl

1005715P x6 P.U.HT 2,40 €



Flûte Floral  
Ø 7,4 x H. 21,1 cm - 21 cl

65359P x12 P.U.HT 2,70 €

KRYSTA



ART DE LA TABLE

# ŒNOLOGUE EXPERT



# OPEN UP ARABESQUE



## Œnologue Expert

En Krysta.



Verre à pied  
Ø 8,7 x H. 21,5 cm - 45 cl

**62388P** x6 P.U.HT  
**3,90 €**



Verre à pied  
Ø 8 x H. 20 cm - 35 cl

**62389P** x6 P.U.HT  
**3,90 €**



Flûte  
Ø 7,1 x H. 21,5 cm - 26 cl

**62404P** x6 P.U.HT  
**3,90 €**

## Open Up Arabesque

En Krysta.



Verre à pied Tannic  
Ø 10,7 x H. 23,3 cm - 55 cl

**70445P** x4 P.U.HT  
**6,10 €**



Verre à pied Universal tasting  
Ø 9,1 x H. 23,1 cm - 40 cl

**70209P** x4 P.U.HT  
**5,80 €**



Verre à pied Round  
Ø 9,6 x H. 21,1 cm - 37 cl

**1002655P** x4 P.U.HT  
**5,80 €**



Flûte Effervescent  
Ø 7,4 x H. 23,4 cm - 20 cl

**70210P** x4 P.U.HT  
**5,80 €**



Gobelet forme basse  
Ø 9,3 x H. 9,4 cm - 38 cl

**70331P** x4 P.U.HT  
**3,70 €**



Gobelet forme haute  
Ø 7,7 x H. 11,8 cm - 35 cl

**70446P** x4 P.U.HT  
**3,70 €**





KRYSTA

## Macaron Fascination

En Krysta.



nouveau !



Verre à pied  
Ø 10,8 x H. 22,8 cm - 60 cl

**1013250P** x6 P.U.HT 4,20 €



Verre à pied  
Ø 10,3 x H. 21,5 cm - 50 cl

**1013251P** x6 P.U.HT 4,20 €



Verre à pied  
Ø 9,5 x H. 20 cm - 40 cl

**1013252P** x6 P.U.HT 4,10 €

Buvant fin en forme de lyre pour une dégustation plus agréable  
Cheminée pour réduire la perception d'alcool au niveau du nez



## Macaron

En Krysta.



Verre à pied  
Ø 10 x H. 21,5 cm - 50 cl

**1011426P** x6 P.U.HT 5,00 €



Verre à pied  
Ø 9,3 x H. 20 cm - 40 cl

**1011427P** x6 P.U.HT 5,00 €



Flûte  
Ø 8,1 x H. 19,5 cm - 30 cl

**1011428P** x6 P.U.HT 4,90 €

Ses bords épousent naturellement les lèvres grâce à un design très spécifique qui procure un plaisir accru.

Une jauge naturelle ~12,5 cl se dessine à la cassure de la paraison du verre 40 cl et de la flûte.



Gobelet  
Ø 8,5 x H. 10,4 cm - 40 cl

**1011651** x24 P.U.HT 2,90 €

ART DE LA TABLE

— CRÉATEUR D'EXPÉRIENCES —



Krysta  
EXTRA STRONG  
CRYSTAL  
GLASS

- Superior Strength
- Complete Harmony
- Perfect Acoustics
- Impassioned Brilliance

[chefsommelier.com](http://chefsommelier.com)

Ligne élancée, jambe longue et mince, verre brillant de mille feux : la collection Sublym de Chef&Sommelier déploie sa silhouette harmonieuse et délicate au service de toutes les variétés de vins.

À assortir aux gobelets de la collection Primary.

Collection fabriquée en Krysta® concentré de technologie, lui confère pureté, éclat et résistance.

GRANDS CÉPAGES

SUBLYM

KRYSTA

## Grands Cépages

En Krysta.



Verre à pied  
Ø 10,1 x H. 23,8 cm - 62 cl

**64210P** x6 **P.U.HT**  
**3,50 €**



Verre à pied  
Ø 9,5 x H. 22,7 cm - 47 cl

**64209P** x6 **P.U.HT**  
**3,30 €**



Verre à pied  
Ø 8,5 x H. 21 cm - 35 cl

**65355P** x6 **P.U.HT**  
**3,10 €**



Verre à pied  
Ø 7,7 x H. 18,5 cm - 25 cl

**1005716P** x6 **P.U.HT**  
**2,90 €**



Flûte  
Ø 7 x H. 23,5 cm - 24 cl

**64207P** x6 **P.U.HT**  
**3,30 €**

## Sublym

En Krysta.



Verre à pied  
**1007730** Ø 5,8 x H. 26 cm - 55 cl  
**1007731P** Ø 5,8 x H. 25 cm - 45 cl  
**1007732P** Ø 8 x H. 23 cm - 35 cl



x 12 **P.U.HT**  
**2,90 €**  
x 6 **2,80 €**  
x 6 **2,70 €**



Verre à pied  
**1007733** Ø 7,2 x H. 20,7 cm - 25 cl  
**1013255P** Ø 8 x H. 17,7 cm - 35 cl

x 24 **P.U.HT**  
**2,60 €**  
x 6 **2,40 €**



Flûte  
**1007734P** Ø 6,5 x H. 24 cm - 21 cl



x 6 **P.U.HT**  
**2,80 €**

ART DE LA TABLE



# CABERNET

## Cabernet

En Krysta.

### Verre à pied Vins jeunes

Forme spécifiquement conçue pour mettre en valeur les arômes des vins jeunes.



Ø 10,4 x H. 22,3 cm - 58 cl

🛒 **62726P** x 12 **P.U.HT 3,40 €**



Ø 9,7 x H. 21,5 cm - 47 cl

🛒 **62715P** x 6 **P.U.HT 3,10 €**



Ø 9 x H. 20 cm - 35 cl

🛒 **62714P** x 6 **P.U.HT 2,60 €**

### Verre à pied forme Ballon

Facilite la circulation des arômes et des saveurs.



Ø 11,5 x H. 22,1 cm - 70 cl

🛒 **50149P** x 6 **P.U.HT 3,10 €**



Ø 10,6 x H. 20,9 cm - 58 cl

🛒 **50150P** x 6 **P.U.HT 2,90 €**



Ø 10 x H. 19,6 cm - 47 cl

🛒 **50151P** x 6 **P.U.HT 2,70 €**



Ø 9,1 x H. 18,2 cm - 35 cl

🛒 **50152P** x 6 **P.U.HT 2,50 €**





**Verre à pied forme Tulipe**

S'oriente vers une large gamme de vins : Bordeaux, Languedoc-Roussillon ou rouges italiens, mais aussi les blancs de Loire, d'Alsace et Espagne.



Ø 9,5 x H. 23 cm - 58 cl

**1000534P** x 6 **P.U.HT 2,70 €**



Ø 9 x H. 22 cm - 47 cl

**50146P** x 6 **P.U.HT 2,60 €**



Ø 8,1 x H. 20,2 cm - 35 cl

**50147P** x 6 **P.U.HT 2,30 €**



Ø 7,2 x H. 18 cm - 25 cl

**50148P** x 6 **P.U.HT 2,20 €**



Ø 6,6 x H. 16,5 cm - 19 cl

**1000535P** x 6 **P.U.HT 2,10 €**



**Flûte**  
Ø 7 x H. 22,5 cm - 16 cl

**1000533P** x 6 **P.U.HT 2,20 €**

**SENSATION EXALT**



**CeS**  
**Chef de Sommelier**  
FRANCE

KRYSTA

**Krysta, le Cristallin haute performance**  
**FIN ET RÉSISTANT** : Avec une épaisseur de seulement 1mm au buvant, Krysta est 30% plus résistant\*. Malgré sa finesse, le pied des verres en Krysta est deux fois plus résistant à la torsion\*  
**COMPLÈTE TRANSPARENCE** : Krysta est le plus pur et le plus transparent des Cristallins du marché. La parfaite maîtrise de sa composition, la qualité de la silice utilisée et la fusion à très haute température confère au Krysta une transparence parfaite.  
**BRILLANCE LONGUE DURÉE** : Krysta garantit une brillance très longue durée. Après 2000 cycles en lave-vaisselle professionnel, Krysta reste toujours aussi brillant et transparent.  
**UNE PARFAITE ACCOUSTIQUE** : La composition exclusive de Krysta lui confère un son pur et clair, comparable à celui du meilleur cristal.  
 \*Par rapport aux autres verres en Cristallin sur le marché.



**Sensation Exalt**

En Krysta.



Jambe étirée

**Verre à pied**  
Ø 8,6 x H. 20,5 cm - 41 cl

**60408P** x 12 **P.U.HT 2,90 €**



**Verre à pied**  
Ø 8 x H. 19,5 cm - 31 cl

**60409P** x 12 **P.U.HT 2,60 €**



**Verre à pied**  
Ø 7,4 x H. 18,5 cm - 25 cl

**60410P** x 12 **P.U.HT 2,40 €**



**Verre à pied**  
Ø 7 x H. 18 cm - 20 cl

**60411P** x 12 **P.U.HT 2,40 €**



**Flûte**  
Ø 7 x H. 21 cm - 19 cl

**60412P** x 12 **P.U.HT 2,40 €**



ART DE LA TABLE



D.O.C.



## Michelangelo

En Sparkx.



Verre à pied  
**31645P** Ø 8,2 x H. 18,8 cm - 34 cl  
**1476P** Ø 7,3 x H. 17,5 cm - 22,5 cl  
**1477P** Ø 6,7 x H. 16,6 cm - 19 cl

☐ **P.U.HT**  
 x 6 **3,80 €**  
 x 6 **3,00 €**  
 x 6 **2,90 €**

Flûte  
**1478P** Ø 6,4 x H. 18,5 cm - 16 cl  
**1479P** Ø 6 x H. 18,2 cm - 11,5 cl

☐ **P.U.HT**  
 x 6 **2,90 €**  
 x 6 **2,50 €**

Chope forme haute  
**65390P** Ø 6,3 x H. 14,6 cm - 31 cl  
 Gobelet forme basse  
**65391P** Ø 8 x H. 10,9 cm - 34,5 cl

☐ **P.U.HT**  
 x 12 **3,00 €**  
 ☐ **P.U.HT**  
 x 6 **3,20 €**



## D.O.C.

En Sparkx.



Verre à pied  
 Ø 7,9 x H. 18,2 cm - 41 cl

☐ **P.U.HT**  
**35668P** x 6 **4,80 €**

Verre à pied  
 Ø 7,3 x H. 17,4 cm - 31 cl

☐ **P.U.HT**  
**35669P** x 6 **3,40 €**

Verre à pied  
 Ø 6,5 x H. 15,5 cm - 21,5 cl

☐ **P.U.HT**  
**35670P** x 6 **2,80 €**

Verre à pied  
 Ø 6 x H. 13,6 cm - 12 cl

☐ **P.U.HT**  
**35671P** x 6 **2,80 €**



# WINE GLASS



# RUBINO

## T Glass

En SON.hyx.



nouveau !



Verre à pied  
Ø 10,6 x H. 14 cm - 61 cl  
**1013245** x 16 **P.U.HT 3,10 €**



Verre à pied  
Ø 8,4 x H. 14 cm - 44 cl  
**1011381** x 16 **P.U.HT 2,90 €**



Verre à pied  
Ø 7,9 x H. 13,1 cm - 35 cl  
**1011382** x 4 **P.U.HT 2,90 €**



Verre à pied  
Ø 6,9 x H. 15,7 cm - 27 cl  
**1011383** x 16 **P.U.HT 2,90 €**

## Rubino

En Sparkx.



Verre à pied  
Ø 8,1 x H. 18,1 cm - 37 cl  
**48560P** x 6 **P.U.HT 2,90 €**



Verre à pied  
Ø 7,3 x H. 17,1 cm - 27,6 cl  
**48562P** x 6 **P.U.HT 2,70 €**



Verre à pied  
Ø 6,7 x H. 15,5 cm - 21 cl  
**48559P** x 6 **P.U.HT 2,60 €**

### Le sparkx

Le sparkx est un matériau développé par Bormioli Luigi qui offre : Extrême transparence et pureté. Résistance au lavage : garantie à 2.000 cycles de lavage industriel sans altération. Solidité : résistance aux chocs mécaniques augmentée de 30 %. Eco-respectueux : ne contient ni plomb ni aucun métaux lourds. Ces produits bénéficient également d'un renforcement au niveau de la jambe grâce à un traitement spécifique au titane. Ce procédé procure une résistance accrue à l'abrasion, principale responsable de la fragilité des jambes à l'utilisation professionnelle.



SPARKX



ART DE LA TABLE



UNO



AURUM



### Tre Sensi

En Star glass.



Verre à pied  
Ø 9,2 x H. 23,5 cm - 55 cl

**1006198P** x 6 **P.U.HT**  
**3,30 €**



Verre à pied  
Ø 8,5 x H. 22 cm - 43 cl

**1006199P** x 6 **P.U.HT**  
**3,00 €**



Verre à pied  
Ø 7,6 x H. 20,4 cm - 30,5 cl

**1006200P** x 6 **P.U.HT**  
**2,90 €**

### Uno

En Star glass.



Verre à pied  
**1005322** Ø 10,4 x H. 24,3 cm - 64 cl  
**1005323** Ø 10 x H. 23,3 cm - 56 cl

x 12 **P.U.HT**  
**5,00 €**  
x 12 **4,50 €**



Verre à pied  
**1005324P** Ø 9,5 x H. 22 cm - 47 cl  
**1005325P** Ø 8,9 x H. 20,7 cm - 38 cl

x 6 **P.U.HT**  
**3,80 €**  
x 6 **3,50 €**



Flûte  
Ø 6,7 x H. 24,3 cm - 28 cl

**1005326** x 12 **P.U.HT**  
**3,80 €**



Gobelet  
Ø 9,2 x H. 10,3 cm - 45 cl

**1005327P** x 6 **P.U.HT**  
**2,00 €**

### Aurum

En Star glass.



Verre à pied Burgunder  
Ø 8,9 x H. 21,3 cm - 43 cl

**59513P** x 6 **P.U.HT**  
**3,80 €**



Verre à pied  
Ø 8,3 x H. 20,3 cm - 35 cl

**59516P** x 6 **P.U.HT**  
**3,70 €**



Flûte  
Ø 6,8 x H. 23,5 cm - 23 cl

**59514P** x 6 **P.U.HT**  
**3,10 €**



Gobelet  
Ø 8,2 x H. 9,5 cm - 36 cl

**59509P** x 6 **P.U.HT**  
**1,90 €**





**KALIX**



**DOMAINE**



**LINEAL**

**Kalix**

En verre trempé.



Verre à pied  
**71204P** E Ø 7,7 x H. 18 cm - 27 cl x 12 **2,80 €**  
**71206P** E Ø 7,7 x H. 16,9 cm - 22 cl x 12 **2,60 €**

Flûte  
**71205P** E Ø 5,8 x H. 19,6 cm - 17 cl x 12 **2,10 €**

Gobelet forme haute  
**71202P** Ø 7,5 x H. 13 cm - 40 cl x 12 **1,70 €**  
 Gobelet forme basse  
**71203P** Ø 8,2 x H. 8,5 cm - 30 cl x 12 **1,60 €**

nouveau !

**Domaine**

En verre trempé.

**ARCOROC** EXTRA RESISTANT



Verre à pied  
**1011435** Ø 9,06 x H. 21,94 cm - 47 cl x 24 **1,80 €**  
**1011436** Ø 8,3 x H. 20,2 cm - 37 cl x 24 **1,70 €**

Verre à pied  
**1011437P** Ø 7,6 x H. 18,2 cm - 27 cl x 6 **1,60 €**

Flûte  
**1011438** Ø 5,56 x H. 22,4 cm - 16 cl x 24 **1,50 €**

**Linéal**

En verre trempé.

**ARCOROC** EXTRA RESISTANT

Gobelet Linéal,  
 nous consulter



Verre à pied  
**1008185** Ø 9,3 x H. 21,5 cm - 45 cl x 24 **2,90 €**  
**57201P** Ø 8,2 x H. 19,7 cm - 31 cl x 12 **2,60 €**

Verre à pied  
**57203P** E Ø 7,7 x H. 17,4 cm - 25 cl x 12 **2,30 €**  
**57202P** E Ø 7 x H. 16,5 cm - 19 cl x 12 **2,10 €**

Flûte  
**57204P** E Ø 7 x H. 19,6 cm - 18 cl x 12 **2,20 €**

VERRE TREMPÉ



ART DE LA TABLE

# ELISA



# PRINCESA



# NORMANDIE



## Elisa

En verre trempé.



Verre à pied					
45482P	Ø 7,6 x H. 19,4 cm - 30 cl	x 12	<b>P.U.HT</b>	<b>2,70 €</b>	
45483P	Ø 7,2 x H. 17,6 cm - 23 cl	x 12	<b>2,20 €</b>		
45484P	Ø 6,5 x H. 16,6 cm - 18 cl	x 6	<b>2,10 €</b>		

Flûte					
45485P	Ø 5,3 x H. 19,2 cm - 17 cl	x 6	<b>P.U.HT</b>	<b>2,10 €</b>	

ARCOROC EXTRA RESISTANT



Gobelet forme haute					
1000531P	Ø 5,6 x H. 10,8 cm - 19 cl	x 6	<b>P.U.HT</b>	<b>1,10 €</b>	
Gobelet forme basse					
62406P	Ø 7,1 x H. 8,2 cm - 23 cl	x 12	<b>P.U.HT</b>	<b>1,10 €</b>	

## Princesa

En verre trempé.



Verre à pied					
43451P	Ø 7,4 x H. 19,7 cm - 31 cl	x 6	<b>P.U.HT</b>	<b>2,60 €</b>	
43452P	Ø 6,7 x H. 17,4 cm - 23 cl	x 12	<b>2,10 €</b>		

Verre à pied					
43453P	Ø 6,9 x H. 16,5 cm - 19 cl	x 12	<b>P.U.HT</b>	<b>2,00 €</b>	
43454P	Ø 5,8 x H. 15,5 cm - 14 cl	x 12	<b>2,00 €</b>		

Flûte  
Ø 5 x H. 19,6 cm - 15 cl

43455P	x 12	<b>P.U.HT</b>	<b>2,00 €</b>		
--------	------	---------------	---------------	--	--

ARCOROC EXTRA RESISTANT

Pour usage intensif



Gobelet  
Ø 6,4 x H. 8,5 cm - 17 cl

62405P	x 48	<b>P.U.HT</b>	<b>1,10 €</b>		
--------	------	---------------	---------------	--	--

## Normandie

En verre trempé.



Verre à pied					
53540P	Ø 7,4 x H. 16,2 cm - 24 cl	x 48	<b>P.U.HT</b>	<b>1,70 €</b>	

Verre à pied					
53539P	Ø 6,7 x H. 14,5 cm - 16 cl	x 48	<b>P.U.HT</b>	<b>1,70 €</b>	
31664P	Ø 5,9 x H. 12,7 cm - 11 cl	x 12	<b>1,70 €</b>		

Flûte					
1548P	Ø 5,3 x H. 17,3 cm - 14 cl	x 12	<b>P.U.HT</b>	<b>1,90 €</b>	

ARCOROC EXTRA RESISTANT



ONYX

RESTO

## Onyx

En verre trempé.



Pour usage intensif



Verre à pied  
**49701P** Ø 7,3 x H. 15,9 cm - 26 cl x 12 **P.U.HT 2,00 €**

Verre à pied  
**49703P** Ø 6,8 x H. 15,1 cm - 20 cl x 12 **P.U.HT 1,80 €**

## LES EMPILABLES

## Amélia

En verre trempé.



Verre à pied  
Ø 8,5 x H. 12,5 cm - 32 cl  
**40056P** x 12 **P.U.HT 2,40 €**

Verre à pied  
Ø 7,9 x H. 11,7 cm - 25 cl  
**33799P** E x 12 **P.U.HT 1,70 €**

Verre à pied  
Ø 7,2 x H. 10,6 cm - 19 cl  
**33798P** E x 12 **P.U.HT 1,60 €**

Verre à pied  
Ø 6,1 x H. 10,1 cm - 16 cl  
**33797P** E x 12 **P.U.HT 1,60 €**

## Colosséo

En verre trempé.



## Resto

En verre trempé.



Verre à pied  
Ø 8,2 x H. 13,7 cm - 28 cl  
**59518P** x 12 **P.U.HT 2,20 €**

Verre à pied  
Ø 7,4 x H. 12,4 cm - 22 cl  
**59519P** x 12 **P.U.HT 2,10 €**

Verre à pied  
Ø 7,6 x H. 12,7 cm - 25 cl  
**1011425P** E x 6 **P.U.HT 0,87 €**

Verre à pied  
Ø 6,4 x H. 10,6 cm - 15 cl  
**1011424P** E x 6 **P.U.HT 0,80 €**

VERRE TREMPÉ



ART DE LA TABLE



VITICOLE



ÉLÉGANCE

## Allegro

En verre sodocalcique.



Verre à pied  
Ø 8,4 x H. 23,4 cm - 45 cl

**1007017P** x 6 **P.U.HT**  
**3,00 €**



Verre à pied  
Ø 7,9 x H. 21,9 cm - 35 cl

**69662P** x 12 **P.U.HT**  
**2,50 €**



Verre à pied  
Ø 7,3 x H. 20,2 cm - 27 cl

**69663P** x 12 **P.U.HT**  
**2,20 €**



Dotée d'un point  
mousse pour une  
effervescence  
parfaite.

Flûte  
Ø 5,5 x H. 22,4 cm - 16 cl

**69664P** x 12 **P.U.HT**  
**2,20 €**

## Viticole

En verre sodocalcique.

ARCOROC



Verre à pied  
**57108P** Ø 7,3 x H. 17,5 cm - 31 cl



**P.U.HT**  
**2,20 €**

Verre à pied  
**43467P** Ø 6,5 x H. 15,5 cm - 21,5 cl



**P.U.HT**  
**1,80 €**



Spécial vin  
au verre  
en page : 153



Verre à pied jaugé à ~ 12,5 et 14,5 cl  
**60088P** Ø 6,5 x H. 15,5 cm - 21,5 cl



**P.U.HT**  
**1,30 €**

## Elégance

En verre sodocalcique.

ARCOROC



Verre à pied  
**1502P** Ø 8,1 x H. 18 cm - 31 cl x 12 **P.U.HT**  
**2,10 €**  
**1503P** Ø 7,4 x H. 16,6 cm - 24,5 cl x 12 **P.U.HT**  
**1,60 €**  
**53538P** Ø 7,4 x H. 16,6 cm - 24,5 cl x 48 **P.U.HT**  
**1,40 €**

Verre à pied  
**1504P** Ø 6,9 x H. 15,3 cm - 19 cl x 12 **P.U.HT**  
**1,50 €**  
**53537P** Ø 6,9 x H. 15,3 cm - 19 cl x 48 **P.U.HT**  
**1,30 €**  
**1505P** Ø 6,4 x H. 14,2 cm - 14,5 cl x 12 **P.U.HT**  
**1,30 €**  
**50655P** Ø 5,9 x H. 13,4 cm - 12 cl x 12 **P.U.HT**  
**1,30 €**

Flûte  
**31659P** Ø 5,8 x H. 17,5 cm - 17 cl x 12 **P.U.HT**  
**1,40 €**  
**1506P** Ø 5,8 x H. 17,9 cm - 13 cl x 12 **P.U.HT**  
**1,30 €**  
**2154P** Ø 5,8 x H. 15,9 cm - 10 cl x 12 **P.U.HT**  
**1,30 €**





# NAPOLI

## Napoli

En verre sodocalcique.



# SAVOIE



# VINA



Verre à pied  
Ø 7,1 x H. 14,1 cm - 24 cl

1487P x 12 P.U.HT 1,30 €



Verre à pied  
Ø 6,55 x H. 12,5 cm - 18 cl

1488P x 12 P.U.HT 1,20 €



Verre à pied  
Ø 6 x H. 11,4 cm - 12 cl

1489P x 12 P.U.HT 1,20 €



Flûte  
Ø 5,7 x H. 15,6 cm - 15 cl

1490P x 12 P.U.HT 1,30 €

## Savoie

En verre sodocalcique.



Verre à pied  
Ø 7,5 x H. 15,2 cm - 24 cl

1499P x 12 P.U.HT 1,30 €



Verre à pied  
Ø 6,9 x H. 14 cm - 19 cl

1500P x 12 P.U.HT 1,20 €



Verre à pied  
Ø 6,4 x H. 13,4 cm - 15 cl

1501P x 12 P.U.HT 1,20 €



Flûte  
Ø 5 x H. 17 cm - 17 cl

40055P x 12 P.U.HT 1,20 €

## 1<sup>er</sup> PRIX

### Vina

En verre sodocalcique. Une paraison classique, une jambe haute pour une mise en table harmonieuse.



Verre à pied  
Ø 8,6 x H. 21,8 cm - 48 cl

1007465 x 24 P.U.HT 1,50 €



Verre à pied  
Ø 8 x H. 20,2 cm - 36 cl

1007464P x 6 P.U.HT 1,40 €

ARTOIS

BALLON



**Ballon**

En verre sodocalcique.

ARCOROC



Verre à pied

**65363P** E Ø 7,5 x H. 15,2 cm - 25 cl  
**1530P** E Ø 7,7 x H. 13 cm - 19 cl



**P.U.HT**  
**0,87 €**  
**0,84 €**

Verre à pied

**1531P** E Ø 7,1 x H. 11,8 cm - 15 cl  
**1532P** Ø 6,8 x H. 11,3 cm - 12 cl  
**1533P** Ø 6,2 x H. 10,2 cm - 9,5 cl



**P.U.HT**  
**0,84 €**  
**0,84 €**

Coupe

**1534P** E Ø 8,8 x H. 10,4 cm - 13 cl



**P.U.HT**  
**1,10 €**

**Artois**

En verre sodocalcique.

La Rochère



Verre à pied

**1005643** Ø 8,3 x H. 12,6 cm - 31,5 cl



**P.U.HT**  
**2,80 €**

Verre à pied

**1005642P** Ø 7,8 x H. 11 cm - 23,7 cl



**P.U.HT**  
**2,60 €**



# CABERNET

## SPÉCIAL VIN AU VERRE

### Cabernet

En Krysta.



Verre à pied jaugé à ~ 12,5 et 14,5 cl  
 1003336P Ø 8,1 x H. 20,2 cm - 35 cl x 6 P.U.HT 2,90 €

### DOC

En Sparkx.



Verre à pied jaugé à ~ 12,5 cl  
 55706P Ø 6,5 x H. 15,5 cm - 21,5 cl x 6 P.U.HT 3,20 €

### Viticole

En verre sodocalcique.



Verre à pied jaugé à ~ 12,5 et 14,5 cl  
 60088P Ø 6,5 x H. 15,5 cm - 21,5 cl x 12 P.U.HT 1,90 €

### Reveal Up Soft

En Krysta.



Verre à pied jaugé à ~ 12,5 cl  
 1006602P Ø 9,2 x H. 22,5 cm - 40 cl x 6 P.U.HT 5,00 €

### Ais

En Star Glass.



Verre à pied jaugé à ~ 15 cl  
 1005396P Ø 8,5 x H. 22 cm - 43,5 cl x 6 P.U.HT 3,50 €

SPÉCIAL VIN AU VERRE



ART DE LA TABLE



# AMÉTISTA



# REVEAL'UP

## Open Up Arabesque

En Krysta.



Gobelet forme basse  
Ø 9,3 x H. 9,4 cm - 38 cl

**70331P** x 4 **P.U.HT**  
**3,70 €**



Gobelet forme haute  
Ø 7,7 x H. 11,8 cm - 35 cl

**70446P** x 4 **P.U.HT**  
**3,70 €**

## Macaron

En Krysta.



Gobelet  
Ø 8,5 x H. 10,4 cm - 40 cl

**1011651** x 24 **P.U.HT**  
**2,90 €**

## Michelangelo

En Sparkx. Ce verre à la jambe étirée est un incontournable de la verrerie, alliant brillance et fonctionnalité.



Gobelet forme basse  
Ø 8 x H. 10,9 cm - 34,5 cl

**65391P** x 6 **P.U.HT**  
**3,20 €**



Gobelet forme haute  
Ø 6,3 x H. 14,6 cm - 31 cl

**65390P** x 12 **P.U.HT**  
**3,00 €**

## Reveal'Up

En Krysta.

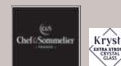

Gobelet Intense  
Ø 10,1 cm x H. 8,6 cm - 40 cl

**1006604P** x 6 **P.U.HT**  
**2,90 €**



Gobelet Soft  
Ø 8,4 cm x H. 9,1 cm - 30 cl

**1006606P** x 6 **P.U.HT**  
**2,90 €**

## Amétista

En Sparkx.



Gobelet forme basse  
Ø 8,7 x H. 9,1 cm - 34 cl

**56799P** x 6 **P.U.HT**  
**3,10 €**



Gobelet forme haute  
Ø 8,7 x H. 12 cm - 46 cl

**57000P** x 6 **P.U.HT**  
**3,10 €**

## Open Up

En Krysta.



Gobelet forme haute  
Ø 7,7 x H. 11,8 cm - 35 cl

**68471P** x 6 **P.U.HT**  
**2,60 €**



Gobelet forme basse  
Ø 9,3 x H. 9,4 cm - 38 cl

**63135P** x 6 **P.U.HT**  
**2,60 €**





SUBLIME



ARPÈGE

## Ouessant

En verre pressé sodocalcique.

La Rochère



Gobelet forme basse

**1007407P** Ø 8 x H. 9,5 cm - 29 cl

x 6 **P.U. HT**  
**2,60 €**

Gobelet forme haute

**1007408P** Ø 8,1 x H. 14,7 cm - 45 cl

x 6 **P.U. HT**  
**2,80 €**

## Sublime

En SON.hyx.



Gobelet forme basse

**1011386P** Ø 7,8 x H. 9,2 cm - 35 cl

x 4 **P.U. HT**  
**2,20 €**

Gobelet forme haute

**1011385P** Ø 7,2 x H. 13,3 cm - 45 cl

x 4 **P.U. HT**  
**2,20 €**

## Uno

En Star glass.



Gobelet

**1005327P** Ø 9,2 x H. 10,3 cm - 45 cl

x 6 **P.U. HT**  
**2,00 €**

## Aurum

En Star glass.



Gobelet

**59509P** Ø 8,2 x H. 9,5 cm - 36 cl

x 6 **P.U. HT**  
**1,90 €**

## Arpège

En Krysta.

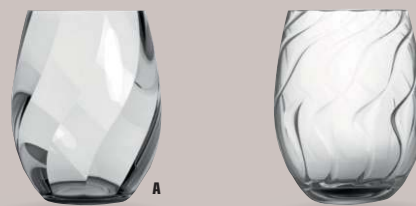

Gobelet forte

**A 1011480** Ø 8,1 cm x H. 10,2 cm - 35 cl

x 24 **P.U. HT**  
**1,90 €**

Gobelet leggero

**B 1011481** Ø 8,1 cm x H. 10,2 cm - 35 cl

x 24 **P.U. HT**  
**1,90 €**

## Primary

En Krysta.



Gobelet forme basse

**68463P** Ø 8,1 x H. 10,2 cm - 36 cl

x 6 **P.U. HT**  
**1,70 €**

Gobelet forme haute

**68464P** Ø 8,7 x H. 11 cm - 44 cl

x 6 **P.U. HT**  
**1,90 €**

Gobelets de table



ART DE LA TABLE



# NEW KALIX



# OFFICINA



# SALTO

## Salto

En verre sodocalcique.

ARCOROC

## Lima

En Krysta.



Gobelet forme basse

✓ **65372P** Ø 9,4 x H. 8 cm - 35 cl

6 P.U.HT  
x 6 **1,70 €**

Gobelet forme haute

✓ **65371P** Ø 8,8 x H. 11 cm - 38 cl

6 P.U.HT  
x 6 **1,70 €**



Gobelet forme haute

**1011430** Ø 7,7 x H. 13 cm - 40 cl

6 P.U.HT  
x 24 **1,70 €**

## New Kalix

En verre trempé.



Gobelet forme basse

**71203P** Ø 8,2 x H. 8,5 cm - 30 cl

12 P.U.HT  
x 12 **1,60 €**

Gobelet forme haute

**71202P** Ø 7,5 x H. 13 cm - 40 cl

12 P.U.HT  
x 12 **1,70 €**

## Officina 1825

En verre sodocalcique.



nouveau !



Gobelet forme basse

**1013330P** Ø 8,7 x H. 8,3 cm - 30 cl

6 P.U.HT  
x 6 **1,70 €**



Gobelet forme haute

**1007479P** Ø 7,9 x H. 12,3 cm - 30 cl

6 P.U.HT  
x 6 **1,70 €**

## Maléa

En verre sodocalcique.

ARCOROC



Gobelet forme basse

✓ **1000578P** Ø 7,7 x H. 10,5 cm - 30 cl

6 P.U.HT  
x 6 **1,40 €**

Gobelet forme haute

✓ **1000541P** Ø 7,6 x H. 12,6 cm - 35 cl

6 P.U.HT  
x 6 **1,40 €**



Gobelet forme basse

✓ **53595P** Ø 9 x H. 8,4 cm - 32 cl

6 P.U.HT  
x 6 **1,30 €**

Gobelet forme haute

✓ **53594P** Ø 7,6 x H. 12,1 cm - 35 cl

6 P.U.HT  
x 6 **1,30 €**

## Elisa

En verre trempé.

ARCOROC EXTRA RESISTANT



Gobelet forme basse

✓ **62406P** Ø 7,1 x H. 8,2 cm - 23 cl

12 P.U.HT  
x 12 **1,10 €**

Gobelet forme haute

**1000531P** Ø 5,6 x H. 10,8 cm - 19 cl

6 P.U.HT  
x 6 **1,10 €**

## Princesa

En verre trempé.

ARCOROC EXTRA RESISTANT



**62405P** Ø 6,4 x H. 8,5 cm - 17 cl

48 P.U.HT  
x 48 **1,10 €**



TWINS



BAYA

**Twins**

En verre. Gobelet double paroi, ciselé à la main.



Ø 8,5 x H. 9 cm - 27 cl  
1011645 Rouge

x 24 P.U.HT  
17,75 €

Boîte de 24 :  
avec 3 décors différents,  
soit 8 verres de chaque.



Ø 8,5 x H. 9 cm - 27 cl  
1011644 Noir

x 24 P.U.HT  
17,75 €



Ø 8,5 x H. 9 cm - 27 cl  
1011646 Bleu

x 24 P.U.HT  
17,75 €

**Baya**

En verre sodocalcique.



Ø 8,4 x H. 10 cm - 30 cl  
1005097P Gris  
1005098P Rouge

x 4 P.U.HT  
3,60 €  
x 4 4,60 €



Ø 8,4 x H. 10 cm - 30 cl  
1005095P Ambre  
1005096P Bleu nuit

x 4 P.U.HT  
3,60 €  
x 4 3,60 €



Ø 8,4 x H. 10 cm - 30 cl  
1005099P Vert olive  
1005100P Violine

x 4 P.U.HT  
3,60 €  
x 4 3,60 €

Gobelets de couleur



ART DE LA TABLE

## Vénécia

En cristallin soufflé bouche. La fabrication artisanale de ces produits peut induire des nuances de couleurs et d'épaisseur d'un verre à un autre, chaque verre étant une création unique.



Gobelet Ambre

**62319P** Ø 8 x H. 10,5 cm - 26 cl



**P.U.HT**  
**5,20 €**



Gobelet Orange

**62321P** Ø 8 x H. 10,5 cm - 26 cl



**P.U.HT**  
**5,20 €**



Gobelet Noir

**64589P** Ø 8 x H. 10,5 cm - 26 cl



**P.U.HT**  
**5,20 €**



Gobelet Bleu

**62324P** Ø 8 x H. 10,5 cm - 26 cl



**P.U.HT**  
**5,20 €**



Gobelet Turquoise

**62323P** Ø 8 x H. 10,5 cm - 26 cl



**P.U.HT**  
**5,20 €**



Gobelet Rouge

**62320P** Ø 8 x H. 10,5 cm - 26 cl



**P.U.HT**  
**5,20 €**



Gobelet Gris

**64588P** Ø 8 x H. 10,5 cm - 26 cl



**P.U.HT**  
**5,20 €**



Gobelet Vert olive

**64587P** Ø 8 x H. 10,5 cm - 26 cl



**P.U.HT**  
**5,20 €**



Gobelet Vert

**62322P** Ø 8 x H. 10,5 cm - 26 cl



**P.U.HT**  
**5,20 €**



Gobelet Lilas

**64590P** Ø 8 x H. 10,5 cm - 26 cl



**P.U.HT**  
**5,20 €**







# PRIMARIFIC



# SALTO COLOR STUDIO

GOBELETS DE COULEUR

## Primarific

En Krysta. Résiste à plus de 2000 lavages industriels.



Ø 10,2 x H. 8,1 cm - 36 cl

**1011412P** Blanc mat  
**1011413** Noir mat



**P.U.HT**  
x 6 **3,10 €**  
x 24 **3,10 €**



Ø 10,2 x H. 8,1 cm - 36 cl

**1011414** Rouge métallisée  
**1005713P** Cuivre



**P.U.HT**  
x 24 **3,10 €**  
x 6 **3,10 €**



Ø 10,2 x H. 8,1 cm - 36 cl

**1005712P** Argent  
**1005714P** Or



**P.U.HT**  
x 6 **3,10 €**  
x 6 **3,10 €**

## Salto Color Studio

En verre sodocalcique. Coloration par spray.  
Résiste à plus de 2 000 lavages en lave-vaisselle.



Gobelet forme haute

**1005724** Ø 7,6 x H. 12,1 cm - 35 cl

**P.U.HT**  
x 24 **2,40 €**



Gobelet forme basse

**1005721P** Ø 8,9 x H. 8,3 cm - 32 cl

**P.U.HT**  
x 24 **2,40 €**



Gobelet forme haute

**1005725** Ø 7,6 x H. 12,1 cm - 35 cl

**P.U.HT**  
x 24 **2,40 €**



Gobelet forme basse

**1005719P** Ø 8,9 x H. 8,3 cm - 32 cl

**P.U.HT**  
x 24 **2,40 €**

## Salto

En verre sodocalcique.



Gobelet forme haute

**55747P** Ø 7,6 x H. 12,1 cm - 35 cl

**P.U.HT**  
x 6 **1,40 €**



Gobelet forme basse

**55746P** Ø 9 x H. 8,4 cm - 32 cl

**P.U.HT**  
x 6 **1,40 €**



ART DE LA TABLE



# ARTIC

## Artic

En verre sodocalcique.



Gobelet Bleu nuit

**1009583P** E Ø 8,5 x H. 6,8 cm - 22 cl



x 4

**P.U. HT**  
**3,70 €**



Gobelet Parme

**1009586P** E Ø 8,5 x H. 6,8 cm - 22 cl



x 4

**P.U. HT**  
**3,70 €**



Gobelet Turquoise

**1009584P** E Ø 8,5 x H. 6,8 cm - 22 cl



x 4

**P.U. HT**  
**3,70 €**



Gobelet Vert

**1009585P** E Ø 8,5 x H. 6,8 cm - 22 cl



x 4

**P.U. HT**  
**3,70 €**



# DIAMOND

## Diamond

En verre sodocalcique.



Gobelet Vert

**71207P** Ø 8,4 x H. 9,2 cm - 30,5 cl



x 6

**P.U. HT**  
**1,80 €**



Gobelet Bleu

**71208P** Ø 8,4 x H. 9,2 cm - 30,5 cl



x 6

**P.U. HT**  
**1,80 €**



Gobelet Violet

**71209P** Ø 8,4 x H. 9,2 cm - 30,5 cl



x 6

**P.U. HT**  
**1,80 €**



# ROCK BAR

## Rock bar

En verre trempé.



Gobelet Bleu

**1000385P** E Ø 8,4 x H. 9,2 cm - 27 cl



x 6

**P.U. HT**  
**1,50 €**



Gobelet Orange

**1000389P** E Ø 8,4 x H. 9,2 cm - 27 cl



x 6

**P.U. HT**  
**1,50 €**



Gobelet Vert

**1000386P** E Ø 8,4 x H. 9,2 cm - 27 cl



x 6

**P.U. HT**  
**1,50 €**





PICARDIE

**Campus** ARCOROC

En verre trempé.



<b>40128P</b>	E Ø 6,5 x H. 12,6 cm - 29 cl	x 6	<b>P.U.HT</b>		
<b>1797P</b>	E Ø 6,4 x H. 9,7 cm - 22 cl	x 6	<b>1,00 €</b>		
<b>1798P</b>	E Ø 6,5 x H. 8,8 cm - 18 cl	x 6	<b>0,81 €</b>		
			<b>0,75 €</b>		

**Picardie**

En verre trempé.



Gobelet forme basse

<b>1011238P</b>	E Ø 8,5 x H. 9 cm - 25 cl	x 6	<b>P.U.HT</b>		
<b>69319P</b>	E Ø 8 x H. 8,4 cm - 22 cl	x 6	<b>0,77 €</b>		
<b>69318P</b>	E Ø 7,5 x H. 7,8 cm - 16 cl	x 6	<b>0,81 €</b>		
<b>1013216P</b>	E Ø 6,5 x H. 6,7 cm - 9 cl	x 6	<b>0,63 €</b>		
			<b>0,57 €</b>		



Gobelet forme haute

<b>1011239P</b>	E Ø 8,8 x H. 12,5 cm - 36 cl	x 6	<b>P.U.HT</b>		
			<b>1,20 €</b>		

**Habana**

En verre trempé. Emboîtable



<b>65287P</b>	E Ø 7,7 x H. 8,2 cm - 22 cl	x 12	<b>P.U.HT</b>		
<b>65286P</b>	E Ø 7 x H. 7,5 cm - 17 cl	x 12	<b>0,77 €</b>		
			<b>0,64 €</b>		



HABANA

**Oxygen** ARCOROC

En verre trempé.



<b>55755P</b>	Ø 6,8 x H. 8,1 cm - 16 cl	x 6	<b>P.U.HT</b>		
			<b>0,65 €</b>		

**Forum** ARCOROC

En verre trempé.



<b>48627P</b>	E Ø 8,1 x H. 7,7 cm - 23 cl	x 6	<b>P.U.HT</b>		
<b>31709P</b>	E Ø 7,2 x H. 6,9 cm - 16 cl	x 6	<b>0,73 €</b>		
			<b>0,50 €</b>		

**Log** ARCOROC

En verre trempé.



<b>1011453P</b>	E Ø 7,3 x H. 7,9 cm - 22 cl	x 6	<b>P.U.HT</b>		
<b>1011454P</b>	E Ø 6,3 x H. 8 cm - 16 cl	x 6	<b>0,67 €</b>		
			<b>0,60 €</b>		



**Lyon**

En verre trempé.



<b>1793P</b>	E Ø 7,1 x H. 8,6 cm - 20 cl	x 24	<b>P.U.HT</b>		
<b>1794P</b>	E Ø 6,6 x H. 7,9 cm - 16 cl	x 6	<b>0,65 €</b>		
			<b>0,50 €</b>		

**Gigogne**

En verre trempé.



<b>69317P</b>	E Ø 8 x H. 7,7 cm - 22 cl	x 6	<b>P.U.HT</b>		
<b>69316P</b>	E Ø 7,1 x H. 6,9 cm - 16 cl	x 12	<b>0,63 €</b>		
			<b>0,45 €</b>		

**Norvège** ARCOROC

En verre trempé.



<b>31707P</b>	E Ø 7,2 x H. 8,8 cm - 20 cl	x 6	<b>P.U.HT</b>		
<b>31708P</b>	E Ø 6,5 x H. 8,2 cm - 16 cl	x 6	<b>0,60 €</b>		
			<b>0,48 €</b>		

Gobelets Trempé



ART DE LA TABLE

# ARCOROC



Bousculez les codes, initiez vos clients à de nouvelles expériences !

Mélange parfait de designs modernes et rétros inspirés par les bars branchés : ergonomiques, empilables, adaptés en termes de capacités pour un service parfait de cocktails, spiritueux, boissons gazeuses.

Au look d'un cristal ancien, Broadway est une collection remise au goût du jour qui s'inscrit dans la tendance du vintage-rétro. Les gobelets New York suivent cette même tendance.

Les 3 gobelets Fusion sont conçus pour une nouvelle dimension expérimentale des cocktails.

Improvisez-vous chimistes, mélangez les saveurs, les alcools et les fruits ; servez dans ces nouveaux écrins à cocktails !

## Rendez-vous

En Cristallin.



Gobelet forme haute			<b>P.U. HT</b>
<b>1011611</b>	Ø 8,35 x H. 12,95 cm - 36 cl	x 12	<b>4,80 €</b>
<b>1011613</b>	Ø 7,75 x H. 12,05 cm - 28 cl	x 12	<b>4,10 €</b>
Gobelet forme basse			
<b>1011612</b>	Ø 8,9 x H. 9,55 cm - 32 cl	x 12	<b>4,30 €</b>

## Broadway

En verre sodocalcique.



Gobelet forme haute			<b>P.U. HT</b>
<b>1011416P</b>	Ø 7,5 x H. 14,7 cm - 38 cl	x 6	<b>3,10 €</b>
<b>1011415P</b>	Ø 8,5 x H. 9,1 cm - 30 cl	x 6	<b>2,50 €</b>
Gobelet forme basse			
<b>1011417P</b>	Ø 6,7 x H. 13,4 cm - 28 cl	x 6	<b>2,50 €</b>

## Architecte

En Cristallin.



Gobelet forme haute			<b>P.U. HT</b>
<b>1011608</b>	Ø 10,8 x H. 12 cm - 28 cl	x 12	<b>4,10 €</b>
Gobelet forme basse			
<b>1011610</b>	Ø 8,45 x H. 12,95 cm - 36 cl	x 12	<b>4,90 €</b>
<b>1011609</b>	Ø 9,4 x H. 9,9 cm - 32 cl	x 12	<b>4,30 €</b>

nouveau !

## Mix and Co

En verre sodocalcique.



<b>1013214P</b>			<b>P.U. HT</b>
Ø 8,7 x H. 8,9 cm - 35 cl		x 6	<b>2,10 €</b>

## Macassar

En Cristallin.



Gobelet forme haute			<b>P.U. HT</b>
<b>1011647</b>	Ø 8,4 x H. 12,95 cm - 36 cl	x 12	<b>4,80 €</b>
<b>1011648</b>	Ø 7,83 x H. 12 cm - 28 cl	x 12	<b>4,10 €</b>
Gobelet forme basse			
<b>1011649</b>	Ø 9,9 x H. 10,45 cm - 38 cl	x 12	<b>4,80 €</b>

## Gem

En verre sodocalcique.



Gobelet forme haute			<b>P.U. HT</b>
<b>1002548P</b>	Ø 7,8 x H. 14 cm - 35 cl	x 6	<b>3,00 €</b>
Gobelet forme basse			
<b>1002547P</b>	Ø 9,3 x H. 8,5 cm - 32 cl	x 6	<b>3,00 €</b>



## LES ÉLÉGANTS



### Lima

En Krysta.



Gobelet forme haute

1011430

Ø 7,7 x H. 13 cm - 40 cl



x 24

P.U.HT

1,70 €



65371P

Ø 8,8 x H. 11 cm - 38 cl

x 6

1,70 €

### Linely

En Krysta.



Gobelet forme haute

1011419

Ø 7 x H. 17,5 cm - 45 cl



x 24

P.U.HT

1,90 €

1011421

Ø 6,3 x H. 15,7 cm - 33 cl

x 24

1,40 €

1011432

Ø 5,8 x H. 13,1 cm - 22 cl

x 24

1,40 €

Gobelet forme basse

1011423

Ø 8,9 x H. 9,6 cm - 38 cl

x 24

1,80 €

1011422

Ø 7 x H. 8,4 cm - 20 cl

x 24

1,30 €

### Vigne

En Krysta.



Gobelet forme haute

1007495P

Ø 7 x H. 16,5 cm - 45 cl



x 6

P.U.HT

1,70 €

1007468P

Ø 6,9 x H. 12,6 cm - 33 cl

x 6

1,30 €

Gobelet forme basse

1007467P

Ø 8,4 x H. 8,3 cm - 31 cl

x 6

1,50 €

1007469P

Ø 7,5 x H. 7,4 cm - 20 cl

x 6

1,30 €

### Véronèse

En SON.hyx.



Gobelet forme haute

49719P

Ø 6,9 x H. 15 cm - 31 cl



x 6

P.U.HT

4,20 €

Gobelet forme basse

49712P

Ø 8,3 x H. 9,1 cm - 26 cl

x 6

3,60 €

## LES RELIEFS



nouveau !

### Calypso

En verre sodocalcique.



Gobelet forme haute

1013440P

Ø 8,1 x H. 16 cm - 48 cl



x 6

P.U.HT

2,40 €

Gobelet forme basse

1013441P

Ø 8,2 x H. 10,6 cm - 35 cl

x 6

2,00 €

### Este

En verre sodocalcique.



Gobelet forme haute

1013003P

Ø 7,2 x H. 14 cm - 29 cl



x 6

P.U.HT

1,90 €

Gobelet forme basse

1012606P

Ø 8,9 x H. 10,7 cm - 40 cl

x 6

2,10 €

1013002P

Ø 8,5 x H. 8,95 cm - 30 cl

x 6

1,90 €



nouveau !

## Lounge

En verre sodocalcique.



1012607

Ø 8,9 x H. 10,7 cm - 40 cl



P.U.HT  
2,10 €

## Concerto

En verre sodocalcique, motif à losange.



Gobelet forme haute

69680P Ø 8,4 x H. 14 cm - 40 cl



P.U.HT  
2,50 €

Gobelet forme basse

68560P Ø 8,5 x H. 9 cm - 29 cl



2,30 €

## Honey

En verre sodocalcique, motif "nid d'abeille".



68561P

Ø 8,5 x H. 9 cm - 29 cl



P.U.HT  
2,30 €

## Dolomiti

En verre sodocalcique.



Gobelet forme haute

1010732P Ø 8,4 x H. 14 cm - 42 cl



P.U.HT  
2,20 €

Gobelet forme basse

1010731P Ø 8,7 x H. 9 cm - 29 cl



2,00 €

1013213P Ø 8 x H. 8,4 cm - 22 cl



2,00 €

## Diamond

En verre sodocalcique.



1005344P

Ø 8,4 x H. 9,3 cm - 30 cl



P.U.HT  
1,30 €

## Friends

En verre sodocalcique.



Gobelet forme haute

70184P Ø 8 x H. 13,9 cm - 34,4 cl



P.U.HT  
1,90 €

Gobelet forme basse

70183P Ø 8,8 x H. 9,8 cm - 31,5 cl



1,80 €

## Quartz

En verre sodocalcique.



Pailles et  
chalumeaux  
voir page 175



Gobelet forme haute

68207P Ø 6,7 x H. 15,6 cm - 30 cl



P.U.HT  
2,90 €

Gobelet forme basse

68265P Ø 8,5 x H. 9,5 cm - 25 cl



2,90 €

## Helsinki

En verre sodocalcique.



Gobelet forme haute

43489P Ø 7,7 x H. 14,3 cm - 32 cl



P.U.HT  
2,30 €

Gobelet forme basse

43488P Ø 8,9 x H. 9 cm - 27 cl



2,30 €

## Satellite

En verre sodocalcique.



Gobelet forme haute

1770P Ø 6,2 x H. 13,3 cm - 28 cl



P.U.HT  
1,50 €

Gobelet forme basse

1771P Ø 7,4 x H. 9,1 cm - 25 cl



1,50 €

## LES RELIEFS EFFET GIVRÉ





TIKI PINEAPPLE



TIKI ROCK



MOSCOW MULE

LES DÉTOURNÉS DU BAR

nouveau !

**Tiki Pineapple**

En verre sodocalcique.



Gobelet  
**1012710P** Ø 7 x H. 14 cm - 48 cl x 12

P.U.HT  
**4,90 €**

**Tiki Rock**

En verre sodocalcique.



Gobelet  
**1013156P** Ø 7 x H. 11,7 cm - 47,3 cl x 12

P.U.HT  
**4,40 €**

**Moscow Mule**

Inox. Finition cuivrée, anses en zinc.



Mug  
**1013246P** Ø 9,2 x H. 9,2 cm - 47,3 cl x 12

P.U.HT  
**14,70 €**

**Quattro stagioni**

En verre. Pour une présentation originale des boissons. Avec bouchon à vis.



Bouteille  
**1007028P** Ø 7,3 x H. 15,5 cm - 40 cl x 12  
**1007027P** Ø 6,4 x H. 11,6 cm - 20 cl x 12

P.U.HT  
**1,80 €**



Bock avec anse  
**1007032P** Ø 8,5 x H. 13,6 cm - 41,5 cl  
**1009141** Ø 9,65 x H. 14,6 cm - 75 cl

P.U.HT  
**2,20 €**



Couvercle inox perforé pour bock **1007032P**  
**1011401P** Ø 7 cm x 1  
**1,60 €**





**SKULL**



**FLUID**



**FUSION**

**nouveau !**

**Skull**

En verre sodocalcique.

90 cl



Contenant cocktail à partager

**1013294** Ø 16,4 x H. 16 cm - 90 cl



x 4

**P.U.HT**

**8,00 €**

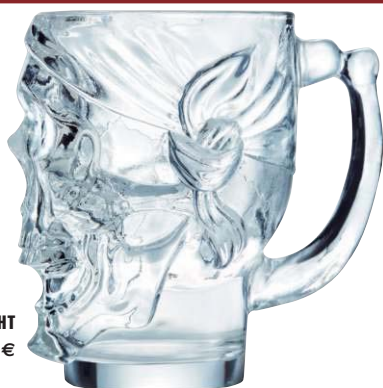

**BE BOP**

VERRES DE BAR

**Fusion**

En verre sodocalcique.

ARCOROC



**1011442P** Ø 8,2 x H. 12 cm - 35 cl



x 6

**P.U.HT**

**1,30 €**

**Be Bop**

En verre trempé.

ARCOROC **EXTRA RESISTANT**



Gobelet forme haute

**1011433P** Ø 6,9 x H. 14,2 cm - 35 cl

Gobelet forme basse

**1011434P** Ø 8,4 x H. 8,2 cm - 30 cl

**1013247P** Ø 8,2 x H. 5,9 cm - 21 cl



x 6

**P.U.HT**

**0,97 €**

x 6

**0,96 €**

x 6

**0,89 €**

**Fluid**

En verre sodocalcique.

ARCOROC



**1008354P** E Ø 7,1 x H. 13,5 cm - 25 cl

**1008353P** Ø 6 x H. 11,3 cm - 12,5 cl



x 12

**P.U.HT**

**2,50 €**

x 12

**1,50 €**

**Eskale**

En verre trempé.

ARCOROC **EXTRA RESISTANT**

Pailles  
Voir page 233



**1008020P** E Ø 9,7 x H. 9,6 cm - 42 cl

**1008021P** E Ø 9 x H. 8,7 cm - 31 cl



x 6

**P.U.HT**

**1,30 €**

x 6

**1,20 €**

ART DE LA TABLE



GRANITY

STACK UP

NEW YORK

## Granity

En verre trempé.

ARCOROC  



### Gobelet forme haute

	50005P	Ø 8,7 x H. 16 cm - 46 cl	x 12	<b>P.U.HT</b>	<b>1,90 €</b>
✓	40129P	Ø 8,5 x H. 12,2 cm - 35 cl	x 12	<b>1,20 €</b>	
✓	40130P	Ø 7,5 x H. 14 cm - 31 cl	x 12	<b>1,20 €</b>	

### Gobelet forme basse

	1011451P	Ø 9,2 x H. 10,7 cm - 35 cl	x 6	<b>P.U.HT</b>	<b>1,20 €</b>
✓	43490P	Ø 8,5 x H. 9,8 cm - 27 cl	x 12	<b>0,94 €</b>	
✓	43491P	Ø 8 x H. 8,1 cm - 20 cl	x 12	<b>0,96 €</b>	
✓	51113P	Ø 7,3 x H. 7,3 cm - 16 cl	x 12	<b>0,78 €</b>	

## Stack Up

En verre trempé.

ARCOROC  



### Gobelet forme haute

	1000527P	Ø 8,3 x H. 14,4 cm - 40 cl	x 6	<b>P.U.HT</b>	<b>1,80 €</b>
	1000528P	Ø 7,8 x H. 14 cm - 35 cl	x 6	<b>1,80 €</b>	
	1000529P	Ø 7,6 x H. 11,9 cm - 29 cl	x 6	<b>1,30 €</b>	

### Gobelet forme basse

	1000530P	Ø 9,2 x H. 9,2 cm - 32 cl	x 12	<b>P.U.HT</b>	<b>1,30 €</b>
	1002654P	Ø 8,5 x H. 9,2 cm - 26 cl	x 6	<b>0,98 €</b>	
✓	1001449P	Ø 8,3 x H. 8 cm - 21 cl	x 6	<b>1,20 €</b>	

## New york

En verre trempé.

ARCOROC  

**nouveau !**



Gobelet forme haute  
**1013248P** Ø 7,8 x H. 15,6 cm - 40 cl x 6 **P.U.HT** **1,40 €**



### Gobelet forme haute

	<b>1011447P</b>	Ø 7,4 x H. 14,4 cm - 35 cl	x 6	<b>P.U.HT</b>	<b>1,40 €</b>
--	-----------------	----------------------------	-----	---------------	---------------

# LES FONDAMENTAUX

## Stockholm

En verre sodocalcique.



Gobelet forme haute

**43486P** Ø 7,7 x H. 14,3 cm - 32 cl



x 6 **P.U.HT**  
**2,10 €**

Gobelet forme basse

**43485P** Ø 8,9 x H. 9 cm - 27 cl



x 6 **P.U.HT**  
**2,10 €**

nouveau !

## Martiques

En verre sodocalcique.

ARCOROC

Jaugé à ~ 2 cl



**1013049P** Ø 6,9 x H. 15,1 cm - 16 cl



x 12 **P.U.HT**  
**0,96 €**

## Conique

En verre trempé.

ARCOROC EXTRA RESISTANT



**61562P** Ø 7 x H. 11,6 cm - 28 cl  
**61561P** Ø 6,8 x H. 10,7 cm - 25 cl



x 6 **P.U.HT**  
**0,89 €**  
x 6 **0,86 €**

## Disco

En verre sodocalcique.



Gobelet forme haute

**35711P** Ø 6,8 x H. 14 cm - 34 cl



x 6 **P.U.HT**  
**1,90 €**

**43482P** Ø 5,7 x H. 15,9 cm - 27 cl



x 6 **P.U.HT**  
**1,70 €**

Gobelet forme basse

**35712P** Ø 7,6 x H. 9,3 cm - 26 cl



x 6 **P.U.HT**  
**1,70 €**

**35713P** Ø 6,9 x H. 8,5 cm - 21 cl



x 6 **P.U.HT**  
**1,80 €**

## Prysm

En verre trempé.

ARCOROC EXTRA RESISTANT



**62409P** Ø 9,4 x H. 8,8 cm - 27 cl



x 12 **P.U.HT**  
**1,20 €**

## Islande

En verre sodocalcique.

ARCOROC



Chope

**31687P** Ø 6,3 x H. 15,7 cm - 33 cl



x 12 **P.U.HT**  
**0,85 €**

**51094P** Ø 6 x H. 16,6 cm - 31 cl



x 6 **0,80 €**

**1763P** Ø 6,3 x H. 14,5 cm - 29 cl



x 12 **0,76 €**

**31689P** Ø 5,8 x H. 13,1 cm - 22 cl



x 12 **0,71 €**

**1765P** Ø 5,6 x H. 10 cm - 16 cl



x 6 **0,62 €**

Gobelet tubo

**1764P** Ø 5,3 x H. 15,2 cm - 22 cl



x 12 **P.U.HT**  
**0,71 €**

**40108P** Ø 5,2 x H. 12,5 cm - 17 cl



x 24 **0,85 €**

**51117P** Ø 5,1 x H. 8,7 cm - 10 cl



x 24 **0,69 €**

## Scotch

En verre sodocalcique.



**31703P** Ø 6,2 x H. 12,3 cm - 25 cl  
**43480P** Ø 6,15 x H. 10,8 cm - 21 cl



x 6 **P.U.HT**  
**1,80 €**  
x 6 **1,60 €**

## Shetland

En verre sodocalcique.

ARCOROC



Gobelet forme haute

**57110P** Ø 7,3 x H. 12,3 cm - 22 cl



x 12 **P.U.HT**  
**1,20 €**

Gobelet forme basse

**57500P** Ø 9 x H. 8,8 cm - 25 cl



x 12 **P.U.HT**  
**1,30 €**

Gobelet forme basse

**1767P** Ø 7,9 x H. 9,3 cm - 30 cl  
**31688P** Ø 7 x H. 8,4 cm - 20 cl



x 48 **P.U.HT**  
**0,91 €**  
x 12 **0,68 €**



COCKTAIL

**Taverne**

En verre sodocalcique.



**2701P** Ø 9,8 x H. 15 cm - 48 cl x 6 **P.U.HT 5,40 €**

**Jockey Club**

En verre sodocalcique.



**55672P** Ø 9,4 x H. 14,1 cm - 14 cl x 6 **P.U.HT 4,30 €**

nouveau !

**Michelangelo**

En sparkx.



**1013243P** Ø 9,55 x H. 14 cm - 22,5 cl x 6 **P.U.HT 3,30 €**

**Cabernet**

En Krysta.



**53580P** Ø 12 x H. 18,8 cm - 30 cl x 24 **P.U.HT 4,70 €**  
**53579P** Ø 11,6 x H. 17,2 cm - 21 cl x 24 **P.U.HT 4,30 €**

**Hawai**

En verre sodocalcique.



**63534P** Ø 8,6 x H. 21,5 cm - 44 cl x 6 **P.U.HT 4,60 €**

nouveau !

**Héritage**

En verre sodocalcique.



**1013150P** Ø 11 x H. 13,2 cm - 26 cl x 6 **P.U.HT 3,10 €**

**Cabernet**

En Krysta.



**62710P** Ø 12 x H. 17 cm - 30 cl x 6 **P.U.HT 4,10 €**

**Charente**

En verre sodocalcique.



**40009P** Ø 9,7 x H. 18,4 cm - 51 cl x 6 **P.U.HT 3,80 €**

**Hurricane**

En verre sodocalcique.



**57164P** Ø 7,9 x H. 20,8 cm - 44 cl x 12 **P.U.HT 3,70 €**  
**57163P** Ø 7,1 x H. 19,5 cm - 25 cl x 12 **P.U.HT 3,30 €**

**New Martini**

En Krysta.



**1008178P** Ø 11,4 x H. 17,9 cm - 21 cl x 6 **P.U.HT 3,70 €**

**Margarita**

En verre sodocalcique.



**1005728P** Ø 10,8 x H. 16 cm - 27 cl x 6 **P.U.HT 3,40 €**

**Kyoto**

En verre sodocalcique.



**1000536P** Ø 8,1 x H. 17,9 cm - 31 cl x 6 **P.U.HT 3,10 €**

**Cabernet**

En Krysta.



**1008177P** Ø 7,4 x H. 17,2 cm - 35 cl x 6 **P.U.HT 3,00 €**

**Bacchus**

En verre sodocalcique.



**40011P** Ø 8,7 x H. 15,8 cm - 36 cl x 12 **P.U.HT 2,60 €**

**Sambaya**

En verre sodocalcique.



**54318P** Ø 9,4 x H. 13,2 cm - 40 cl x 6 **P.U.HT 2,40 €**



## Open up Arabesque

En Krysta.

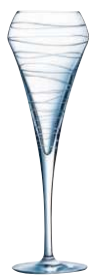

Ø 7,4 x H. 23,4 cm - 20 cl

70210P



x 4 P.U.HT 5,80 €

## Reveal up

En Krysta.



Ø 6,5 x H. 23 cm - 21 cl

1006219P



x 6 P.U.HT 4,90 €

## Open up

En Krysta.



Ø 7,4 x H. 23,4 cm - 20 cl

59490P



x 6 P.U.HT 4,70 €

## œnologie expert

En Krysta.



Ø 7,1 x H. 21,5 cm - 26 cl

62404P



x 6 P.U.HT 3,90 €

## Macaron

En Krysta.



Ø 8,1 x H. 19,5 cm - 30 cl

1011428P



x 6 P.U.HT 4,90 €

nouveau !

## Macaron Fascination

En Krysta.



Ø 9,5 x H. 19,1 cm - 30 cl

1013253P



x 6 P.U.HT 4,00 €

## Arom up

En Krysta.



Ø 7,4 x H. 21,1 cm 21 cl

65359P



x 12 P.U.HT 2,70 €

## Uno

En Star Glass.



Ø 6,7 x H. 24,3 cm - 28 cl

1005326



x 12 P.U.HT 3,80 €

## Aurum

En Star Glass.



Ø 6,8 x H. 23,5 cm - 23 cl

59514P



x 6 P.U.HT 3,10 €

## Dream

En Sparkx.



Ø 6 x H. 19 cm - 14,2 cl

69203P



x 6 P.U.HT 3,00 €

## Michelangelo

En Sparkx.



Ø 6,4 x H. 18,5 cm - 16 cl

1478P



x 6 P.U.HT 2,90 €

## Sublym

En Krysta.



Ø 6,5 x H. 24 cm - 21 cl

1007734



x 6 P.U.HT 2,80 €

## Ypsilon

En verre sodocalcique.



Ø 5,7 x H. 19,5 cm - 11 cl

65304P



x 12 P.U.HT 2,70 €

## Allegro

En verre sodocalcique.



Ø 5,5 x H. 22,4 cm - 16 cl

69664P



x 12 P.U.HT 2,20 €

## Brio

ARCOROC

En verre sodocalcique.



Ø 6,5 x H. 19,8 cm - 16 cl

1001634P



x 6 P.U.HT 2,10 €

Ø 5,6 x H. 17,1 cm - 9,5 cl

1000577P



x 6 P.U.HT 2,10 €

## Bubble

En verre sodocalcique.



Ø 4,9 x H. 16,3 cm - 15 cl

69665P



x 6 P.U.HT 2,00 €

## Coupe unie Champagne

La Rochère

En verre sodocalcique.



Ø 10,8 x H. 9,7 cm - 22 cl

47350P



x 6 P.U.HT 2,30 €

## Coupe ballon

ARCOROC

En verre sodocalcique.



Ø 8,8 x H. 10,4 cm - 13 cl

1534P



x 12 P.U.HT 1,10 €

OPEN UP SPIRIT



BROADWAY



DÉGUSTATION

Open Up Spirit

En Krysta.



Verre à pied ardent  
 65357P Ø 10,4 x H. 13,2 cm - 39 cl x 6 P.U.HT 6,90 €



Verre à pied ambiant  
 63531P Ø 7 x H. 17 cm - 16,5 cl x 6 P.U.HT 5,30 €



Gobelet warm  
 63529P Ø 9,9 x H. 8,6 cm - 30 cl x 6 P.U.HT 4,70 €

Macassar

En Cristallin.



1011650 Ø 4,9 x H. 7,85 cm - 6 cl x 12 P.U.HT 2,20 €

Disco

En verre sodocalcique.



57111P Ø 4,5 x H. 6,7 cm - 5 cl x 6 P.U.HT 1,10 €

Broadway

En verre sodocalcique.



1011418P Ø 4,9 x H. 5,95 cm - 5 cl x 6 P.U.HT 1,60 €

Verre à alcool

En verre sodocalcique.



Filet or, jaugé à 1,5 cl  
 2022P Ø 4,5 x H. 8 cm - 3 cl x 12 P.U.HT 3,50 €



31678 Ø 3,6 x H. 8 cm - 3 cl x 12 P.U.HT 2,70 €  
 2024 Ø 3,6 x H. 6,5 cm - 2 cl x 12 P.U.HT 2,40 €

Dublino

En verre trempé.



51601P Ø 4,5 x H. 7 cm - 3,4 cl x 6 P.U.HT 0,90 €

Dégustation

En verre sodocalcique.



Verre à cognac  
 53585P Ø 9,5 x H. 12,9 cm - 41 cl x 6 P.U.HT 2,30 €  
 2017P Ø 8,2 x H. 11,2 cm - 25 cl x 12 P.U.HT 2,00 €  
 2018P Ø 6,7 x H. 9,6 cm - 15 cl x 12 P.U.HT 1,70 €

Vigne

En verre sodocalcique.



51091P Ø 5,4 x H. 14,5 cm - 7 cl x 12 P.U.HT 2,40 €

Gem

En verre sodocalcique.



1011175P Ø 7,1 x H. 6,5 cm - 12 cl x 6 P.U.HT 1,40 €

Quartz

En verre sodocalcique.



59542P Ø 5,6 x H. 6,5 cm - 7 cl x 6 P.U.HT 1,40 €

Gin

En verre sodocalcique.



50006P Ø 4,2 x H. 5,2 cm - 3 cl x 24 P.U.HT 0,48 €





## Dortmund

En verre sodocalcique.



✓ **40127P** Ø 7,6 x H. 24,3 cm - 37 cl x 12 **P.U.HT**  
**3,70 €**

## Exécutive

En verre sodocalcique.



✓ **65386P** Ø 8 x H. 18,6 cm - 39 cl x 6 **P.U.HT**  
**2,60 €**

## Picardie

En verre trempé.



**1011239P** E Ø 8,8 x H. 12,5 cm - 36 cl x 6 **P.U.HT**  
**1,20 €**

## Harmonia

En verre sodocalcique.



**1013165P** Ø 8,4 x H. 21,3 cm - 58 cl x 6 **P.U.HT**  
**3,40 €**  
✓ **56189P** Ø 7,3 x H. 20,1 cm - 38,5 cl x 6 **3,00 €**  
✓ **56188P** Ø 6,7 x H. 18,6 cm - 27,5 cl x 6 **2,70 €**

## Ultimate Pint

En verre trempé.



**70443P** Ø 9 x H. 16 cm - 57 cl x 24 **P.U.HT**  
**1,20 €**

## Périgord

En verre pressé sodocalcique.



✓ **1007406P** Ø 8 x H. 16,8 cm - 38 cl x 6 **P.U.HT**  
**2,70 €**

## Nonic

En verre trempé.



✓ **57109P** Ø 8,7 x H. 15,2 cm - 57 cl x 48 **P.U.HT**  
**1,10 €**  
✓ **50144P** Ø 7,3 x H. 11,5 cm - 28 cl x 48 **0,90 €**

## ACCESSOIRES

### Sous-verre

En ouate.

Possibilité de personnalisation.  
Nous consulter



7 épaisseurs - Paquet de 1000 **P.U.HT**  
**59710P** Ø 9,5 cm x 1 **40,50 €**

8 épaisseurs - Paquet de 1000 **P.U.HT**  
**59712P** Ø 9 cm x 1 **27,25 €**



Verre

En copolyester Tritan transparent. Garanti 2 000 lavages jusqu'à 100°C.

Sans Bisphénol A



Verre à pied  
**A 1011443** Ø 7,5 x H. 21,5 cm - 45 cl x 6 **P.U.HT 4,70 €**  
**B 1011444P** Ø 8 x H. 22 cm - 60 cl x 6 **P.U.HT 4,70 €**



Tumbler  
**1003072P** Ø 6 x H. 14,5 cm - 27 cl x 6 **P.U.HT 3,10 €**



Graniti XL  
**1003063P** Ø 8,5 x H. 14,6 cm - 50 cl x 6 **P.U.HT 2,30 €**



Verre à pied  
**1006215P** Ø 7 x H. 17 cm - 19 cl x 6 **P.U.HT 2,90 €**



Flûte  
**1006218P** Ø 5,2 x H. 19,05 cm - 13 cl x 6 **P.U.HT 2,90 €**



Graniti - Ø 8,4 x H. 12 cm - 35 cl  
**1006217P** Transparent x 6 **P.U.HT 2,50 €**  
**1003055** Blanc x 6 **P.U.HT 2,70 €**

Gobelet  
**A 1011593P** Ø 8,4 x H. 10 cm - 27 cl x 6 **P.U.HT 2,00 €**  
**B 1011445P** Ø 4,9 x H. 14,9 cm - 22 cl x 6 **P.U.HT 2,00 €**

Gobelet

En copolyester.

Sans Bisphénol A



Transparent  
**34226P** Ø 6,3 x H. 8,5 cm - 16 cl x 24 **P.U.HT 2,30 €**  
**34227P** Ø 6,9 x H. 8 cm - 20 cl x 48 **P.U.HT 2,40 €**

Gobelet

En copolyester.

Sans Bisphénol A



Bleu  
**70761P** E Ø 6,2 x H. 7,7 cm - 16 cl x 10 **P.U.HT 2,10 €**  
**70767P** E Ø 6,9 x H. 8 cm - 20 cl x 10 **P.U.HT 2,20 €**



Vert  
**70765P** E Ø 6,2 x H. 7,7 cm - 16 cl x 10 **P.U.HT 2,10 €**  
**70771P** E Ø 6,9 x H. 8 cm - 20 cl x 10 **P.U.HT 2,20 €**



Transparent  
**70766P** E Ø 6,2 x H. 7,7 cm - 16 cl x 10 **P.U.HT 2,20 €**  
**70760P** E Ø 6,9 x H. 8 cm - 20 cl x 10 **P.U.HT 2,10 €**



Jaune  
**70763P** E Ø 6,2 x H. 7,7 cm - 16 cl x 10 **P.U.HT 2,10 €**  
**70769P** E Ø 6,9 x H. 8 cm - 20 cl x 10 **P.U.HT 2,20 €**



Orange  
**70764P** E Ø 6,2 x H. 7,7 cm - 16 cl x 10 **P.U.HT 2,10 €**  
**70770P** E Ø 6,9 x H. 8 cm - 20 cl x 10 **P.U.HT 2,20 €**







Pailles noires

Paquet de 250  **P.U.HT**  
 ✓ **1000380P** Ø 6 mm x H. 21 cm x 1 **2,40 €**



Pailles Mojito noires

Paquet de 500  **P.U.HT**  
 ✓ **1002348P** Ø 6 mm x H. 10 cm x 1 **4,00 €**



Pailles unies panachées

Paquet de 500  **P.U.HT**  
 ✓ **65098P** Ø 6 mm x H. 21 cm x 1 **4,60 €**

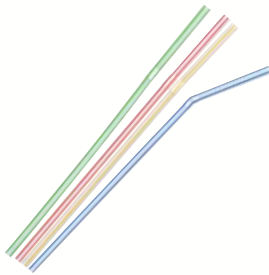

Pailles striées sous emballage individuel

Paquet de 500  **P.U.HT**  
 ✓ **1011563P** Ø 0,5 mm x H. 20 cm x 1 **8,10 €**



Pailles Mojito transparentes

Paquet de 500  **P.U.HT**  
 ✓ **1007692P** Ø 6 mm x H. 10 cm x 1 **4,00 €**



Pailles palmier articulées

Paquet de 100  **P.U.HT**  
 ✓ **61335P** Ø 5 mm x H. 24 cm x 1 **8,80 €**



Pailles satinées, coloris panachés  
Rose, bleu, ivoire et gris perlé

Paquet de 500  **P.U.HT**  
 ✓ **68313P** Ø 5 mm x H. 24 cm x 1 **5,00 €**

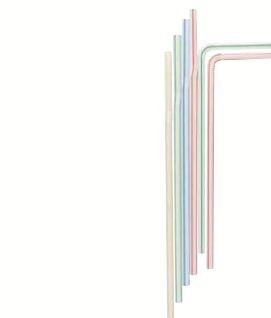

Pailles rayées 4 couleurs

Paquet de 500  **P.U.HT**  
 ✓ **1000006P** Ø 5 mm x H. 21 cm x 1 **5,40 €**



Pailles smoothies transparentes

Paquet de 250  **P.U.HT**  
 ✓ **1006554P** Ø 7,5 mm x H. 21,5 cm x 1 **2,80 €**



Pailles bicolores noir/blanc articulées

Paquet de 500  **P.U.HT**  
 ✓ **1002351P** Ø 5 mm x H. 24 cm x 1 **5,90 €**

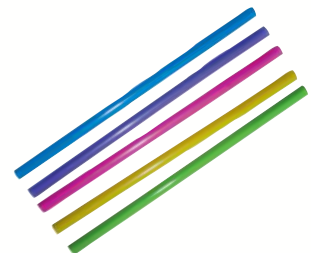

Spécial boissons granitées

Paquet de 500  **P.U.HT**  
 ✓ **1002349P** Ø 8 mm x H. 21 cm x 1 **8,10 €**



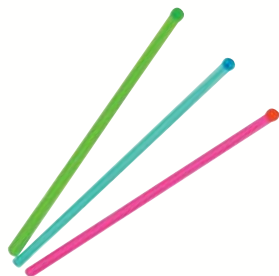

Batteurs couleurs

Paquet de 500  **P.U.HT**  
**1006460P** H. 16,5 cm x 1 **17,50 €**



Batteurs hippocampe couleurs

Paquet de 100  **P.U.HT**  
**61340P** H. 15,5 cm x 1 **14,70 €**



Batteurs disques couleurs

Paquet de 100  **P.U.HT**  
**1000010P** H. 17 cm x 1 **14,60 €**



Batteurs palmier couleurs

Paquet de 100  **P.U.HT**  
**1000011P** H. 18 cm x 1 **13,70 €**



Batteurs disque noirs

Paquet de 250  **P.U.HT**  
 **1004334P** H. 18 cm x 1 **12,70 €**

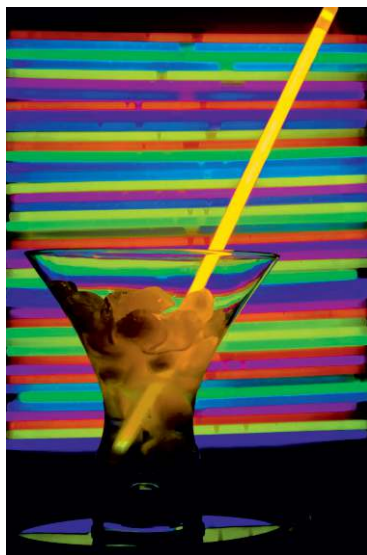

Batteurs / bracelets fluo  
 Rouge, jaune, bleu, vert, rose

Paquet de 100  **P.U.HT**  
**68311P** Ø 5 mm x H. 21 cm x 1 **19,25 €**



Batteurs noirs

Paquet de 1000  **P.U.HT**  
**1007703P** H. 15,3 cm x 1 **37,75 €**

## Décoration

Idéal pour décorer vos glaces ou cocktails.



A



B



C



D

<b>65094P</b>	A - Palmier L. 16 cm Boîte de 100	 x 1	<b>P.U.HT</b> <b>6,50 €</b>
<b>65093P</b>	B - Ombrelle L. 10 cm Boîte de 144	 x 1	<b>6,60 €</b>
<b>1006473</b>	C - Soleil L. 11 cm Boîte de 144	 x 20	<b>5,60 €</b>
<b>1006475</b>	D - Palmier fruit L. 15 cm Boîte de 100	 x 20	<b>7,00 €</b>

## Portionneuse à glace

En inox.

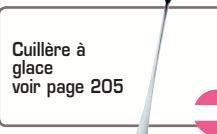

Cuillère à  
 glace  
 voir page 205



<b>56450P</b>	Boule ronde 12 parts/L	 x 1	<b>P.U.HT</b> <b>58,00 €</b>
<b>1007125P</b>	Boule ronde 24 parts/L	 x 1	<b>58,50 €</b>



 <b>56449P</b>	A conduction thermique Boule ronde 24 parts/L	 x 1	<b>P.U.HT</b> <b>33,75 €</b>
---	--	---	---------------------------------





<b>69365P</b>	Boule ovale 30 parts/L	 x 1	<b>P.U.HT</b> <b>12,10 €</b>
---------------	------------------------	---	---------------------------------



 <b>4198</b>	Boule ronde 36 parts/L	 x 10	<b>P.U.HT</b> <b>13,70 €</b>
---	------------------------	--	---------------------------------



 <b>67667P</b>	Boule ronde 16 parts/L	 x 1	<b>P.U.HT</b> <b>13,10 €</b>
<b>67666P</b>	Boule ronde 24 parts/L	 x 1	<b>13,10 €</b>

nouveau !

## Baya

En verre sodocalcique.



Ø 12 x H. 10,5 cm - 40 cl

**1013101P** Ambre  
**1005619P** Vert  
**1012709P** Parme

**P.U.HT**  
x 4 **4,20 €**  
x 4 **4,20 €**  
x 4 **4,20 €**



# BAYA

## Hypinox

En inox.



**1001368P** Ø 14 x H. 5 cm



**P.U.HT**  
x 1 **9,60 €**

## Coupe sur pied

En inox.



**1001618P** Ø 11,5 x H. 12 cm - 40 cl  
**1003642P** Ø 10 x H. 9,5 cm - 25 cl



**P.U.HT**  
x 6 **10,90 €**  
x 12 **7,10 €**

## Coupe conique

En inox.



**1003640P** Ø 12 x H. 8 cm - 40 cl  
**1003641P** Ø 10 x H. 8 cm - 25 cl



**P.U.HT**  
x 12 **9,00 €**  
x 12 **5,90 €**

## Coupe

En inox.



**67633P** Ø 9 cm - 14,8 cl

**P.U.HT**  
x 12 **3,30 €**

## Jazzed

En verre sodocalcique.

ARCOROC



**A 1011483P** Frozen Ø 12,3 x H. 19,8 cm - 41 cl x 6 **4,90 €**  
**B 1011482P** Swirl Ø 13,4 x H. 8,6 cm - 25 cl x 6 **3,30 €**

**P.U.HT**

## Jazz

En verre sodocalcique.

ARCOROC



**A 64276P** Ø 12,3 x H. 19,8 cm - 41 cl x 6 **4,80 €**  
**B 1001276P** Ø 15,5 x H. 13,3 cm - 25 cl x 6 **3,30 €**

**P.U.HT**

## Fortuna

En verre sodocalcique.



**54227P** Ø 12,5 x H. 18 cm - 32 cl x 6 **5,30 €**

**P.U.HT**

## Palmier

En verre sodocalcique.

ARCOROC



**A 52314P** Ø 12 x H. 20,1 cm - 37 cl x 6 **4,90 €**  
**B 52311P** Ø 12,5 x H. 10,1 cm - 21 cl x 6 **3,20 €**

**P.U.HT**

## Circée

En verre pressé transparent.

La Rochère



**A 69727P** Ø 11,6 x H. 16,9 cm - 27 cl x 6 **4,20 €**  
**B 1002750P** Ø 14 x H. 11 cm - 24,5 cl x 6 **3,30 €**

**P.U.HT**

## Antillaise

En verre sodocalcique.

La Rochère



**2088P** Ø 8,2 x H. 18,4 cm - 29 cl x 6 **4,00 €**

**P.U.HT**



nouveau !

**Bali**

En verre sodocalcique pressé.

La Rochère



1013110 E Ø 25,5 x H. 3,9 cm - 30 cl x 6

P.U.HT  
2,60 €**Ypsilon**

En verre sodocalcique.



71210P Ø 13 x H. 9 cm - 37,5 cl x 6

P.U.HT  
3,50 €**Sunday**

En verre sodocalcique.

La Rochère



2093P E Ø 9,5 x H. 12 cm - 20 cl

P.U.HT  
2,80 €**Max**

En verre sodocalcique.



A



B

A 70191P Ø 8,1 x H. 16,5 cm - 34,5 cl x 6  
B 70192P Ø 9,3 x H. 12 cm - 29 cl x 6P.U.HT  
3,80 €  
1,70 €**Acapulco**

En verre sodocalcique.



1001386P Ø 11,6 x H. 12,5 cm - 30 cl x 6

P.U.HT  
3,30 €**Fidji**

En verre sodocalcique.

La Rochère



2095P Ø 10 x H. 15,3 cm - 20 cl

P.U.HT  
2,50 €**Volubis**

En verre sodocalcique.



64593P Ø 12 x H. 9 cm - 33 cl x 6

P.U.HT  
3,80 €**Spirit**

En verre pressé sodocalcique.

La Rochère



1007404 Ø 13,6 x H. 11,4 cm - 22 cl x 6

P.U.HT  
2,90 €**Boléro**

En verre sodocalcique brillant.



40135P Ø 10,3 x H. 9,2 cm - 22 cl x 6

P.U.HT  
2,40 €

nouveau !

**Milord**

En verre sodocalcique.



1013151P Ø 9,65 x H. 12,6 cm - 35 cl x 6

P.U.HT  
2,40 €**Etoire**

En verre sodocalcique.



1007764P Ø 11 x H. 11,2 cm - 36 cl x 6

P.U.HT  
2,80 €**Tahiti**

En verre sodocalcique.

La Rochère



2101P E Ø 10 x H. 8,2 cm - 23 cl x 6

P.U.HT  
2,40 €

## Oséo

En verre sodocalcique.



1005491P E L. 11 x l. 11 x H. 9,3 cm - 39,7 cl

x 6

P.U.HT  
2,10 €

## Canaries

En verre sodocalcique.

La Rochère



2102P E Ø 9 x H. 8,5 cm - 13 cl

x 6

P.U.HT  
1,70 €

## Maéva

En verre sodocalcique.

ARCOROC



1011488P Ø 12 x H. 7,4 cm - 35 cl  
1011489P Ø 10 x H. 6,2 cm - 20 cl

x 6  
x 6

P.U.HT  
1,50 €  
1,40 €

## Carat

En verre sodocalcique.

La Rochère



63504P E Ø 8 x H. 8,6 cm - 19 cl

x 6

P.U.HT  
2,00 €

## Vega

En verre sodocalcique.

La Rochère



42005P E Ø 9,2 x H. 7,8 cm - 15 cl

x 6

P.U.HT  
1,70 €

## Coupe cafétéria unie

En verre sodocalcique.

La Rochère



49249P Ø 13 x H. 6 cm - 25 cl

x 6

P.U.HT  
1,40 €

## Sweet

En verre pressé sodocalcique.

La Rochère



1010730P E Ø 10,4 x H. 5,4 cm - 25 cl

x 6

P.U.HT  
1,90 €

## Diamond

En verre sodocalcique.



1007477P Ø 11 x H. 6 cm - 22 cl

x 12

P.U.HT  
1,70 €

## Pépite

En verre sodocalcique. Empilable.

ARCOROC



55757P E Ø 10,8 x H. 6 cm - 20 cl

x 6

P.U.HT  
1,40 €

## Bubble

En verre sodocalcique.

La Rochère



65315P E Ø 12 x H. 9 cm - 13 cl

x 6

P.U.HT  
1,80 €

## 1<sup>er</sup> PRIX

### Cyclade

En verre sodocalcique.



69434P E Ø 10,3 x H. 7,9 cm - 19,7 cl

x 4

P.U.HT  
1,70 €

### Ondine

En verre trempé.



69323P E Ø 11 x H. 5,2 cm - 23,5 cl

x 6

P.U.HT  
0,90 €



# COUZON



9<sup>ème</sup> Art > Page 185



Alkaline > Page 185



Pixelle 3D > Page 186



Millénium > Page 186



Héritage > Page 194



Ezzo > Page 187



Lazzo > Page 187



Guest Vintage > Page 189



Blois > Page 189



Marquise > Page 194



Anzo > Page 183



Rubis > Page 183



Alinéa > Page 190



Galaxy > Page 190



Alaska > Page 191



Arcade > Page 195



Anser > Page 195



Ingres > Page 199



Eco Baguette > Page 199



Fjord > Page 199



Frida > Page 199



Settecento > Page 194





Wave ciselé > Page 192



Wave > Page 192



Orenok > Page 193



Izia > Page 193



Vieux Paris PM > Page 196



Arobase > Page 197

TB



Style 180 > Page 198



Amande > Page 201



Baguette PM > Page 196



Carlton > Page 197



Trilogy > Page 198



Aztek > Page 198



Adagio > Page 202



Octave > Page 204



Eco max > Page 204



Vieux paris > Page 204



Baltik > Page 204



Eco > Page 205



Couverts spécifiques > Page 201



Couteaux à steak > Page 202



Couverts de spécialités > Page 205



Accessoires couverts > Page 205





### Stone Washed

Donnez un aspect "vintage" à vos tables. Choisissez le modèle qui vous plaît parmi les collections **Eternum** et nous faisons le reste.

**eternum**   
created 1924



nouveau !

## Anzo

Épaisseur 4,1 mm. Finition poli-miroir.

eternum depuis 1924 INOX 18/10



Couteau ergonomique



		☐	P.U.HT
<b>1013102</b>	Cuillère de table	x 12	<b>3,90 €</b>
<b>1013103P</b>	Fourchette de table	x 12	<b>3,90 €</b>
<b>1013104P</b>	Couteau de table monobloc cranté	x 12	<b>4,80 €</b>
<b>1013105</b>	Couteau de table ergonomique monobloc cranté	x 12	<b>5,20 €</b>
<b>1013109P</b>	Cuillère à café	x 12	<b>2,00 €</b>
<b>1013106P</b>	Cuillère à dessert	x 12	<b>3,20 €</b>
<b>1013107</b>	Fourchette à dessert	x 12	<b>3,10 €</b>
<b>1013108</b>	Couteau à dessert ergonomique monobloc cranté	x 12	<b>4,70 €</b>

## Rubis

Forgé. Finition poli-miroir.

eternum depuis 1924 INOX 18/10



		☐	P.U.HT
<b>1006177</b>	Cuillère de table	x 12	<b>7,70 €</b>
<b>1006178</b>	Fourchette de table	x 12	<b>7,70 €</b>
<b>1006179</b>	Couteau de table monobloc cranté	x 12	<b>6,40 €</b>
<b>1006180</b>	Cuillère à café	x 12	<b>4,60 €</b>
<b>1006181</b>	Cuillère à dessert	x 12	<b>5,70 €</b>
<b>1006182</b>	Fourchette à dessert	x 12	<b>5,70 €</b>
<b>1006183</b>	Couteau à dessert monobloc cranté	x 12	<b>6,10 €</b>
<b>1006184</b>	Fourchette à poisson	x 12	<b>6,10 €</b>
<b>1006185</b>	Couteau à poisson	x 12	<b>6,10 €</b>



# COUZON



## La création comme une évidence

COUZON a développé un savoir-faire Français qui s'exprime dans la création de collections de couverts et d'objets de table en acier de haute qualité.

Des gammes remarquables au design exclusif et contemporain.

Collection Neuvième art développée en partenariat avec Christophe Roure chef étoilé du Neuvième art.

## Alkaline

Épaisseur 4 mm. Finition poli-miroir.

COUZON 



		P.U. HT
<b>1010272P</b>	Cuillère de table	x 12 <b>4,60 €</b>
<b>1010273P</b>	Fourchette de table	x 12 <b>4,60 €</b>
<b>1010274P</b>	Couteau de table monobloc cranté	x 12 <b>6,30 €</b>
<b>1010278P</b>	Cuillère à café	x 12 <b>3,00 €</b>
<b>1010275</b>	Cuillère à dessert	x 12 <b>4,40 €</b>
<b>1010276</b>	Fourchette à dessert	x 12 <b>4,40 €</b>
<b>1010277</b>	Couteau à dessert monobloc cranté	x 12 <b>6,00 €</b>

## Neuvième Art

Épaisseur 4 mm. Finition poli-miroir.

COUZON 



		P.U. HT
<b>68439P</b>	Cuillère de table	x 12 <b>5,70 €</b>
<b>68440P</b>	Fourchette de table	x 12 <b>5,70 €</b>
<b>68441P</b>	Couteau de table monobloc cranté	x 12 <b>7,40 €</b>
<b>68442P</b>	Cuillère à café	x 12 <b>4,00 €</b>
<b>68443P</b>	Cuillère à dessert	x 12 <b>5,00 €</b>
<b>68444</b>	Fourchette à dessert	x 12 <b>5,00 €</b>
<b>68445</b>	Couteau à dessert monobloc cranté	x 12 <b>7,00 €</b>
<b>68446</b>	Fourchette à poisson	x 12 <b>5,90 €</b>
<b>68447</b>	Couteau à poisson	x 12 <b>5,90 €</b>
<b>68448P</b>	Cuillère à moka	x 12 <b>3,90 €</b>







## Pixelle 3D

Épaisseur 2,5 mm. Finition poli-mirair.

COUZON **INOX 18/10**







		Quantité	P.U. HT
	<b>1000561P</b>	Cuillère de table	x 12 <b>3,70 €</b>
	<b>1000562P</b>	Fourchette de table	x 12 <b>3,70 €</b>
	<b>1000567P</b>	Couteau de table monobloc cranté	x 12 <b>6,40 €</b>
	<b>1000566P</b>	Cuillère à café	x 12 <b>2,80 €</b>
	<b>1000563P</b>	Cuillère à dessert	x 12 <b>3,70 €</b>
	<b>1000564P</b>	Fourchette à dessert	x 12 <b>3,70 €</b>
	<b>1000565P</b>	Couteau à dessert monobloc cranté	x 12 <b>6,30 €</b>

## Millenium

Épaisseur 3,5 mm. Finition satinée.

COUZON **INOX 18/10**



		Quantité	P.U. HT
	<b>1011405P</b>	Cuillère de table	x 12 <b>3,70 €</b>
	<b>1011410P</b>	Fourchette de table	x 12 <b>3,70 €</b>
	<b>1011406P</b>	Couteau de table monobloc cranté	x 12 <b>4,70 €</b>
	<b>1011407P</b>	Cuillère à café	x 12 <b>2,20 €</b>
	<b>1011411P</b>	Cuillère à dessert	x 12 <b>3,20 €</b>
	<b>1011409P</b>	Fourchette à dessert	x 12 <b>3,20 €</b>
	<b>1011408P</b>	Couteau à dessert monobloc cranté	x 12 <b>4,50 €</b>



## Ezzo

Forgé. Finition poli-miroir.



INOX  
18/10



			P.U. HT
<b>57292P</b>	Cuillère de table	x 12	<b>3,90 €</b>
<b>57293P</b>	Fourchette de table	x 12	<b>3,90 €</b>
<b>57295P</b>	Couteau de table monobloc cranté	x 12	<b>4,40 €</b>
<b>57294</b>	Couteau de table monocoque cranté	x 36	<b>9,80 €</b>
<b>57300P</b>	Cuillère à café	x 12	<b>1,80 €</b>
<b>57296P</b>	Cuillère à dessert	x 12	<b>3,60 €</b>
<b>57297P</b>	Fourchette à dessert	x 12	<b>3,60 €</b>
<b>57299P</b>	Couteau à dessert monobloc cranté	x 12	<b>4,10 €</b>
<b>57302</b>	Fourchette à poisson	x 36	<b>3,60 €</b>
<b>57303</b>	Couteau à poisson	x 36	<b>3,60 €</b>
<b>57301P</b>	Cuillère à moka	x 12	<b>1,70 €</b>

## Lazzo

Forgé. Finition poli-miroir.



INOX  
18/10



			P.U. HT
<b>57341P</b>	Cuillère de table	x 12	<b>4,10 €</b>
<b>57342P</b>	Fourchette de table	x 12	<b>4,10 €</b>
<b>57344P</b>	Couteau de table monobloc cranté	x 12	<b>4,40 €</b>
<b>57349P</b>	Cuillère à café	x 12	<b>2,00 €</b>
<b>57345</b>	Cuillère à dessert	x 36	<b>3,20 €</b>
<b>57346</b>	Fourchette à dessert	x 36	<b>3,20 €</b>
<b>57348</b>	Couteau à dessert monobloc cranté	x 36	<b>3,90 €</b>
<b>57350P</b>	Cuillère à moka	x 12	<b>1,50 €</b>



## Zen

Forgé. Finition poli-miroir.

WNK®  
FIRST IN FOOD SERVICE

INOX  
18/10



Le couteau se pose  
sur son tranchant



			P.U. HT
<b>64747P</b>	Cuillère de table	x 12	<b>6,90 €</b>
<b>64746P</b>	Fourchette de table	x 12	<b>6,90 €</b>
<b>64745P</b>	Couteau de table monobloc cranté	x 12	<b>7,70 €</b>
<b>64754P</b>	Cuillère à café	x 12	<b>3,50 €</b>
<b>64750P</b>	Cuillère à dessert	x 12	<b>6,20 €</b>
<b>64749P</b>	Fourchette à dessert	x 12	<b>6,20 €</b>
<b>64748P</b>	Couteau à dessert monobloc cranté	x 12	<b>6,40 €</b>
<b>64753P</b>	Fourchette à poisson	x 12	<b>6,20 €</b>
<b>64752P</b>	Couteau à poisson	x 12	<b>6,80 €</b>
<b>64751P</b>	Cuillère à moka	x 12	<b>3,20 €</b>

## Spoon

Epaisseur 5 mm. Finition poli miroir.

WNK®  
FIRST IN FOOD SERVICE

INOX  
18/10



Fourchette  
3 dents



			P.U. HT
<b>64781P</b>	Cuillère de table	x 12	<b>4,00 €</b>
<b>64779P</b>	Fourchette de table	x 12	<b>4,00 €</b>
<b>64778P</b>	Couteau de table monobloc cranté	x 12	<b>4,20 €</b>
<b>64788P</b>	Cuillère à café	x 12	<b>2,40 €</b>
<b>64784P</b>	Cuillère à dessert	x 12	<b>3,70 €</b>
<b>64783P</b>	Fourchette à dessert	x 12	<b>3,70 €</b>
<b>64782P</b>	Couteau à dessert monobloc cranté	x 12	<b>4,20 €</b>
<b>64787P</b>	Fourchette à poisson	x 12	<b>3,50 €</b>
<b>64786P</b>	Couteau à poisson	x 12	<b>3,30 €</b>
<b>64785P</b>	Cuillère à moka	x 12	<b>2,40 €</b>



## Blois

Épaisseur 3,5 mm. Finition poli-miroir.

DEGRENE  
PARIS

INOX  
18/10



Votre touche personnelle fait la différence :  
consultez-nous pour personnaliser vos couverts.  
Une façon originale de se distinguer



			P.U. HT
<b>52709</b>	Cuillère de table	x 12	<b>5,70 €</b>
<b>52710P</b>	Fourchette de table	x 12	<b>5,70 €</b>
<b>52711P</b>	Couteau de table monocoque cranté	x 12	<b>11,70 €</b>
<b>52717P</b>	Cuillère à café	x 12	<b>2,70 €</b>
<b>52712P</b>	Cuillère à dessert	x 12	<b>4,40 €</b>
<b>52713P</b>	Fourchette à dessert	x 12	<b>4,40 €</b>
<b>52714P</b>	Couteau à dessert monocoque cranté	x 12	<b>11,80 €</b>
<b>52718P</b>	Cuillère à moka	x 12	<b>2,50 €</b>

**nouveau !**

## Guest Vintage

Épaisseur 4 mm. Finition étain.

DEGRENE  
PARIS

INOX  
18/10



Patine grisée pour un  
esprit vintage



			P.U. HT
<b>1013119</b>	Cuillère de table	x 12	<b>6,00 €</b>
<b>1013118</b>	Fourchette de table	x 12	<b>6,00 €</b>
<b>1013122</b>	Couteau de table monobloc cranté	x 12	<b>8,60 €</b>
<b>1013123</b>	Cuillère à café	x 12	<b>3,90 €</b>
<b>1013120</b>	Cuillère à dessert	x 12	<b>5,80 €</b>
<b>1013121</b>	Fourchette à dessert	x 12	<b>5,80 €</b>
<b>1013124</b>	Couteau à dessert monobloc cranté	x 12	<b>8,00 €</b>



## Alinéa

Épaisseur 4 mm. Finition poli-miroir.

eternum produit 1924 INOX 18/10



			P.U.HT
🛒 58223	Cuillère de table	x 12	3,80 €
🛒 58224	Fourchette de table	x 12	3,80 €
🛒 58225	Couteau de table monobloc cranté	x 12	5,10 €
🛒 58228	Couteau à steak monobloc cranté	x 12	5,00 €
🛒 58232	Cuillère à café	x 12	2,10 €
58236	Cuillère à dessert	x 12	4,10 €
58226	Fourchette à dessert	x 12	3,50 €
58227	Couteau à dessert monobloc cranté	x 12	4,80 €
58229	Fourchette à poisson	x 12	4,80 €
58230	Couteau à poisson	x 12	3,50 €
58231	Cuillère à moka	x 12	2,10 €
58233	Cuillère à consommé	x 12	4,50 €
58234	Fourchette à gâteau	x 12	2,50 €
58235	Couteau à fruit	x 12	4,10 €

## Galaxy

Épaisseur 3 mm. Finition poli-miroir.

eternum produit 1924 INOX 18/10



			P.U.HT
1005675	Cuillère de table	x 12	3,00 €
1005676	Fourchette de table	x 12	3,00 €
1005677	Couteau de table monobloc cranté	x 12	3,30 €
1005678	Cuillère à café	x 12	1,50 €
1005679	Cuillère à dessert	x 12	2,50 €
1005680	Fourchette à dessert	x 12	2,50 €
1005681	Couteau à dessert monobloc cranté	x 12	3,10 €





## Aruba

Forgé. Finition poli miroir.



			<b>P.U. HT</b>
<b>57046P</b>	Cuillère de table	x 12	<b>4,80 €</b>
<b>57047P</b>	Fourchette de table	x 12	<b>4,80 €</b>
<b>57048P</b>	Couteau de table monobloc cranté	x 12	<b>4,90 €</b>
<b>57049P</b>	Cuillère à café	x 12	<b>4,10 €</b>
<b>58661P</b>	Cuillère à dessert	x 12	<b>4,70 €</b>
<b>58662P</b>	Fourchette à dessert	x 12	<b>4,70 €</b>
<b>58663P</b>	Couteau à dessert monobloc cranté	x 12	<b>4,70 €</b>
<b>58665P</b>	Fourchette à poisson	x 12	<b>5,00 €</b>
<b>58664P</b>	Couteau à poisson	x 12	<b>5,00 €</b>
<b>58666P</b>	Cuillère à moka	x 12	<b>4,00 €</b>

## Alaska

Epaisseur 3,5 mm. Finition poli-miroir.



			<b>P.U. HT</b>
<b>48554P</b>	Cuillère de table	x 12	<b>3,30 €</b>
<b>48557P</b>	Fourchette de table	x 12	<b>3,30 €</b>
<b>48547P</b>	Couteau de table monobloc cranté	x 12	<b>4,70 €</b>
<b>48550P</b>	Couteau à steak monobloc cranté	x 12	<b>5,00 €</b>
<b>48551P</b>	Cuillère à café	x 12	<b>1,80 €</b>
<b>48552P</b>	Cuillère à dessert	x 12	<b>2,90 €</b>
<b>48555P</b>	Fourchette à dessert	x 12	<b>2,90 €</b>
<b>48548P</b>	Couteau à dessert monobloc cranté	x 12	<b>3,60 €</b>
<b>48556</b>	Fourchette à poisson	x 12	<b>2,50 €</b>
<b>48549</b>	Couteau à poisson	x 12	<b>2,50 €</b>
<b>48553P</b>	Cuillère à moka	x 12	<b>1,50 €</b>



## Wave Ciselé

Épaisseur 3,5 mm. Finition poli miroir.



			P.U.HT
<b>1002384P</b>	Cuillère de table	x 12	<b>3,50 €</b>
<b>1002385P</b>	Fourchette de table	x 12	<b>3,50 €</b>
<b>1002386P</b>	Couteau de table monobloc cranté	x 12	<b>4,70 €</b>
<b>1002388P</b>	Couteau à steak monobloc cranté	x 12	<b>4,40 €</b>
<b>1002387P</b>	Cuillère à café	x 12	<b>1,80 €</b>
<b>1002389P</b>	Cuillère à dessert	x 12	<b>2,90 €</b>
<b>1002390P</b>	Fourchette à dessert	x 12	<b>2,90 €</b>
<b>1002391P</b>	Couteau à dessert monobloc cranté	x 12	<b>3,80 €</b>
<b>1007014P</b>	Cuillère à moka	x 12	<b>1,60 €</b>



x 12  
x 12  
x 12  
x 12  
x 12  
x 12  
x 12  
x 12  
x 12

**3,50 €**  
**3,50 €**  
**4,70 €**  
**4,40 €**  
**1,80 €**  
**2,90 €**  
**2,90 €**  
**3,80 €**  
**1,60 €**

## Wave

Épaisseur 3,5 mm. Finition poli-miroir.



			P.U.HT
<b>69525P</b>	Cuillère de table	x 12	<b>3,20 €</b>
<b>69524P</b>	Fourchette de table	x 12	<b>3,20 €</b>
<b>69526P</b>	Couteau de table monobloc cranté	x 12	<b>4,10 €</b>
<b>1000396P</b>	Couteau à steak monobloc cranté	x 12	<b>4,60 €</b>
<b>69532P</b>	Cuillère à café	x 12	<b>1,70 €</b>
<b>69528P</b>	Cuillère à dessert	x 12	<b>2,80 €</b>
<b>69527P</b>	Fourchette à dessert	x 12	<b>2,80 €</b>
<b>69529P</b>	Couteau à dessert monobloc cranté	x 12	<b>3,60 €</b>
<b>69530P</b>	Fourchette à poisson	x 12	<b>3,30 €</b>
<b>69531P</b>	Couteau à poisson	x 12	<b>3,30 €</b>
<b>69533P</b>	Cuillère à moka	x 12	<b>1,40 €</b>



x 12  
x 12  
x 12  
x 12  
x 12  
x 12  
x 12  
x 12  
x 12  
x 12

**3,20 €**  
**3,20 €**  
**4,10 €**  
**4,60 €**  
**1,70 €**  
**2,80 €**  
**2,80 €**  
**3,60 €**  
**3,30 €**  
**3,30 €**  
**1,40 €**



## Orenok

Épaisseur 2,5 mm. Finition poli miroir.



INOX  
18/10



			P. U. HT
<b>65516P</b>	Cuillère de table	x 12	<b>2,80 €</b>
<b>65517P</b>	Fourchette de table	x 12	<b>2,80 €</b>
<b>65518P</b>	Couteau de table monobloc cranté	x 12	<b>2,90 €</b>
<b>65520P</b>	Cuillère à café	x 12	<b>1,60 €</b>
<b>65519P</b>	Cuillère à dessert	x 12	<b>2,70 €</b>
<b>65521P</b>	Fourchette à dessert	x 12	<b>2,70 €</b>
<b>65522P</b>	Couteau à dessert monobloc cranté	x 12	<b>2,80 €</b>
<b>65525P</b>	Cuillère à moka	x 12	<b>1,50 €</b>

## Izia

Épaisseur 3 mm. Finition poli miroir.



INOX  
18/10



			P. U. HT
<b>1011369P</b>	E Cuillère de table	x 12	<b>2,60 €</b>
<b>1012070P</b>	E Fourchette de table	x 12	<b>2,60 €</b>
<b>1011371P</b>	E Couteau de table monobloc cranté	x 12	<b>3,50 €</b>
<b>1011370P</b>	E Cuillère à café	x 12	<b>1,50 €</b>
<b>1011372P</b>	E Cuillère à dessert	x 12	<b>2,50 €</b>
<b>1011373P</b>	E Fourchette à dessert	x 12	<b>2,50 €</b>
<b>1011374P</b>	E Couteau à dessert monobloc cranté	x 12	<b>3,10 €</b>



# Héritage

COUZON



En inox argenté. Epaisseur 3,5 mm.

			P.U.HT
<b>70291P</b>	Cuillère de table	x 12	17,25 €
<b>70292P</b>	Fourchette de table	x 12	17,25 €
<b>70293P</b>	Couteau de table monocoque cranté	x 12	20,75 €
<b>70294P</b>	Cuillère à café	x 12	9,10 €
<b>70295P</b>	Cuillère à dessert	x 12	15,00 €
<b>70296P</b>	Fourchette à dessert	x 12	15,00 €
<b>70297P</b>	Couteau à dessert monocoque cranté	x 12	19,25 €
<b>70299P</b>	Fourchette à poisson	x 12	15,75 €
<b>70300P</b>	Couteau à poisson	x 12	15,50 €
<b>70298P</b>	Cuillère à moka	x 12	7,60 €

Epaisseur 3,5 mm. Finition poli-miroir.

INOX 18/10

			P.U.HT
<b>69514P</b>	Cuillère de table	x 12	4,50 €
<b>69515P</b>	Fourchette de table	x 12	4,50 €
<b>69516P</b>	Couteau de table monocoque cranté	x 12	8,30 €
<b>69517P</b>	Cuillère à café	x 12	2,50 €
<b>69519P</b>	Cuillère à dessert	x 12	3,90 €
<b>69518P</b>	Fourchette à dessert	x 12	3,90 €
<b>69520P</b>	Couteau à dessert monocoque cranté	x 12	8,10 €
<b>69521P</b>	Fourchette à poisson	x 12	4,30 €
<b>69522P</b>	Couteau à poisson	x 12	4,30 €
<b>69523P</b>	Cuillère à moka	x 12	1,90 €

# Settecento

Epaisseur 3 mm. Finition stoned washed.

PINTINOX INOX 18/10 MADE IN ITALY



			P.U.HT
<b>1007151P</b>	Cuillère de table	x 12	4,20 €
<b>1007152P</b>	Fourchette de table	x 12	4,20 €
<b>1007153P</b>	Couteau de table monobloc cranté	x 12	6,80 €
<b>1007154P</b>	Cuillère à café	x 12	2,50 €
<b>1008711</b>	Cuillère à dessert	x 12	3,40 €
<b>1008709</b>	Fourchette à dessert	x 12	3,40 €
<b>1008710</b>	Couteau à dessert monobloc cranté	x 12	5,40 €
<b>1008712</b>	Cuillère à moka	x 12	2,10 €

# nouveau !

# Marquise

Epaisseur 3,5 mm. Finition poli-miroir.

DEGRENNE INOX 18/10



			P.U.HT
<b>1013111</b>	Cuillère de table	x 12	6,50 €
<b>1013112</b>	Fourchette de table	x 12	6,50 €
<b>1013113</b>	Couteau de table monocoque cranté	x 12	13,50 €
<b>1013117</b>	Cuillère à café	x 12	3,90 €
<b>1013114</b>	Cuillère à dessert	x 12	6,10 €
<b>1013115</b>	Fourchette à dessert	x 12	6,10 €
<b>1013116</b>	Couteau à dessert monocoque cranté	x 12	12,90 €



## Arcade

Épaisseur 3,5 mm. Finition poli-miroir.

eternum INOX 18/10

			P.U. HT
✓ 48610P	Cuillère de table	x 12	3,10 €
✓ 48611P	Fourchette de table	x 12	3,10 €
✓ 48613P	Couteau de table monobloc cranté	x 12	4,00 €
48612	Couteau de table monocoque cranté	x 12	8,30 €
48614P	Couteau à steak monobloc cranté	x 12	4,70 €
✓ 48619P	Cuillère à café	x 12	1,60 €
✓ 48616P	Cuillère à dessert	x 12	3,00 €
✓ 48615P	Fourchette à dessert	x 12	3,00 €
✓ 48618P	Couteau à dessert monobloc cranté	x 12	4,00 €
48622P	Fourchette à poisson	x 12	3,00 €
✓ 48621P	Couteau à poisson	x 12	4,00 €
✓ 48620P	Cuillère à moka	x 12	1,60 €



## Anser

Épaisseur 3 mm. Finition poli-miroir.

eternum INOX 18/10

Disponible en métal argenté, nous consulter



			P.U. HT
✓ 49191	E Cuillère de table	x 12	2,60 €
✓ 49192	E Fourchette de table	x 12	2,60 €
✓ 49133	E Couteau de table monobloc cranté	x 12	3,50 €
49132	E Couteau de table monocoque cranté	x 12	9,30 €
✓ 49140	E Cuillère à café	x 12	1,40 €
✓ 49134	Cuillère à dessert	x 12	2,50 €
✓ 49135	Fourchette à dessert	x 12	2,50 €
49137	Couteau à dessert monobloc cranté	x 12	3,30 €
49136	Couteau à dessert monocoque cranté	x 12	9,20 €
49138	Fourchette à poisson	x 12	2,50 €
49139	Couteau à poisson	x 12	2,50 €
✓ 49141	Cuillère à moka	x 12	1,40 €
43362	Fourchette à gâteau	x 12	2,00 €
49142	Fourchette à huître	x 12	2,10 €
36309	Louche	x 1	32,50 €
49143	Fourchette à escargot	x 12	5,20 €
43363	Cuillère à dégustation	x 1	8,00 €
36310	Pelle à tarte	x 1	27,75 €





## Vieux Paris PM

Epaisseur 3 mm. Finition poli-miroir.



			<b>P.U.HT</b>
<b>64490P</b>	Cuillère de table	x 12	<b>3,10 €</b>
<b>64491P</b>	Fourchette de table	x 12	<b>3,10 €</b>
<b>64500P</b>	Couteau de table monobloc cranté	x 12	<b>3,70 €</b>
<b>64492P</b>	Couteau de table monocoque cranté	x 12	<b>7,30 €</b>
<b>65503P</b>	Couteau à steak monobloc cranté	x 12	<b>3,60 €</b>
<b>64498P</b>	Cuillère à café	x 12	<b>2,20 €</b>
<b>64493P</b>	Cuillère à dessert	x 12	<b>3,00 €</b>
<b>64494P</b>	Fourchette à dessert	x 12	<b>3,00 €</b>
<b>64501P</b>	Couteau à dessert monobloc cranté	x 12	<b>3,40 €</b>
<b>64495P</b>	Couteau à dessert monocoque cranté	x 12	<b>6,90 €</b>
<b>64496P</b>	Fourchette à poisson	x 12	<b>3,00 €</b>
<b>64497P</b>	Couteau à poisson	x 12	<b>3,00 €</b>
<b>64499P</b>	Cuillère à moka	x 12	<b>2,00 €</b>

## Baguette PM

Epaisseur 3 mm. Finition poli-miroir.



			<b>P.U.HT</b>
<b>65505P</b>	Cuillère de table	x 12	<b>3,10 €</b>
<b>65506P</b>	Fourchette de table	x 12	<b>3,10 €</b>
<b>65507P</b>	Couteau de table monobloc cranté	x 12	<b>3,70 €</b>
<b>1005734P</b>	Couteau de table monocoque cranté	x 12	<b>7,30 €</b>
<b>65515P</b>	Couteau à steak monobloc cranté	x 12	<b>3,80 €</b>
<b>65508P</b>	Cuillère à café	x 12	<b>2,10 €</b>
<b>65510P</b>	Cuillère à dessert	x 12	<b>3,00 €</b>
<b>65511P</b>	Fourchette à dessert	x 12	<b>3,00 €</b>
<b>65512P</b>	Couteau à dessert monobloc cranté	x 12	<b>3,70 €</b>
<b>1005735P</b>	Couteau à dessert monocoque cranté	x 12	<b>6,90 €</b>
<b>65513P</b>	Fourchette à poisson	x 12	<b>3,00 €</b>
<b>65514P</b>	Couteau à poisson	x 12	<b>2,90 €</b>
<b>65509P</b>	Cuillère à moka	x 12	<b>1,60 €</b>



## Carlton

En inox 18/0. Forgé. Finition poli-miroir.



<b>1012068P</b>	Cuillère de table	x 12	<b>1,60 €</b>
<b>1012069P</b>	Fourchette de table	x 12	<b>1,60 €</b>
<b>1012066P</b>	Couteau de table monobloc cranté	x 12	<b>2,00 €</b>
<b>1012065P</b>	Couteau à steak monobloc cranté	x 12	<b>2,00 €</b>
<b>1012067P</b>	Cuillère à café	x 12	<b>1,10 €</b>



**P.U. HT**

x 12 **1,60 €**  
 x 12 **1,60 €**  
 x 12 **2,00 €**  
 x 12 **2,00 €**  
 x 12 **1,10 €**



## Arobase

En inox 18/0. Epaisseur 3 mm. Finition poli-miroir.



<b>62059P</b>	Cuillère de table	x 12	<b>1,70 €</b>
<b>62060P</b>	Fourchette de table	x 12	<b>1,70 €</b>
<b>62061P</b>	Couteau de table monobloc cranté	x 12	<b>2,50 €</b>
<b>62062P</b>	Cuillère à café	x 12	<b>0,92 €</b>
<b>62063P</b>	Cuillère à dessert	x 12	<b>1,60 €</b>
<b>62066P</b>	Cuillère à moka	x 12	<b>0,65 €</b>



**P.U. HT**

x 12 **1,70 €**  
 x 12 **1,70 €**  
 x 12 **2,50 €**  
 x 12 **0,92 €**  
 x 12 **1,60 €**  
 x 12 **0,65 €**



## Style 180

En inox 18/0. Epaisseur 3 mm. Finition poli-miroir.



			P.U.HT
☞	<b>58527P</b>	E Cuillère de table	x 12 <b>1,50 €</b>
☞	<b>58528P</b>	E Fourchette de table	x 12 <b>1,50 €</b>
☞	<b>58529P</b>	E Couteau de table monobloc cranté	x 12 <b>2,20 €</b>
☞	<b>58530P</b>	E Cuillère à café	x 12 <b>0,91 €</b>
	<b>58531P</b>	E Cuillère à dessert	x 12 <b>1,50 €</b>
	<b>58532P</b>	E Fourchette à dessert	x 12 <b>1,50 €</b>
	<b>58533P</b>	E Couteau à dessert monobloc cranté	x 12 <b>2,40 €</b>
	<b>59080P</b>	E Cuillère à moka	x 12 <b>0,68 €</b>

nouveau !

## Trilogy

En inox 18/0. Epaisseur 2 mm. Finition poli-miroir. Une idée originale pour optimiser l'espace sur une table : un set de trois pièces emboîtables.

Emboîtables



			P.U.HT
	<b>1013298P</b>	Fourchette de table	x 12 <b>1,40 €</b>
	<b>1013297P</b>	Couteau de table	x 12 <b>2,50 €</b>
	<b>1013299</b>	Cuillère à dessert	x 12 <b>1,20 €</b>

## Aztek

En inox 18/0. Epaisseur 2,5 mm. Finition poli-miroir.



			P.U.HT
☞	<b>1002166P</b>	E Cuillère de table	x 12 <b>1,30 €</b>
☞	<b>1002167P</b>	E Fourchette de table	x 12 <b>1,30 €</b>
☞	<b>1002168P</b>	E Couteau de table monobloc cranté	x 12 <b>2,30 €</b>
☞	<b>1002169P</b>	E Cuillère à café	x 12 <b>0,83 €</b>
	<b>1002170P</b>	E Cuillère à dessert	x 12 <b>1,20 €</b>
	<b>1002171P</b>	E Fourchette à dessert	x 12 <b>1,20 €</b>
	<b>1002172P</b>	E Couteau à dessert monobloc cranté	x 12 <b>2,10 €</b>

## Adagio

En inox 18/0. Epaisseur 2,5 mm. Finition poli-miroir.



			P.U.HT
	<b>1006103P</b>	E Cuillère de table	x 12 <b>1,30 €</b>
	<b>1006104P</b>	E Fourchette de table	x 12 <b>1,30 €</b>
	<b>1006105P</b>	E Couteau de table monobloc cranté	x 12 <b>2,10 €</b>
	<b>1006106P</b>	E Cuillère à café	x 12 <b>0,72 €</b>
	<b>1007083P</b>	E Cuillère à dessert	x 12 <b>1,10 €</b>
	<b>1011657</b>	E Fourchette à dessert	x 12 <b>0,96 €</b>
	<b>1011656</b>	E Couteau à dessert monobloc cranté	x 12 <b>1,80 €</b>
	<b>1011658</b>	Palette sauce et poisson	x 12 <b>0,93 €</b>



## Ingres

En inox 18/0. Epaisseur 2,5 mm. Finition poli miroir.

eternum  
fonderie 1924



			P.U. HT
49109	Cuillère de table	x 12	2,20 €
49110P	Fourchette de table	x 12	2,20 €
49111P	Couteau de table monobloc cranté	x 12	3,10 €
49115	Cuillère à café	x 12	1,10 €
49112	Cuillère à dessert	x 12	2,00 €
49113	Fourchette à dessert	x 12	2,00 €
49114	Couteau à dessert monobloc cranté	x 12	3,50 €
49117	Fourchette à poisson	x 12	2,20 €
49118	Couteau à poisson	x 12	2,40 €
49119	Fourchette à huitre	x 12	1,60 €
49120	Fourchette à escargot	x 12	1,60 €
49116	Cuillère à moka	x 12	1,10 €

## Ecobaguette

En inox 18/0. Epaisseur 2,5 mm. Finition poli miroir.

eternum  
fonderie 1924



			P.U. HT
65718P	E Cuillère de table	x 12	1,20 €
65711P	E Fourchette de table	x 12	1,20 €
53345P	E Couteau de table monobloc cranté	x 12	2,60 €
65715P	E Cuillère à café	x 12	0,79 €
65713P	E Cuillère à dessert	x 12	1,10 €
65712P	E Fourchette à dessert	x 12	1,20 €
53351P	E Couteau à dessert monobloc cranté	x 12	2,90 €
65714P	E Cuillère à moka	x 12	0,65 €

## Fjord

En inox 18/0. Epaisseur 2,5 mm. Finition poli-miroir.

eternum  
fonderie 1924



			P.U. HT
62730	Cuillère de table	x 12	1,40 €
62729	Fourchette de table	x 12	1,40 €
62732	Couteau de table monobloc cranté	x 12	2,30 €
62731	Cuillère à café	x 12	0,74 €
63668	Cuillère à dessert	x 12	1,20 €
63661	Fourchette à dessert	x 12	1,20 €
63670	Couteau à dessert monobloc cranté	x 12	2,20 €
63663	Cuillère à moka	x 12	0,28 €

## Frida

En inox 18/0. Epaisseur 2,2 mm. Finition poli-brillant.

eternum  
fonderie 1924



			P.U. HT
49082P	E Cuillère de table	x 12	0,94 €
49083P	E Fourchette de table	x 12	0,94 €
49084P	E Couteau de table monobloc cranté	x 12	1,80 €
49088P	E Cuillère à café	x 12	0,59 €
49085P	E Cuillère à dessert	x 12	0,90 €
49086P	E Fourchette à dessert	x 12	0,90 €
49087P	E Couteau à dessert monobloc cranté	x 12	1,70 €
49193	E Fourchette à poisson	x 12	1,10 €
49194	E Couteau à poisson	x 12	1,10 €
49091	Fourchette à escargot	x 12	1,10 €
49090P	Fourchette à huitre	x 12	0,88 €
49092P	Cuillère à mélange	x 12	0,53 €
49089P	E Cuillère à moka	x 12	0,62 €



## Octave

En inox 18/0. Epaisseur 2 mm. Finition poli-miroir.



<b>68047P</b>	E Cuillère de table	x 12	<b>2,00 €</b>
<b>68048P</b>	E Fourchette de table	x 12	<b>2,00 €</b>
<b>68049P</b>	E Couteau de table monobloc cranté	x 12	<b>3,10 €</b>
<b>68050P</b>	E Cuillère à café	x 12	<b>1,20 €</b>

## Eco max

En inox 18/0. Epaisseur 2 mm. Finition poli standard.



<b>68043P</b>	E Cuillère de table	x 12	<b>0,80 €</b>
<b>68044P</b>	E Fourchette de table	x 12	<b>0,83 €</b>
<b>68045P</b>	E Couteau de table monobloc cranté	x 12	<b>1,10 €</b>
<b>68046P</b>	E Cuillère à café	x 12	<b>0,37 €</b>

## Vieux Paris

En inox 18/0. Epaisseur 2 mm. Finition poli standard.



<b>70471P</b>	E Cuillère de table	x 12	<b>0,85 €</b>
<b>70399P</b>	E Fourchette de table	x 12	<b>0,85 €</b>
<b>68054P</b>	E Couteau de table monobloc cranté	x 12	<b>2,00 €</b>
<b>70400P</b>	E Cuillère à café	x 12	<b>0,43 €</b>
<b>70401P</b>	E Cuillère à dessert	x 12	<b>0,85 €</b>
<b>70402P</b>	E Fourchette à dessert	x 12	<b>0,85 €</b>
<b>68058P</b>	E Couteau à dessert monobloc cranté	x 12	<b>1,90 €</b>

## Baltik

En inox 18/0. Epaisseur 1,5 mm. Finition poli standard.



<b>68208P</b>	Cuillère de table	x 12	<b>0,50 €</b>
<b>68209P</b>	Fourchette de table	x 12	<b>0,50 €</b>
<b>68210P</b>	Couteau de table monobloc cranté	x 12	<b>1,50 €</b>
<b>68211P</b>	Cuillère à café	x 12	<b>0,33 €</b>

## Amande

Inox 18/0. Epaisseur 2 mm. Finition poli brillant.  
Manche couleur en ABS.



	Jaune	Orange	Rouge	Bleu marine	Vert	Blanc	P.U.HT
Cuillère de table	1002451	1002431	1002435P	1002439P	E 1002443P	1002447	x 12 1,10 €
Fourchette de table	1002450	1002430	1002434P	1002438P	E 1002442P	1002446	x 12 1,10 €
Couteau de table cranté	1002449	1002429	1002433P	1002437P	E 1002441P	1002445	x 12 1,10 €
Cuillère à café	1002452P	1002432P	1002436P	1002440P	E 1002444P	1002448P	x 12 0,93 €

## Eco

Inox 18/0. Epaisseur 1,5 mm. Finition poli standard.



	P.U.HT
68035P E Cuillère de table	x 12 0,30 €
68034P E Fourchette de table	x 12 0,30 €
68036P E Couteau de table monobloc cranté	x 12 0,62 €
6554P E Cuillère à café	x 48 0,15 €
68038P E Cuillère à dessert	x 12 0,48 €
68039P E Fourchette à dessert	x 12 0,48 €
68040P E Couteau à dessert monobloc cranté	x 12 0,91 €
68456P E Pelle à tarte	x 1 1,80 €
68042P E Fourchette à huîtres	x 12 0,45 €
68454P E Fourchette à escargot	x 12 0,51 €
68453P E Fourchette de service	x 1 2,20 €
68452P E Cuillère de service	x 1 2,20 €
68455P E Louche	x 1 2,50 €
68041P E Cuillère à soda	x 12 0,52 €
5560P E Cuillère à moka	x 12 0,19 €

## Couvert Handicap

Couvert ergonomiques en polypropylène. Réglable en 3 positions pour obtenir la forme la plus adaptée. Embout souple qui ne blesse pas la bouche.



Cuillère	P.U.HT
Gris/vert anis 68566 E x 1	18,75 €
Gris/framboise 68568 E x 1	18,75 €
Gris/orange 68567 E x 1	18,75 €

Fourchette	P.U.HT
Gris/vert anis 68569 E x 1	18,25 €
Gris/framboise 68571 E x 1	18,25 €
Gris/orange 68570 E x 1	18,25 €

## Couvert ergonomique

En copolyester.



Couteau L. 21 cm	P.U.HT
Bleu 1005302 E x 12	1,60 €
Vert 1005304 E x 12	1,60 €
Orange 1005305 E x 12	1,60 €

Cuillère L. 21 cm	P.U.HT
Bleu 1007076 E x 12	1,80 €
Vert 1007077 E x 12	1,80 €
Orange 1007078 E x 12	1,80 €

Fourchette L. 21 cm	P.U.HT
Bleu 1007079 E x 12	1,80 €
Vert 1007080 E x 12	1,80 €
Orange 1007081 E x 12	1,80 €

## Couvert Handicap

Manche en ABS noir. Finition poli miroir. Epaisseur 3 mm.



	P.U.HT
64237 E Fourchette de table	x 12 5,50 €
64239 E Cuillère de table	x 12 5,50 €
64241 E Couteau droit monobloc cranté	x 12 5,50 €
64243 E Fourchette de table courbe pour droitier	x 12 6,10 €
64245 E Cuillère de table courbe pour droitier	x 12 6,10 €
64249 E Fourchette de table courbe pour gaucher	x 12 6,10 €
64251 E Cuillère de table courbe pour gaucher	x 12 6,10 €
64247 E Couteau incliné monobloc cranté	x 12 6,10 €



Premium

9.47

Lame inox unie de 10,7 cm. Pleine soie. Manche polyacétal.



**60337P** x 6 P.U.HT 46,75 €

Royal

Manche PAN. Lame inox crantée de 10 cm, avec 3 rivets blancs.



**1007150P** x 12 P.U.HT 7,20 €

Expression

Lame inox unie de 11 cm. Pleine soie. Manche POM.



**71163P** x 12 P.U.HT 11,80 €

Expression Côte à l'os

Lame inox unie de 12 cm. Pleine soie. Manche ABS.



**1005486P** x 12 P.U.HT 11,90 €

Brasserie

Lame inox crantée de 12 cm. Pleine soie. Manche POM.



**1011146** x 12 P.U.HT 6,00 €

X ray

Lame inox crantée de 12 cm. Manche en polypropylène.



**10044P** x 12 P.U.HT 7,80 €

Evolution

Lame inox micro-dentée de 11 cm. Manche plat en ABS.



**36328P** E x 12 P.U.HT 2,80 €

Jumbo

Lame inox crantée de 11,8 cm. Manche ergonomique en ABS.



**1011619P** x 12 P.U.HT 2,60 €

nouveau !

773

Lame inox de 12,2 cm. Manche en ABS noir, 3 rivets inox.



**1014088** x 12 P.U.HT 9,90 €

Fusion

Lame acier Mov de 10,8 cm. Manche ABS noir mat, 2 rivets inox.



**1013295P** x 12 P.U.HT 7,90 €



Premium

### Héritage

Tout inox. Lame de 9 cm. Monobloc micro-denté.



71164P



x 12

P.U.HT  
8,10 €

### Alinéa

Tout inox. Monobloc cranté.



58228



x 12

P.U.HT  
5,00 €

### Profile

Tout inox. Lame de 12,3 cm. Monobloc cranté. Manche ergonomique.



68063P



x 12

P.U.HT  
5,30 €

### Alaska

Tout inox. Monobloc cranté.



48550P



x 12

P.U.HT  
5,00 €

### Arcade

Tout inox. Monobloc cranté.



48614P



x 12

P.U.HT  
4,70 €

### Goliath

Tout inox. Lame de 12 cm. Monobloc cranté.



1011768P



x 12

P.U.HT  
3,60 €

### Vieux Paris PM

Tout inox. Monobloc cranté.



65503P



x 12

P.U.HT  
3,60 €

### Wave

Tout inox. Lame de 11 cm. Monobloc cranté.



1000396P



x 12

P.U.HT  
4,60 €

### Laguiole

Tout inox. Lame de 11 cm crantée. Pleine soie.



Boîte de 24  
58340P



x 1

P.U.HT  
76,50 €

### Baguette PM

Tout inox. Lame de 11 cm. Monobloc cranté.



65515P



x 12

P.U.HT  
3,80 €

### Shark

Tout inox. Lame de 7,5 cm. Monobloc cranté.



65225P



x 12

P.U.HT  
2,60 €

nouveau !

### Carlton

Tout inox. Finition poli-miroir. Forgé.



1012065P



x 12

P.U.HT  
2,00 €

COUTEAUX À STEAK



ART DE LA TABLE

*Premium*

### Gran chaco

Manche en bois. 3 rivets en laiton.  
Lame inox unie de 12,5 cm pour un tranchant net.



**68060P** x 12 **P.U.HT**  
**10,00 €**

### Bois compressé



Manche en bois compressé verni. 2 rivets. Lame inox crantée de 11 cm.



Boîte de 12 **P.U.HT**  
**53402P** x 1 **39,75 €**

**nouveau !**

### Côte de bœuf

Couteau manche bois. 3 rivets. Lame 12 cm crantée, bout rond.



**1012378P** x 12 **P.U.HT**  
**3,60 €**

**nouveau !**

### Pizza

Manche en bois de pakka. 2 rivets. Lame inox crantée de 10 cm.



**1013296P** x 12 **P.U.HT**  
**3,20 €**

### Lupo

Manche en bois de Stamina. 3 rivets en laiton.  
Lame inox micro-dentée pleine soie de 10 cm.



**68062P** x 6 **P.U.HT**  
**9,20 €**

### Steak / pizza

Couverts avec manche 2 rivets en ABS noir pour exprimer le caractère traditionnel de votre table.



**1001228P** Couteau à steak lame crantée de 10 cm x 12 **P.U.HT**  
**2,60 €**  
**1010269P** Fourchette x 12 **2,40 €**  
**1010270** Cuillère de table x 12 **2,40 €**

### Côte à l'os

Manche en bois compressé. Lame inox micro-dentée de 11 cm.



**53403** x 12 **P.U.HT**  
**6,70 €**

## LES BASIQUES

### 2 rivets

Manche en polypropylène surmoulé noir. Lame inox micro-dentée de 12 cm.  
Résistant au lave-vaisselle.



Boîte de 24 **P.U.HT**  
**48383P** E x 1 **21,00 €**

### Rivets blanc

Manche en polypropylène. 2 rivets blancs. Lame inox micro-dentée de 11 cm.



**68059P** x 12 **P.U.HT**  
**1,20 €**

### Surmoulé

Manche ABS surmoulé noir. Lame inox crantée de 10,5 cm.  
Résistant au lave-vaisselle.



Boîte de 24 **P.U.HT**  
**53093P** x 1 **23,25 €**

### Basic

Manche en ABS surmoulé noir. Lame inox micro-dentée de 11,5 cm. Résistant au lave-vaisselle.



Boîte de 24 **P.U.HT**  
**51034P** E x 1 **9,20 €**



## COUVERTS DE SPÉCIALITÉS

### Couteau à pizza

Lame inox bombée et pointue de 11 cm.  
Manche en polypropylène.



49375P x 12 P.U.HT 3,50 €

### Couteau à fromage

Lame inox. Manche en palissandre avec 3 rivets.



60538P L. lame 17 cm x 1 P.U.HT 20,25 €

### Cuillère fourchette Hédonie

INOX 18/10

Finition poli-miroir. Ep. 4 mm. L'arrondi doux et profond permet de savourer tous les plats en sauce, la partie dentelée permet de couper et saisir.



1004277P L. 18,7 cm x 12 P.U.HT 5,10 €

### Cuillère fourchette Hédonie

En inox 18/0. Finition poli standard. Ep. 1,2 mm. Permet de recueillir et de piquer conjointement.



1006003P L. 10,8 cm x 12 P.U.HT 0,79 €

### Cuillère Voluto

ARCOROC

En inox 18/0. Finition poli-miroir.

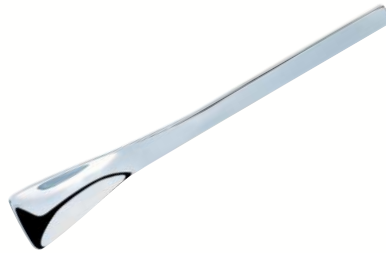

1002622P Glace - L. 20 cm x 12 P.U.HT 1,20 €  
1002624P Thé - L. 15,5 cm x 12 P.U.HT 0,83 €  
1002623P Café - L. 11,5 cm x 12 P.U.HT 0,64 €

### Cuillère Slalom

En inox 18/0. Finition poli-miroir. Sa forme permet de l'accrocher directement sur les bords de la coupe dessert.



68269P L. 16,5 cm x 12 P.U.HT 4,30 €

### Cuillère à glace

En inox 18/0. Finition poli-miroir.



1000158P L. 22,7 cm x 12 P.U.HT 3,00 €

## ACCESSOIRES COUVERTS

### Distributeur Discover

BONNET

En plastique. 4 cases. Entièrement démontable.



48512P L. 53 x l. 32,5 x H. 17 cm x 1 P.U.HT 129,00 €

### Range couverts osier

4 cases.



1000104P L. 50 x l. 30 x H. 15 cm x 1 P.U.HT 78,50 €

### Range couverts bois

En hêtre verni naturel. 4 cases. Empilable. Gastronomique 1/1.



31030 L. 52 x l. 32,5 x H. 10 cm x 1 P.U.HT 34,75 €

### Ramasse couverts bleu

SAINT ROMAIN FABRICANT PP POLYPROPYLENE

4 cases.



54401P E L. 53 x l. 32,5 x H. 10 cm x 1 P.U.HT 8,60 €  
54402P E Couverture Transparente x 1 P.U.HT 5,90 €

### Ramasse couverts gris

PP POLYPROPYLENE

4 compartiments. Sans couvercle.



1005103P E L. 53 x l. 30,2 x H. 10 cm x 1 P.U.HT 9,30 €



## INOX

### Hypinox

Corbeille à pain ou fruits en inox.



Corbeille trois angles  
**1001368P** Ø 14 x H. 5 cm x 1 **P.U. HT 9,60 €**  
**1001365P** Ø 17 x H. 7 cm x 1 **P.U. HT 12,40 €**



Corbeille perforée  
**1001367P** Ø 17 x H. 5 cm x 1 **P.U. HT 12,20 €**

### Inox fil



**1005736P** Ø 17 x H. 7,6 cm x 1 **P.U. HT 12,60 €**

### Inox ovale

En inox. Empilable.



**752P** E L. 26,5 x l. 18,5 cm x 1 **P.U. HT 5,30 €**  
**753P** E L. 31 x l. 21,5 cm x 1 **P.U. HT 6,50 €**

## BOIS

nouveau !

### Corbeille

En bois de pin. Corbeille de table avec séparateurs amovibles, avec compartiments (7,5 x 7,5 cm). A utiliser avec un papier alimentaire pour présentation des pains.



Bois blanc vieilli  
**1013525** L. 27 x l. 17 x H. 10 cm x 1 **P.U. HT 26,25 €**  
**1013524P** L. 17 x l. 17 x H. 10 cm x 1 **P.U. HT 20,25 €**

## MÉTAL

### Bouclé

Corbeille à pain ou fruits, en métal filé, époxy noir.



Rectangulaire  
**1008114P** E L. 20 x l. 11,5 x H. 4 cm x 6 **P.U. HT 7,50 €**



Ovale  
**1008112P** E L. 22 x l. 14 x H. 5 cm x 6 **P.U. HT 7,50 €**

nouveau !



Ronde  
**1013650P** Ø 15 x H. 5 cm x 1 **P.U. HT 5,80 €**



Ronde  
**1008113P** E Ø 20 x H. 5 cm x 6 **P.U. HT 7,50 €**

### Artisan

Corbeille à pain ou fruits en métal filé époxy noir.

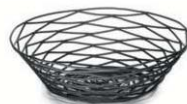

**1008111P** Ø 20 x H. 5 cm x 6 **P.U. HT 6,90 €**

nouveau !



Ronde  
**1013651P** Ø 15 x H. 5 cm x 1 **P.U. HT 6,30 €**



**1008110P** L. 23 x l. 10 x H. 5 cm x 6 **P.U. HT 5,30 €**

### Métal noir ovale

En métal grillagé.



**58279P** L. 23 x l. 10 x H. 8 cm x 1 **P.U. HT 4,80 €**



## TEXTILE

### Artiss

En coton. Lavage en machine 30°C. Ø 17 x H. 8 cm.



Gris / Crème  
**1004266P** E x 1 **P.U. HT 9,10 €**



Gris foncé / Crème  
**1004267P** E x 1 **P.U. HT 9,10 €**



Gris foncé / Vert  
**1004269P** E x 1 **P.U. HT 9,10 €**



Gris foncé / Orange  
**1004268P** E x 1 **P.U. HT 9,10 €**

nouveau !

### Sonoclean

En tissu PVC souple. Corbeille en forme de cornet. Imperméable. Lavable à l'éponge.



Corbeille Ø 10 cm  
**1013640P** Cacao/grège x 6 **P.U. HT 11,90 €**  
**1013639P** Gris / beige x 6 **P.U. HT 11,90 €**





## POLYPROPYLENE

### Classic

Lavable en machine, passe au micro-ondes et sous lampe chauffante jusqu'à 65°C.



Ovale L. 24 x l. 15 x H. 5 cm  
**1011073P** E Rouge x 6 P.U.HT 0,70 €  
**1011074P** E Noir x 6 P.U.HT 0,70 €



Ovale L. 22 x l. 15 x H. 4 cm  
**1011070P** Rouge x 6 P.U.HT 0,85 €  
**1011072P** Noir x 6 P.U.HT 0,85 €

## POLYPROPYLENE TRESSÉ

### Twiggy noir



Corbeille ronde  
**68030P** E Ø 20 x H. 7 cm x 1 P.U.HT 6,70 €



Corbeille carrée  
**68032P** E L. 19 x l. 19 x H. 7,6 cm x 1 P.U.HT 7,60 €

### Naturel



Corbeille ovale  
**53384P** L. 18 x l. 13 x H. 6,5 cm x 12 P.U.HT 3,30 €  
**40674P** E L. 23 x l. 15 x H. 6,5 cm x 12 P.U.HT 2,80 €



Corbeille ronde  
**50385P** Ø 18 x H. 6,5 cm x 12 P.U.HT 2,80 €  
**40672P** E Ø 21 x H. 6,5 cm x 12 P.U.HT 2,70 €

## BAMBOU

### Bambou

Corbeille en bambou naturel tressé.



**1006787P** Ronde - Ø 15 x H. 6 cm x 1 P.U.HT 1,20 €  
**1006786P** Ronde - Ø 20 x H. 7 cm x 1 P.U.HT 1,20 €  
**1006789P** Ovale - L. 19,5 x l. 15 x H. 6 cm x 1 P.U.HT 1,30 €



Corbeille ovale  
**1000100P** L. 22 x l. 16 x H. 9,5 cm x 1 P.U.HT 5,30 €

Corbeille ronde  
**1000101P** Ø 20 x H. 8,5 cm x 1 P.U.HT 5,30 €

### nouveau !

### Papier ingraissable

Papier ingraissable brun impression journal pour panier et cornet frites. Epaisseur 40g/m<sup>2</sup>.



Paquet de 1000  
**1014119P** L. 20 x l. 25 cm x 1 P.U.HT 11,50 €

### Corbeille kraft SERAX

Papier kraft multi-couches.

Avantages :

- résistant, ne se déchire pas.
- hauteur modulable, par simple pliage des bords.
- produit naturel.



**1013520P** Ø 11 x H. 12 cm x 12 P.U.HT 4,70 €

## ACCESSOIRES

### Ramasse miettes

En inox.



**53359P** L. 13 x l. 2 cm x 1 P.U.HT 1,30 €



**40701** L. 15,2 cm x 1 P.U.HT 5,20 €

### nouveau !

### Planche à pain

Planche à découper, 2 pièces, bords inox mat. Bois traité antidérapant.



**1013671** L. 48 X l. 32 x H. 2 cm x 1 P.U.HT 49,25 €

### Planche à pain

Bois traité antidérapant.



**1013713P** L. 47 X l. 32 x H. 2 cm x 1 P.U.HT 24,25 €



**Des mécanismes garantis à vie**

- Les épices étant très variées, Peugeot a développé un mécanisme spécifique pour chacune d'elles. Ainsi, elles peuvent libérer le meilleur de leur arôme.
- Poivre : le mécanisme à poivre est muni d'une double rangée de dents hélicoïdales qui capture les grains, les entraîne vers le bas, puis les bloque afin de les moudre parfaitement.
- Sel : le mécanisme à sel est conçu pour moudre du gros sel blanc. Réalisé en acier inoxydable, il est protégé de la corrosion saline.



Poivre



Sel

**U Select** Système breveté de réglage de la mouture.

- Réglages prédéfinis : il suffit de tourner la bague placée à la base du moulin et de sélectionner l'une des positions, chacune correspondant à une mouture précise.
- Réglage traditionnel : un bouton de réglage est situé sur la tête des moulins manuels et sous le mécanisme pour les moulins électriques.

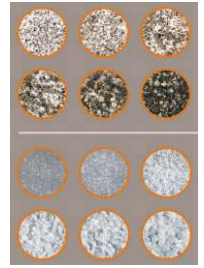
**Paris Chef****U Select**

Made in France

Moulin Paris, forme traditionnelle et emblématique de Peugeot. La finition inox brossé donne au moulin un rendu très qualitatif et soigné. Un point sur le bouton indique l'épice (noir pour le poivre et blanc pour le sel). Ce moulin de par les matériaux utilisés, sa conception, est conçu pour répondre aux utilisateurs les plus exigeants. Il n'a pas peur du chaud, du froid, de l'humidité et des chocs. Moulin Made in France, le drapeau tricolore est mis en avant sur le facing de l'emballage. Le système U'select breveté permet un réglage précis de la mouture.



Moulin à poivre

**1011187** H. 18 cm  
**1011188** H. 22 cm  
**1011189** H. 30 cm



x 1

**P.U.HT**

**40,00 €**  
**44,00 €**  
**56,00 €**

**Bistro Chef**

Made in France

Moulin Bistro, forme traditionnelle et emblématique de Peugeot. La finition inox brossé donne au moulin un rendu très qualitatif et soigné. Un P ou un S sur le corps du moulin indique s'il s'agit d'un moulin à Sel ou à Poivre. Ce moulin de par les matériaux utilisés, sa conception, est conçu pour répondre aux utilisateurs les plus exigeants. Il n'a pas peur du chaud, du froid, de l'humidité et des chocs. Moulin Made in France, le drapeau tricolore est mis en avant sur le facing de l'emballage.



Moulin à sel

**1011186** H. 10 cm

x 1

**P.U.HT****27,25 €**

Moulin à poivre

**1011185** H. 10 cm

x 1

**P.U.HT****27,25 €****Daman****U Select**

Made in France

En inox et acrylique. Design contemporain. Remplissage facilité : bouchon aimanté, pas d'axe au centre du moulin.



Moulin à sel

**64392P** H. 16 cm

x 6

**P.U.HT****42,25 €**

Moulin à poivre

**64391P** H. 16 cm

x 6

**P.U.HT****42,25 €****Shaker sel/Moulin poivre**

En inox.



Shaker à sel

**68029P** H. 13 cm

x 1

**P.U.HT****8,80 €**

Moulin à poivre

**68028P** H. 13 cm

x 1

**P.U.HT****8,80 €**

## BOIS



# PARIS

### Paris

En bois chocolat.

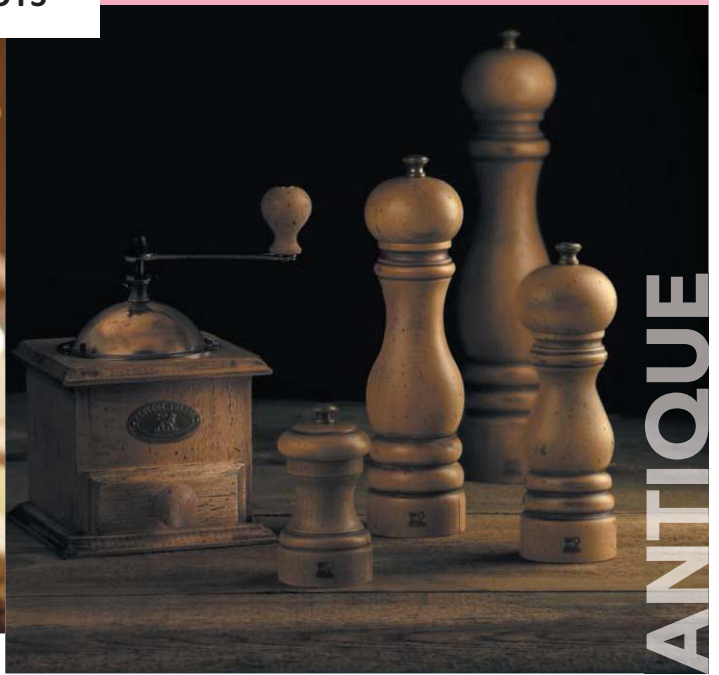

# ANTIQUE

### Antique

Moulins en bois (Hêtre), finition antique – Bouton en Laiton.



Moulin à poivre

	H.	x	P.U.HT
59568P	18 cm	x1	25,25 €
59567P	22 cm	x1	28,25 €
59566P	30 cm	x1	38,00 €
59565P	40 cm	x1	52,00 €



	H.	x	P.U.HT
Moulin à sel 1007057	22 cm	x1	41,50 €
Moulin à poivre 1007058	22 cm	x1	41,50 €

### Bistro

En bois.



	H.	x	P.U.HT
Moulin à sel naturel 40058P	10 cm	x1	16,75 €
Moulin à poivre chocolat 59594P	10 cm	x1	16,75 €

### Shaker sel/Moulin poivre

Ensemble en bois laqué, classique et intemporel.



	H.	x	P.U.HT
Shaker à sel 68025P	12 cm	x1	10,90 €
Moulin à poivre 68024P	14 cm	x1	10,60 €





# NANCY



# BALTIC

## ACRYLIQUE

### Pontarlier

En acrylique.  
Combiné sel / poivre carré.



Moulin à poivre/sel  
**59597P** H. 15 cm x 1 **P.U.HT 27,25 €**

### Nancy

En acrylique.



Moulin à sel  
**40068P** E H. 12 cm x 1 **P.U.HT 24,75 €**



Moulin à poivre  
**40067P** E H. 12 cm x 1 **P.U.HT 24,75 €**



### Baltic

En acrylique.



Moulin à sel  
**68698P** H. 8 cm x 1 **P.U.HT 22,75 €**



Moulin à poivre  
**68699P** H. 8 cm x 1 **P.U.HT 22,75 €**



### Set de 2 moulins

En acrylique. Mécanisme en céramique.



Set moulin sel/poivre  
**70568P** H. 9 cm x 1 **P.U.HT 16,00 €**



### Shaker sel / Moulin poivre

Ensemble en acrylique. Classique et intemporel.



Shaker à sel  
**68027P** H. 15 cm x 1 **P.U.HT 7,90 €**



Moulin à poivre  
**68026P** H. 15 cm x 1 **P.U.HT 9,60 €**



# PEP'S ANDRÉE

MOULINS À SEL / POIVRE

## ACRYLIQUE COULEUR

### Pep's



En ABS. COMBI 2 en 1:  
Salière & Moulin à poivre.  
Forme ludique en culbuto.



Moulin à poivre/sel  
Gris - H. 8 cm

**1007059** x1 **P.U.HT 20,00 €**



Moulin à poivre/sel  
Rouge - H. 8 cm

**1007061** x1 **P.U.HT 20,00 €**



Moulin à poivre/sel  
Vert - H. 8 cm

**1007062** x1 **P.U.HT 20,00 €**

### Andrée



Corps acrylique et bouchon Soft Touch, agréables au toucher et à l'oeil. Ø 5,5 cm.



Salière / poivrière  
Vert - H. 10 cm

**1000453P** x6 **P.U.HT 8,30 €**



Moulin à poivre / sel  
Vert - H. 10 cm

**1000443P** x6 **P.U.HT 9,90 €**



Salière / poivrière  
Violet - H. 10 cm

**1000454P** x6 **P.U.HT 8,30 €**



Moulin à poivre / sel  
Violet - H. 10 cm

**1000442P** x6 **P.U.HT 9,90 €**



Salière / poivrière  
Orange - H. 10 cm

**1000452P** x6 **P.U.HT 8,30 €**



Plateau acrylique  
H. 15 cm

**1000455P** x1 **P.U.HT 7,50 €**

### Andrée 2



Corps acrylique et bouchon soft touch, agréable au toucher et à l'oeil. Ø 5,8 cm. Ne s'adapte pas au plateau Andrée 1000455.



Salière / poivrière  
Blanc - H. 8,8 cm

**1008370P** x1 **P.U.HT 5,30 €**



Moulin à poivre / sel  
Blanc - H. 10 cm

**1008367P** x1 **P.U.HT 8,90 €**



Salière / poivrière  
Noir - H. 8,8 cm

**1008371P** x1 **P.U.HT 5,30 €**



Moulin à poivre / sel  
Noir - H. 10 cm

**1008368P** x1 **P.U.HT 8,90 €**



Salière / poivrière  
Rouge - H. 8,8 cm

**1008372P** x1 **P.U.HT 5,30 €**



Moulin à poivre / sel  
Rouge - H. 10 cm

**1008369P** x1 **P.U.HT 8,90 €**



ART DE LA TABLE

## MASON



## Ménagère

En porcelaine blanche.

Ménagère 3 pièces S/P/M  
58238P H. 8 cm

x 1

P.U.HT  
6,50 €

nouveau !

## Clip

En verre et inox. Look moderne avec sa forme bocal.

Salière / poivrière  
1013647P 4,5 cl - H. 6,35 cm

x 6

P.U.HT  
2,20 €

## Mini Mason

En verre et inox.

Salière / poivrière  
1013646P 4,4 cl - H. 6,5 cm

x 12

P.U.HT  
1,30 €

## Up &amp; Go

Original ! La poivrière s'insère dans la salière.  
En porcelaine renforcée ultra-blanche.Salière et poivrière  
68242P H. 7 cm

x 12

P.U.HT  
5,70 €1<sup>er</sup> PRIX

## Éco

En verre avec couvercle inox à visser.

Salière / poivrière  
59083P E 5 cl - H. 9 cm

x 12

P.U.HT  
1,70 €

## Tour eiffel

En verre. Bouchon en inox.

3,5 cl - H. 11 cm  
1002255P E Salière  
1002256P E Poivrière

x 12

x 12

P.U.HT  
1,20 €  
1,20 €

## La parfaite

En verre. Bouchon métal argenté.

H. 14 cm  
52638P Verre salière / poivrière seul  
53083P Bouchon salière / poivrière

x 6

x 10

P.U.HT  
3,70 €  
7,10 €

## America

En verre. Bouchon inox.

Salière / poivrière  
59085P 8 cl - H. 10 cm

x 1

P.U.HT  
1,50 €

## Cube

Forme cubique en verre avec couvercle métal chromé à visser.

Salière / poivrière  
1008124P 1,5 cl - Ø 2,9 x H. 5 cm

x 24

P.U.HT  
0,50 €

nouveau !

**Siena**

En verre et inox.  
Support en métal chromé.



Ménagère 2 pièces H/V  
**1013648** H. 24,1 cm x 1 P.U.HT **26,00 €**

**Modern**

En verre et métal chromé.



Ménagère 2 pièces H/V  
**1014075** H. 21,6 cm x 1 P.U.HT **13,60 €**

**European**

En verre et inox.  
Support en métal époxy noir.



Ménagère 2 pièces H/V  
**1014072** H. 23,2 cm x 1 P.U.HT **7,40 €**

**Pure**

Set apéritif 4 pièces : 1 support inox mat  
+ 4 coupelles mélamine blanche  
(9 x 9 x H 4 cm).



Présentoir  
**1013531P** L. 17 x l. 17 x H. 16 cm x 1 P.U.HT **26,25 €**

**Nova**

En verre et inox.



Ménagère 3 pièces S/P/M  
**66564P** H. 11,5 cm x 1 P.U.HT **11,40 €**



Ménagère 2 pièces H/V  
**66563P** H. 19 cm x 1 P.U.HT **14,60 €**



Ménagère 2 pièces S/P  
**66562P** H. 13 cm x 1 P.U.HT **6,70 €**

**1er PRIX**

**Eco**

En verre et inox.



Ménagère 3 pièces S/P/M  
**54037P** E H. 13 cm x 1 P.U.HT **9,60 €**



Ménagère 2 pièces H/V  
**54039P** E H. 22 cm x 1 P.U.HT **12,30 €**



Ménagère 2 pièces S/P  
**54038P** E H. 13 cm x 1 P.U.HT **6,40 €**  
Salière / poivrière  
**59083P** E H. 9 cm x 12 P.U.HT **1,70 €**

nouveau !

**Minimax**

En porcelaine crème. Avec couvercle.



**1013578** 12 cl x 12 P.U.HT **4,00 €**

**Porcelaine**



Corps moutardier  
**69544P** H. 4,9 cm - 9 cl x 12 P.U.HT **2,90 €**  
Couvercle seul  
**69545P** Ø 6,2 cm x 12 **4,50 €**

nouveau !

**Moutardier**

En inox et verre.  
Cuillère et couvercle inclus.



Paquet de 2  
**1013522P** Ø 5 x H. 6 cm x 1 P.U.HT **5,10 €**

**Cuillère**



Cuillère porcelaine  
**69546P** x 12 P.U.HT **1,60 €**



Spatule bois - Sachet de 10  
**47693P** L. 11 cm x 1 P.U.HT **12,90 €**

**Pot à cornichons**

En grès.



**44054P** Ø 12,5 x H. 14,5 cm - 100 cl x 1 P.U.HT **10,90 €**



HUILE / VINAIGRE

**Spray**

En inox et verre.



Spray huile ou vinaigre  
 1002257P H. 19,3 cm - 17 cl



P.U.HT  
 12,00 €

**Pot Lyonnais**

En verre sodocalcique.



Pot lyonnais seul  
 1818P H. 29 cm - 46 cl



P.U.HT  
 4,60 €

**Bec verseur**

1001405P En inox et silicone



P.U.HT  
 2,70 €

**Optima**

En verre blanc transparent en forme de burette.  
 Bouchon silicone avec bec verseur inox.



Huilier  
 1002470P H.14,3 cm - 25 cl



P.U.HT  
 3,50 €

Vinaigrier  
 1007101P H.14,3 cm - 25 cl



P.U.HT  
 3,50 €

**nouveau !**

**European**

Bouteille pour huile ou vinaigre avec bec verseur inox.



Bouteille  
 1014073P Ø 5,08 x H. 15 cm - 18 cl



P.U.HT  
 1,90 €

**Siena**

Bouteille pour huile ou vinaigre avec bec verseur inox.



Bouteille  
 1014074P Ø 6,2 x H. 21,3 cm - 18 cl



P.U.HT  
 7,30 €

**Modern**

Bouteille pour huile ou vinaigre avec couvercle en plastique ABS chromé.



Bouteille  
 1013649P Ø 7,8 x H. 17,5 cm - 13,6 cl



P.U.HT  
 4,10 €

**nouveau !**

**Elixir**

En verre sodocalcique. Mini-bouteille carrée avec bouchon bec verseur bi-matière liège et inox.



Dash bottle  
 1013244 L. 5,7 x l. 5,7 x H. 13,5 cm - 10 cl



P.U.HT  
 5,50 €

**SUCRE**

**Saupoudreuse**

En verre. Bouchon inox



59090P Ø 7,5 x H. 13,5 cm



P.U.HT  
 5,80 €

**Doseur**

En verre. Bouchon inox



59089P Ø 7,5 x H. 16,5 cm



P.U.HT  
 5,30 €

**FROMAGE**

**Saupoudreuse parmesan**

En verre, bouchon inox.



59088P Ø 7,5 x H. 13,5 cm



P.U.HT  
 6,40 €

**Fromagère**

En verre avec couvercle et support en inox 18/0.



Fromagère avec couvercle et cuillère

1005710P Ø 11 x H. 7 cm - 15 cl



P.U.HT  
 16,00 €

Verre de rechange

1005711P



P.U.HT  
 4,70 €

**nouveau !**

**Distributeur à miel / sirop**

Pot verseur universel pour le miel, le lait, la crème.



Distributeur à miel / sirop  
 1013523P Ø 8,5 x H. 13,5 cm - 30 cl



P.U.HT  
 6,70 €



## Pichet

En copolyester.



Sans Bisphénol A

Pichet 50 cl gradué tous les 10 ml

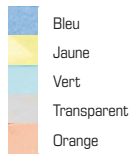

	Pichet 1,5 L sans couvercle	Pichet 1 L sans couvercle	Pichet 50 cl sans couvercle
Bleu	70710P E	70778P E	70722 E
Jaune	70712 E	70780 E	70724 E
Vert	70714P E	70782 E	70726 E
Transparent	70709P E	70777P E	70721 E
Orange	70713 E	70781 E	70725 E
	x 8	x 8	x 8
<b>P.U.HT</b>	<b>11,30 €</b>	<b>10,80 €</b>	<b>9,90 €</b>



	Couvercle pour pichet 1,5 L	Couvercle pour pichet 1 L	Couvercle pour pichet 50 cl
Bleu	70716 E	70784P E	70728 E
Jaune	70718 E	70787 E	70730 E
Vert	70720 E	70788 E	70732 E
Transparent	70715 E	70783P E	70727 E
Orange	70719 E	70786 E	70731 E
	x 8	x 8	x 8
<b>P.U.HT</b>	<b>3,70 €</b>	<b>3,20 €</b>	<b>1,40 €</b>

## Carafe à débit régulé

En copolyester. Au design contemporain, cette carafe possède un bec verseur à régulation et anti-goutte. Grande stabilité grâce à sa base antidérapante. Sans phtalate, sans bisphénol A.



Sans Bisphénol A



	Carafe 50 cl		<b>P.U.HT</b>
Orange	1000091 E	x 4	<b>13,10 €</b>
Bleu	1000089 E	x 4	<b>13,10 €</b>
Cassis	1000090 E	x 4	<b>13,10 €</b>
Transparent	1000092 E	x 4	<b>13,10 €</b>

## Pichet

Matériau évitant le développement rapide des bactéries, résistant aux chocs.



			<b>P.U.HT</b>
Bleu	58589	50 cl x 8	<b>11,10 €</b>
	58587	100cl x 8	<b>12,20 €</b>
Couvercle bleu	58593	50 cl x 24	<b>P.U.HT 1,50 €</b>
	58591	100cl x 24	<b>3,60 €</b>
Vert	58590	50 cl x 8	<b>P.U.HT 11,10 €</b>
	58588	100cl x 8	<b>12,20 €</b>
Couvercle vert	58594	50 cl x 24	<b>P.U.HT 1,50 €</b>
	58592	100 cl x 24	<b>3,60 €</b>

## Carafe copolyester

Transparent.



Sans Bisphénol A



			<b>P.U.HT</b>
Carafe avec couvercle	1006585P	E 50 cl x 1	<b>10,40 €</b>
	1006584P	E 100 cl x 1	<b>14,90 €</b>

## Pichet plastique



34043P	E 150 cl	x 1	<b>P.U.HT 7,20 €</b>
--------	----------	-----	----------------------

## Pichet

En SAN transparent.



Sans Bisphénol A

1006610P	E 95 cl	x 1	<b>P.U.HT 6,80 €</b>
1006609P	E 140 cl	x 1	<b>8,50 €</b>
1006608P	E 180 cl	x 1	<b>9,90 €</b>

## Pot inox

Pichet à bec verseur.



			<b>P.U.HT</b>
Pichet non empilable	61536P	100 cl x 1	<b>24,25 €</b>
	61537P	150 cl x 1	<b>28,00 €</b>



			<b>P.U.HT</b>
Pichet empilable	61534P	E 100 cl x 1	<b>19,75 €</b>
	61535P	E 150 cl x 1	<b>21,50 €</b>

## Pichet isotherme

Conteneur de maintien en température chaud et froid.



			<b>P.U.HT</b>
Ø 26 x H. 52 cm - 5 L	Orange	1007361 E x 1	<b>260,00 €</b>
	Bleu	1007362 E x 1	<b>260,00 €</b>

## Pot isotherme jazz

Pot isotherme blanc avec couvercle. Idéal en milieu hospitalier.



62122P	E 27 cl	x 1	<b>P.U.HT 11,70 €</b>
--------	---------	-----	-----------------------



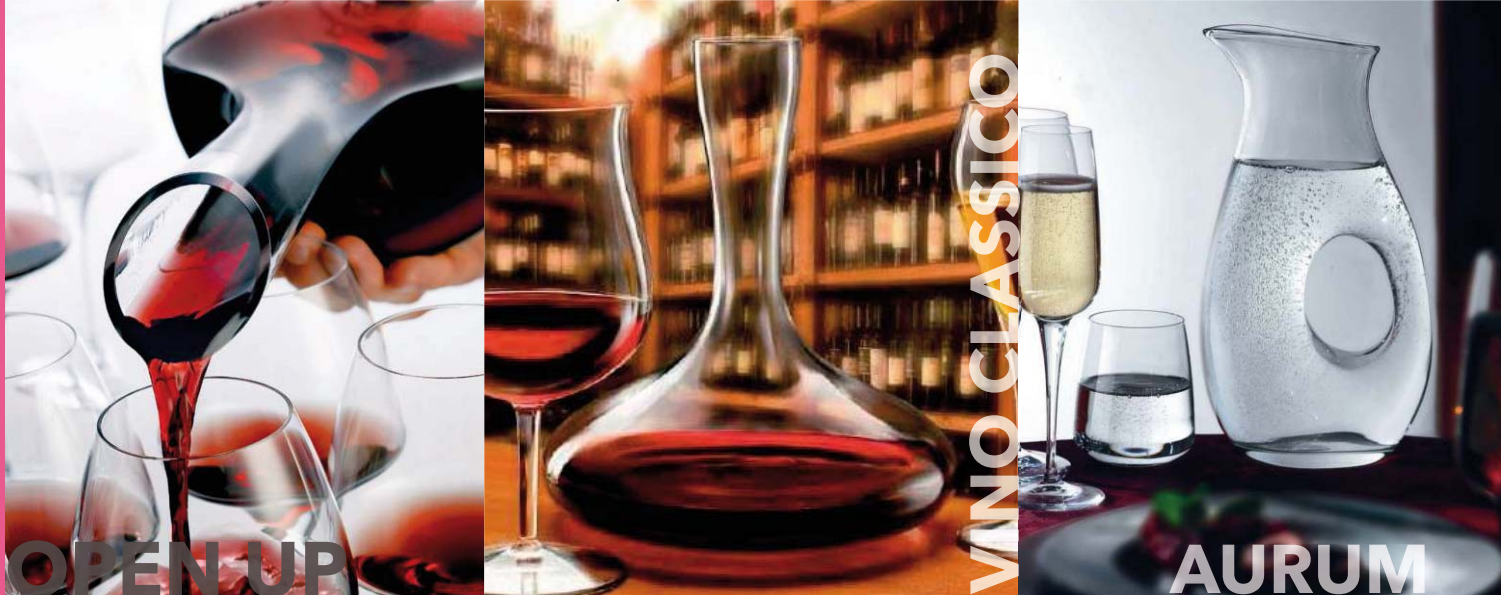

CARAFES À DÉCANTER

Ibis

En verre soufflé bouche.



**56684P** 75 cl - Ø 17  
x H. 27 cm

x1 **P.U.HT**  
**54,50 €**

Open Up

En verre soufflé bouche. Col Drop control.



**1004298P** 140 cl - Ø 14,5  
x H. 31,4 cm

x2 **P.U.HT**  
**39,50 €**

Explore

En verre artisanal soufflé bouche.  
Col Drop control.



**61181P** 130 cl - Ø 14,5  
x H. 32,3 cm

x2 **P.U.HT**  
**35,25 €**

Vino classico

En verre soufflé bouche.



**62272P** 200 cl - Ø 22  
x H. 25 cm

x1 **P.U.HT**  
**23,75 €**

CARAFES ET PICHETS

Aurum

En verre soufflé bouche.



**59510P** 150 cl  
H. 30 cm

x6 **P.U.HT**  
**35,50 €**

Hypinox

En inox.



**1006153P** 100 cl  
H. 23,3 cm

x1 **P.U.HT**  
**29,00 €**

Michelangelo

En verre soufflé bouche.



**50660** 150 cl  
H. 26,2 cm

x4 **P.U.HT**  
**20,50 €**

Craquelée

En verre soufflé bouche. Fait main.



**2134P** 45 cl  
H. 18 cm  
**2133P** 75 cl  
H. 22 cm

x6 **P.U.HT**  
**12,50 €**  
x6 **18,25 €**

## Viva

En verre sodocalcique avec colonne pour insérer des glaçons et maintenir au frais.



62770P 200 cl - H. 21,1 cm

x 6 P.U.HT  
8,00 €

## Pichet

En verre sodocalcique.

ARCOROC



2130P 25 cl - H. 12,5 cm  
2129P 50 cl - H. 14,6 cm  
2128P 130 cl - H. 21,7 cm

x 12 P.U.HT  
4,80 €  
x 6 P.U.HT  
6,00 €  
x 6 P.U.HT  
6,80 €

## Tivoli

En verre sodocalcique.

ARCOROC



40161 160 cl - H. 20,3 cm  
32047P 230 cl - H. 25,7 cm

x 6 P.U.HT  
3,90 €  
x 6 P.U.HT  
5,10 €

## Budelle

En verre sodocalcique.

La Rochère



40451 50 cl - H. 24,3 cm

x 6 P.U.HT  
8,50 €

## Conica

En SON.hyx.



59536P 25 cl - H. 15,6 cm  
59535P 50 cl - H. 19,5 cm  
59534P 100 cl - H. 24,5 cm

x 12 P.U.HT  
2,90 €  
x 12 P.U.HT  
3,90 €  
x 6 P.U.HT  
6,70 €

## Ypsilon

En Star glass.



57215P 25 cl - H. 16,5 cm  
57216P 50 cl - H. 20,4 cm  
57217P 100 cl - H. 25,5 cm

x 12 P.U.HT  
2,20 €  
x 12 P.U.HT  
2,90 €  
x 6 P.U.HT  
5,30 €

## Misura

En verre sodocalcique avec jauge.



40155P 25 cl - H. 19 cm  
40156P 50 cl - H. 23,5 cm  
40157P 100 cl - H. 26,2 cm

x 12 P.U.HT  
2,10 €  
x 12 P.U.HT  
2,90 €  
x 6 P.U.HT  
3,60 €

## Fluid

En verre sodocalcique. Bouchon adapté pour carafe 50, 75 cl et 1L.

ARCOROC



1008354P E 25 cl - H. 13,5 cm  
1008355P E 50 cl - H. 19,3 cm  
1011439 E 75 cl - H. 21 cm  
1008356P E 100 cl - H. 26,5 cm  
1010271 E Bouchon Ø 7 cm

x 12 P.U.HT  
2,50 €  
x 6 P.U.HT  
2,90 €  
x 6 P.U.HT  
4,20 €  
x 6 P.U.HT  
5,00 €  
x 24 P.U.HT  
0,87 €

## Carrée

En verre sodocalcique.

ARCOROC



2127P E 25 cl - H. 16,2 cm  
2126P E 50 cl - H. 19,9 cm  
2125P E 100 cl - H. 25,5 cm

x 12 P.U.HT  
1,30 €  
x 12 P.U.HT  
1,70 €  
x 6 P.U.HT  
2,90 €

## 1er PRIX

### Santiano

En verre sodocalcique.



Jaugé  
70201P E 36 cl - H. 13 cm  
70200P E 59 cl - H. 15,3 cm  
70199P E 114 cl - H. 19,2 cm

x 12 P.U.HT  
1,70 €  
x 6 P.U.HT  
1,80 €  
x 6 P.U.HT  
3,00 €

## 1er PRIX

### Soufflée

En verre sodocalcique.

ARCOROC



2138P E 25 cl - H. 13,2 cm  
2137P E 50 cl - H. 16,4 cm  
2136P E 100 cl - H. 20,3 cm

x 12 P.U.HT  
1,10 €  
x 12 P.U.HT  
1,30 €  
x 6 P.U.HT  
2,00 €





ITALIAN TABLE STORIES



## Officina, une gamme dans l'air du temps !

Avec son design très marqué, Officina souligne les tendances du moment...  
un hommage aux influences industrielles et aussi un clin d'œil au savoir-faire de Bormioli Rocco, né en 1825.

## Sublime

ACCADEMIA Luigi Bernabè  
MADE IN ITALY

En SON.hyx. Vendu sans bouchon.



**1011384P** 112 cl x 6 **P.U.HT 5,00 €**  
H. 26,3 cm

## Optima

ACCADEMIA Luigi Bernabè  
MADE IN ITALY

Verre ultra blanc avec jauge. Col évasé qui facilite le remplissage et le versement.



**1002202P** 25 cl x 12 **P.U.HT 2,20 €**  
H. 19,6 cm

**1002201P** 50 cl x 6 **2,80 €**  
H. 26,2 cm

**1002203P** 75 cl x 6 **2,90 €**  
H. 26 cm

nouveau !

## Eau communale



En verre sodocalcique. Avec bouchon à vis.



**1013439P** 70 cl x 6 **P.U.HT 3,90 €**  
H. 31,3 cm

## H2O



En verre sodocalcique. Avec bouchon à vis.



**1013438P** 70 cl x 6 **P.U.HT 3,90 €**  
H. 22,8 cm

## Giara



Bouteille en verre avec bouchon hermétique en plastique.



**63651P** 100 cl - x 6 **P.U.HT 3,00 €**  
H. 30,6 cm

## Swing



Bouteille en verre type limonade à fond carré avec fermeture hermétique.



Bouteille transparente **P.U.HT**

**68315P** 25 cl x 28 **2,00 €**  
H. 20 cm

**68316P** 50 cl x 12 **2,40 €**  
H. 25,3 cm

**1009595P** 100 cl x 6 **2,50 €**  
H. 31,5 cm

Bouteille avec effet givré **P.U.HT**

**1012611** 25 cl x 6 **3,10 €**  
H. 19,2 cm

**1012612P** 50 cl x 6 **3,20 €**  
H. 25,3 cm

**1012613P** 100 cl x 6 **3,60 €**  
H. 30,6 cm

## Officina 1825



Avec bouchon hermétique en plastique.



**1007478P** 120 cl x 6 **P.U.HT 4,20 €**  
H. 30 cm

## Quattro Stagioni



Bouteille avec bouchon à vis.



**1007029P** 100 cl x 12 **P.U.HT 2,10 €**  
H. 22,6 cm

## Pot Lyonnais

En verre sodocalcique.



**48577P** 25 cl x 6 **P.U.HT 4,40 €**  
H. 22,4 cm

**1818P** 46 cl x 6 **4,60 €**  
H. 29 cm

nouveau !

## Konik



Pichet en porcelaine blanche.



**1013129P** 13 cl x 6 **P.U.HT 4,60 €**

**1013128P** 25 cl x 4 **6,00 €**

**1013127P** 50 cl x 1 **10,60 €**

## Porcelaine

En porcelaine blanche.



**58574P** 100 cl x 4 **P.U.HT 23,00 €**  
H. 19 cm

## Parisien

En grès coloris noisette.



**62167P** 100 cl x 6 **P.U.HT 11,20 €**

**62168** 50 cl x 6 **7,50 €**

## Greenwich

En grès crème.



**68776P** 120 cl x 6 **P.U.HT 9,10 €**

## Grès

En grès écru.



**1002465P** 25 cl x 6 **P.U.HT 4,80 €**

**1002466P** 50 cl x 4 **6,50 €**

**1002467P** 100 cl x 2 **9,10 €**



BILLY

FEEL

BOUGIE  
LED**Ruby**
**ADS:**  
Ambiance Design Solution  
GARANTIE 1 an CE

Lampe LED avec pied aluminium et chargeur.  
7 couleurs + blanc chaud. Mode fusion +  
télécommande. Possibilité de réglage de l'intensité.  
Autonomie 10 H. 230 V. 1,2 W.



Lampe LED sur pied  
**1011318** Ø 12 x H. 24 cm x 1 **P.U.HT**  
**66,50 €**

nouveau !

**Feel**
**Duni**

Fait à la main en carton 100 % recyclé. Uniquement  
pour bougie LED (non comprises). Ne pas utiliser  
avec une flamme.



Photophore pour LED  
**1013206P** Ø 12 x H. 11 cm x 4 **P.U.HT**  
**5,20 €**

**Onyx**
**Duni**

Un produit fait à la main en pierre naturelle, chaque  
bougeoir est unique. Uniquement pour bougie LED  
(non comprise) et chauffe-plats.



Photophore pour LED  
**1013159P** Ø 7 x H. 12,5 cm x 4 **P.U.HT**  
**4,60 €**

nouveau !

**Bougie LED**
**Duni**  
GARANTIE 1 an CE

En cire. 230 V. Livrées avec 1 socle chargeur, 1  
adaptateur et 1 télécommande.



Kit de 4 bougie LED  
**1013160P** Ø 7,5 x H. 12,5 cm x 1 **P.U.HT**  
**112,00 €**

**Bougie LED**
**Duni**  
GARANTIE 1 an CE

Livré avec 1 socle chargeur, 1 adaptateur  
et 1 télécommande. 230 V.



Kit de 12 bougies LED multicolores  
**1012539P** Ø 4 x H. 7 cm x 1 **P.U.HT**  
**134,00 €**

nouveau !

**Billy**
**Duni**

En métal. Uniquement pour bougie LED (non com-  
prise) et chauffe-plats.



Photophore pour LED - Ø 7,5 x H. 14 cm

**1013158P** Noir x 4 **P.U.HT**  
**6,20 €**  
**1013153P** Blanc x 4 **P.U.HT**  
**6,20 €**

ONYX

**Bougie LED**
**ADS:**  
Ambiance Design Solution  
GARANTIE 1 an CE

Bougie LED avec photophore et base de chargement.  
Autonomie 8 H.



Set de 12 bougies  
**1011321P** Ø 4,7 x H. 3,5 cm x 1 **P.U.HT**  
**54,00 €**



NÉON  
LED

YAGO



## Néon rechargeable

Néon LED 5W rechargeable. Sélection de l'intensité et switch on/off. Fixation par aimant ou avec le kit de fixation fourni.  
Multi-couleurs : rouge, orange, jaune (1011327)  
Pas de protection pour les liquides.

ADS: **GARANTIE 1 an** CE

Sans fil



**1011325** Blanc Ø 4 x L. 34 cm



x 1

**P.U.HT**  
**68,00 €**

**1011327** Multi-couleurs Ø 4 x L. 34 cm



x 1

**P.U.HT**  
**93,00 €**

## Clip led

Dispositif d'éclairage nomade de deux ampoules avec batterie rechargeable et un support qui vous permettra de l'accrocher simplement ou bon vous semble et de la recharger facilement. 32 leds.  
Eclairage sur 120°. Tension : 85-265V  
Temps de charge : 8 heures.  
Temps de durée de son autonomie (réglable avec la télécommande) :  
100% = 4W Autonomie 4 heures 30 Minutes  
75% = 3W Autonomie 6 heures 30 Minutes  
50% = 2W Autonomie 8 heures 30 Minutes  
25% = 1W Autonomie 10 heures 30 Minutes

ADS: **GARANTIE 1 an** CE



**1011324** 2 x 4 W - E27



x 1

**P.U.HT**  
**95,50 €**

## Coco

Sockette nickelée mat.

CANDOLA  
Créateurs d'Ambiance



**60069** H. 17,5 cm



x 1

**P.U.HT**  
**37,50 €**

nouveau !

## Yago

Sockette en métal.

CANDOLA  
Créateurs d'Ambiance



Piccolo **A**

**B**

**C**

Photophore Ø 6,5 cm

**A 1013497P**

Métal nickelé H. 11 cm



x 6

**P.U.HT**

**B 1013496P**

Métal argenté H. 15,5 cm



x 6

**11,80 €**

**C 1013495**

Métal cuivré H. 15,5 cm



x 6

**11,80 €**

Le système modulaire et polyvalent de Candola produit grâce à une flamme authentique une lumière magnifique et naturelle, propre, sans odeur, pas dangereux et écologique. Une mèche permanente brûle le liquide spécial de Candola pendant 40 à 120 heures selon le type de recharge utilisé. Sans suie ni fumée ! La bouteille vide peut être remplacée de façon simple et rapide.



## Recharge



**A**

Recharge anti-insectes et sans odeur disponible pour les terrasses l'été, nous consulter



**B**

**A 56301P**

Recharge 35 h pour lampe Coco / Yago x 24



x 24

**P.U.HT**

**4,80 €**

**B 1013498P**

Recharge 20 h pour lampe Piccolo x 40



x 40

**2,40 €**

## LA NOUVELLE FLAMME NATURELLE

- RECHARGE D'HUILE MINÉRALE
- NE FUME PAS ET NE NOIRCIT PAS
- SÉCURITÉ : LA FLAMME S'ÉTEINT SI LA LAMPE SE RENVERSE

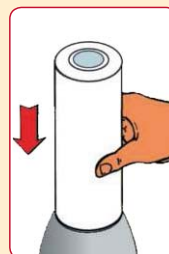
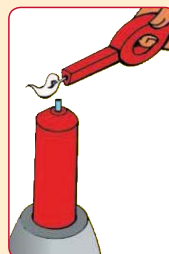

## Highlight

SPAAS  
light up your life

En verre. Pour bougies rechargeables Ø 5,5 cm.  
Bougie non fournie.



Ø 7,2 x H. 9,8 cm - Paquet de 6

<b>1000736P</b>	Rouge	x 1	<b>30,25 €</b>
<b>1000733P</b>	Anthracite	x 1	<b>30,25 €</b>
<b>1000737P</b>	Transparent	x 1	<b>30,25 €</b>



Durée 24 H



Bougie  
Ø 5 x H. 6 cm - Carton de 60

<b>62012P</b>	Blanche	x 1	<b>40,75 €</b>
<b>62013P</b>	Rouge	x 1	<b>40,75 €</b>

## Bougie fumeur

SPAAS  
light up your life

Donnez une ambiance chaleureuse à votre établissement grâce à cette bougie cylindre classique.



Durée 13 H



Ø 4 x H. 11 cm. Boîte de 20

<b>1006671P</b>	Blanche	x 4	<b>17,25 €</b>
-----------------	---------	-----	----------------

## Bougie flottante

SPAAS  
light up your life

Bougies flottantes pour des centres de table liant charme et féérie. Une décoration originale pour des occasions spéciales.



Durée 4,5 H



Ø 4,6 x H. 2,9 cm. Boîte de 10

<b>1000723P</b>	Blanche	x 1	<b>3,70 €</b>
-----------------	---------	-----	---------------

## nouveau !

### Mosaic

SPAAS  
light up your life

En verre. Photophore à facettes créant un joli dessin lumineux sur la table. Pour bougies rechargeables Ø 5,5 cm max (type 20 H) ou chauffe-plat. Facile à nettoyer, ré-utilisable. Livré avec 1 recharge 20h.



Ø 6 x H. 6,5 cm

<b>1013511P</b>	Anthracite	x 6	<b>2,30 €</b>
<b>1013510P</b>	Transparent	x 6	<b>2,30 €</b>
<b>1013512P</b>	Bordeaux	x 6	<b>2,30 €</b>

## Votive

DECO  
candle

Photophore de table rond en verre. Couleurs pulvérisées intérieur. Non garanti lave-vaisselle. Non certifié contact alimentaire. Livré sans bougie chauffe-plat. Pour bougies chauffe-plat maxi 10 H.



Ø 6 x H. 6,5 cm

<b>1008012P</b>	Transparent	x 24	<b>0,75 €</b>
<b>1008009P</b>	Blanc	x 24	<b>1,20 €</b>
<b>1008011P</b>	Rouge	x 24	<b>1,20 €</b>

## Bougie chauffe plat

SPAAS  
light up your life

Idéal pour les photophores ou lumignons transparents ou de couleurs.



Durée de 4,5 à 10 H



<b>B 1004328P</b>	Ø 3,9 cm 4,5 h - Sachet de 100	x 1	<b>7,30 €</b>
<b>B 56793P</b>	Ø 3,9 cm 6 h - Sachet de 70	x 1	<b>7,00 €</b>
<b>B 61503P</b>	Ø 3,9 cm 8 h - Sachet de 50	x 10	<b>7,20 €</b>
<b>B 69199P</b>	Ø 5,5 cm 10 h - Sachet de 10	x 12	<b>3,30 €</b>

## New D Light

SPAAS  
light up your life

En verre. Partie supérieure resserrée pour une utilisation extérieure sans extinction de flamme répétée.



Durée 60 H



Ø 9 x H. 9,8 cm  
**1011770P** Rouge

x 6	<b>P.U.HT</b> <b>1,90 €</b>
-----	--------------------------------

## Soft glow

SPAAS  
light up your life

En verre mat coloré.



Durée 50 H



Ø 8,2 cm x H. 9 cm

<b>A 1000726P</b>	Ambre	x 6	<b>2,50 €</b>
<b>B 1000730P</b>	Fuchsia	x 6	<b>2,50 €</b>
<b>C 63585P</b>	Rouge	x 6	<b>2,10 €</b>
<b>D 63583P</b>	Ivoire	x 6	<b>2,10 €</b>

## Soft glow anti-moustiques

SPAAS  
light up your life



Durée 45 H



Ø 8,3 x H. 9 cm

<b>1009418</b>	Citronnelle	x 6	<b>2,40 €</b>
----------------	-------------	-----	---------------

## Terracotta

SPAAS  
light up your life

Bougie dans une vasque en terre cuite. Idéal sur vos tables d'été et moyen utilisé de longue date pour éloigner moustiques et autres insectes.



Durée 9 H  
Anti-moustiques



Ø 18 x H. 7,5 cm

<b>1009406</b>	Citronnelle	x 6	<b>3,60 €</b>
----------------	-------------	-----	---------------



## Fontaine lumineuse\*

Artifice d'intérieur produisant un jet d'étincelles pour animer vos soirées entre amis et la présentation de gâteaux et desserts. Idéal pour toutes les occasions et toutes les fêtes. Allumage instantané. L. 12 cm. Durée combustion : 60 secondes.



**1005117P\*** Paquet de 10 x 8 **P.U.HT**  
**9,20 €**  
\*Dangereux. Respecter les précautions d'emploi. Produit conforme à la législation française.

## Bougie anniversaire

Bougie et bobèche. Pack bleu, rose, jaune et blanc.

SPAAS  
light up your life



**1000725P** Boîte de 24 x 1 **P.U.HT**  
**1,10 €**

## Briquet allume bougie\*

Pour allumer les bougies et chauffe plats en toute sécurité. Tige flexible chromée. Bouton de verrouillage. Réservoir de gaz facile à remplir.



**69079\*** x 12 **P.U.HT**  
**5,20 €**  
\*Dangereux. Respecter les précautions d'emploi. Produit conforme à la législation française.

## Bougie flambeau

Ces bougies de table apportent une ambiance chaleureuse à votre intérieur.

SPAAS  
light up your life



Ne coule pas

8 h - Ø 2,3 x H. 25 cm - Boîte de 100 x 1 **P.U.HT**  
**39,50 €**  
**54305P** Blanc

## Bougie cylindre

Bougie cylindre classique.

SPAAS  
light up your life



45 h - Ø 6 x H. 15 cm x 12 **P.U.HT**  
**2,10 €**  
**1011714P** Blanc

90 h - Ø 8 x H. 20 cm x 6 **P.U.HT**  
**3,70 €**  
**1011725P** Blanc

## CENDRIERS

### Porcelaine

En porcelaine blanche robuste.



Rond x 24 **P.U.HT**  
**2,50 €**  
**53661P** Ø 8,5 cm



Rectangulaire x 12 **P.U.HT**  
**2,50 €**  
**53660P** L. 12,8 x l. 9,6 cm

## Verre

Cendrier lourd et massif, idéal pour les mises en table en extérieur.



**A 69598P** Ø 8,9 x H. 2,8 cm x 12 **P.U.HT**  
**1,40 €**  
**B 69599P** Ø 11 x H. 2,8 cm x 12 **P.U.HT**  
**1,50 €**

ARCOROC



**1437P** Ø 8,5 cm x 24 **P.U.HT**  
**0,97 €**

## Inox

Résistant à la corrosion.

pro.mund



**1001409P** Ø 8 x H. 3 cm x 1 **P.U.HT**  
**9,20 €**



Anti-vent / Usage extérieur x 1 **P.U.HT**  
**5,60 €**  
**1001408P** Ø 11 x H. 4 cm



Usage extérieur x 1 **P.U.HT**  
**5,00 €**  
**67679P** Ø 15 x H. 3 cm

## nouveau !

### Méla mine

Blanc.

APS



Cendrier anti-vent x 1 **P.U.HT**  
**5,10 €**  
**1013534P** Ø 11,5 x H. 5 cm



# Protège-menus

## Personnalisez vos tables

Présenter sa propre liste de menus ou carte des vins est pour le propriétaire du restaurant le premier impact réel avec le client, il est probablement le moment le plus représentatif de ce que vous voulez communiquer **de votre art et de votre cuisine.**

**Par conséquent, ne pas sous-estimer l'importance de cet outil, fiez-vous à ARTMENU FACTORY, la première et la seule société italienne qui depuis plus de trente ans les conçoit et produit avec le souci du détail et de la qualité artisanale.**

Une large gamme de matériaux et de couleurs, de multiples solutions de reliure intérieure en mesure de satisfaire chaque exigence de mise en page, les personnalisations conçues pour donner l'unicité du produit vous permettra de vous démarquer et de vous distinguer de la concurrence, en commençant par la liste des menus.

ARTMENU<sup>®</sup>  
FACTORY

MADE IN ITALY



## Notre carte

Modèle livré avec 5 intercalaires soit 10 faces visibles. Relié avec des vis intérieures et angles de protection argent. Impression sérigraphique deux couleurs grise et blanche. Nettoyable. Option possible d'ajout jusqu'à 5 intercalaires supplémentaires. Noir. En carton plastifié.

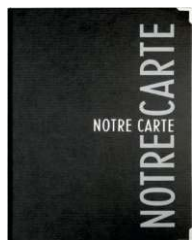

Protège-menu  
Format intérieur 29,7 x 21 cm  
L. 32 x l. 25 cm **P.U.HT**  
**68738** x 30 **19,50 €**

Carte des vins  
Format intérieur 14,8 x 21 cm  
L. 17 x l. 25 cm **P.U.HT**  
**68737** x 20 **16,25 €**

## Carte cristal

Double A4 / 4 vues avec coins métalliques.



Transparent **P.U.HT**  
**1004034P** Lot de 3 x 1 **15,25 €**

## Carte menu à pince

Carte-menu 1 page A4 à pince. Se compose d'une planchette en bois et d'une pince en métal.



Couleur naturel **P.U.HT**  
**1008408P** L. 34 x l. 23 cm x 1 **7,60 €**

## Tendance

Protège-menu A4 en polyuréthane simili cuir. Le protège-menu est livré avec une pochette transparente 4 vues format A4, maintenue grâce à un lacet élastique (la carte des vins est livrée avec deux pochettes soit 8 vues). Rajout d'intercalaire A4 : réf 1004062.



Noir **P.U.HT**  
**1004127P** x 1 **15,00 €**



Noir / Carte des vins **P.U.HT**  
**1004122** x 1 **15,00 €**

## Rio

Protège-menu A4 en PVC. Le protège-menu est livré avec 1 pochette transparente 4 vues format A4, maintenues grâce à un lacet élastique. Rajout de pochettes A4,4 vues : réf 1004062.



	Rouge <b>1004109</b>	x 1	<b>P.U.HT</b> <b>7,60 €</b>
	Orange <b>1004108</b>	x 1	<b>P.U.HT</b> <b>7,60 €</b>
	Vert <b>1004110</b>	x 1	<b>P.U.HT</b> <b>7,60 €</b>
	Violet <b>1004111</b>	x 1	<b>P.U.HT</b> <b>7,60 €</b>
	Noir <b>1004107</b>	x 1	<b>P.U.HT</b> <b>7,60 €</b>
	Noir / Carte des vins <b>1004105</b>	x 1	<b>P.U.HT</b> <b>7,60 €</b>

## 1<sup>er</sup> PRIX

### Basic

Protège-menus simili cuir. Le protège-menu est livré avec 10 pages A4 et il n'est pas possible d'en ajouter.



Noir / Porte addition **P.U.HT**  
L. 23 x l. 13 cm x 1 **5,00 €**  
**1003756P**

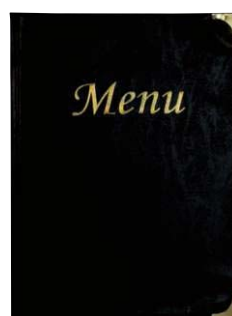

Noir **P.U.HT**  
L. 31 x l. 23 cm **1003751P** x 1 **6,00 €**



Noir / Carte des vins **P.U.HT**  
L. 31 x l. 23 cm x 1 **1003755P** **6,00 €**



## CHEVALETS DE TABLE

### Chevalet de table

En PVC socle bois.



Paquet de 3  
**62728** L. 18 x l. 12 cm x 1 **P.U.HT**  
**21,00 €**



### Chevalet socle bois

Ardoise amovible pour faciliter l'écriture et le nettoyage. Utilisation intérieur / extérieur. Écriture au feutre craie (non fourni).

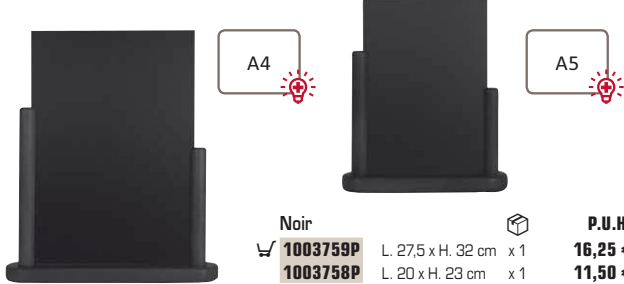

A4

A5

Noir  
✔ **1003759P** L. 27,5 x H. 32 cm x 1 **P.U.HT**  
**16,25 €**  
**1003758P** L. 20 x H. 23 cm x 1 **11,50 €**



### Porte visuel

Porte-visuels double face, en matière acrylique et totalement transparent.



**A 1008405P** E A4 - L. 21 x l. 29,7 cm x 6 **P.U.HT**  
**7,00 €**  
**B 1008406P** E A5 - L. 14,8 x l. 21 cm x 5 **5,00 €**  
**C 1008407P** E A6 - L. 10,5 x l. 14,8 cm x 5 **4,00 €**



## nouveau !

### Ardoise auto adhésive

À utiliser sur toutes surfaces. Écriture au feutre craie. Effaçable à l'eau.



Rouleau ardoise  
**1014069** l. 45 x l. 100 cm

**P.U.HT**  
x 1 **10,00 €**

### Ardoise



Etiquette ovale ardoise - Lot de 8  
**1014068P** L. 8,5 x l. 8,5 cm

**P.U.HT**  
x 1 **4,00 €**

## PEINTURE / FEUTRES CRAIE

### Peinture ardoise

Peinture acrylique à base d'eau à utiliser avec des feutres-craie ou des craies traditionnelles. Créez votre propre ardoise sur tout support : Métal, céramique, plastique ou bois (L'utilisation d'une base pour les surfaces non lisses est recommandée).



Noir - 250 ml  
**1011459P** Pour une surface de 5 m<sup>2</sup> x 1 **P.U.HT**  
**10,00 €**



### Feutre craie

Ces feutres craie à encre liquide sont munis d'un système de valve qui permet à la pointe de ne jamais s'assécher. L'encre est effaçable à l'aide d'un chiffon humide. Utilisation prévue pour : ardoise, vitrine, miroir, plastique, métal, verre et toutes les autres surfaces non poreuses. Pointe biseauté de 2-6 mm pour le modèle standard et rectangulaire de 7-15 mm pour le modèle large.



Lot de 4  
Jaune, vert, rouge, bleu

Pointe large 7 à 15 mm  
✔ **A 1004052P** Blanc x 1 **P.U.HT**  
**5,60 €**  
**B 1004055P** Lot de 4 x 1 **23,25 €**



Pointe standard 2 à 6 mm  
✔ **A 1004053P** Blanc x 1 **P.U.HT**  
**2,50 €**  
**B 1004057P** Lot de 4 x 1 **13,00 €**



### Feutre craie waterproof

Ne coulent pas, ne décolorient pas et s'utilisent sur toutes surfaces non poreuses. A nettoyer avec une éponge et le spray nettoyant Securit. Waterproof donc parfait pour une utilisation sur chevalets extérieurs même par temps de pluie.



Pointe standard 2 à 6 mm  
**1011455P** Paquet de 4 - Blanc x 1 **P.U.HT**  
**13,10 €**



### Spray nettoyant

Produit nettoyant spécial feutres craies waterproof.



Spray de 500 ml  
✔ **1011460P**

**P.U.HT**  
x 1 **7,50 €**



## Ardoise classique

SecurIT

Gamme d'ardoises rectangulaires à la fois modernes et fonctionnelles. Vernies de trois couches pour permettre un usage intérieur et extérieur. Ces ardoises sont en bois dur et sont résistantes aux rayures, aux UV et aux déformations dues à la chaleur. Deux petits crochets sont fournis pour accrocher les ardoises à l'aide d'une cordelette (non incluse).



Noir L. 80 x l. 60 cm  
1004005P

x 1 P.U.HT  
40,00 €

Teck  
L. 150 x l. 56 cm  
1004019

x 1 P.U.HT  
80,50 €



## 1<sup>er</sup> PRIX

### Ardoise Woody

SecurIT

Ardoise murale facile à utiliser : effaçable à l'eau et réutilisable. Surface ardoise plastique résistante aux rayures. Livrée avec un feutre craie.



Teck  
1004144P L. 60 x l. 40 cm  
1004146P L. 80 x l. 60 cm

x 1 P.U.HT  
16,00 €  
x 1 P.U.HT  
27,25 €



Noir  
1004143P L. 60 x l. 40 cm  
1004145P L. 80 x l. 60 cm

x 1 P.U.HT  
16,00 €  
x 1 P.U.HT  
27,25 €

## nouveau !

### Porte-affiche

SecurIT

En plastique. Double face, doté de 4 ventouses.



1014071P L. 27 x H. 36 cm

x 1 P.U.HT  
20,25 €

## Carnaval

BEQUET  
Le plus des professionnels

Chevalet 2 faces encadrement bois traité pour l'extérieur. Ardoise en forex noir 10 mm. 2 compas de maintien. Ligne très tendance. Aspect cérusé patiné. L. 67,5 x l. 110 x H. 115 cm.



Gris  
62110 x 1 P.U.HT  
265,00 €



Mastic  
65468 x 1 P.U.HT  
265,00 €

## 1<sup>er</sup> PRIX

### Sandwich

SecurIT

Les panneaux trottoir sandwich sont composés de deux ardoises de qualité supérieure reliées par une chaîne. Prévu pour un usage intérieur et extérieur grâce à une triple couche de vernis de protection. Panneaux en bois dur et résistants aux rayures, aux UV et aux déformations dues à la chaleur. Ecriture au feutre craie.



Acajou  
H. 135 x l. 75 cm  
1003779P x 1 P.U.HT  
135,00 €



Noir  
H. 120 x l. 68 cm  
1003783P x 1 P.U.HT  
106,00 €

## nouveau !

### Chevalet de trottoir

BEQUET  
Le plus des professionnels

En acier 2 faces. Ecriture au feutre craie. Produit très solide, peinture époxy, résistant aux intempéries.



Noir - L. 65 x l. 80 x  
H. 120 cm  
1013590 x 1 P.U.HT  
198,00 €

### Lampe LED

SecurIT

GARANTIE 1 an CE

Étanche. 230 V. Peut être branché sur Batterie SecurIT (optionnelle) pour s'affranchir du câble secteur.



S'accroche à tous les chevalets et tableaux.

L. 31 x l. 7,5 x  
H. 11 cm  
1014059 x 1 P.U.HT  
35,25 €





## Porte-menus LED classique



Porte-menus LED 4 pages. Dispose d'une vitre de sécurité et d'une plaque magnétique intérieure. Ce porte-menus Securit® s'utilise en intérieur ou extérieur et résiste aux intempéries. C'est un support idéal pour attirer les clients et présenter vos menus et promotions à l'entrée de votre restaurant. Peut être branché sur secteur ou utilisé avec les batteries Securit® (non incluses). Pied et socle vendus séparément.

## Premium

### Porte-menus LED multicolor



Porte-menus en inox brossé antirouille à affichage LED basse consommation avec des couleurs de très haute qualité. Dispose de 5 programmes, 16 couleurs et est livré avec une télécommande. Peut être posé au mur ou monté sur pied (vendu séparément). Il peut être branché sur secteur ou utilisé avec 2 packs de batterie Securit® (non inclus). Le socle (vendu séparément) est équipé de 2 roues pour une manutention aisée du produit. Prévu pour un usage intérieur et extérieur. Alimentation 230V.



Porte-menus		☐	P.U.HT
<b>1004094</b>	Modèle 4 pages	x 1	<b>449,00 €</b>
<b>1004093</b>	Modèle 6 pages	x 1	<b>599,00 €</b>
<b>Pied de porte-menus</b>			
<b>1004095</b>	H. 120 cm	x 1	<b>100,50 €</b>
<b>Socle</b>			
<b>1004096</b>	L. 46 x l. 40 x H. 7,8 cm	x 1	<b>99,50 €</b>
<b>Batterie LED</b>			
<b>1004092P</b>		x 2	<b>81,50 €</b>

### Porte-menus LED rotatif



Pied, socle et présentoir inclus. Présentoir tout en un, technologie LED à économie d'énergie. Résistant à tous types d'intempéries et verre de sécurité. Métal peint. Peut être utilisé hors secteur grâce à 2 batteries Securit® (vendues séparément). Alimentation 230 V.



Position verticale : H. 135 x L. 50 cm  
Position horizontale : H. 127 x L. 68 cm

<b>Porte-menus</b>			
<b>1006308</b>	Modèle 4 pages	x 1	<b>400,00 €</b>
<b>Batterie LED</b>			
<b>1004092P</b>		x 2	<b>81,50 €</b>



Modèle 4 pages		☐	P.U.HT
<b>1008409</b>	A - Acier	x 1	<b>301,00 €</b>
<b>1008412</b>	B - Teck	x 1	<b>199,00 €</b>
<b>1008413</b>	C - Wengé	x 1	<b>199,00 €</b>
<b>Pied et socle</b>			
<b>1008414</b>	H. 125 cm	x 1	<b>99,50 €</b>
<b>Batterie LED</b>			
<b>1004092P</b>		x 2	<b>81,50 €</b>



## Porte-menus Glass Star non éclairé



Porte-menu en bois de noyer sans éclairage. Dispose d'une plaque de verre pour protéger votre menu. Ce porte-menu Securit® s'utilise en intérieur ou extérieur et résiste aux intempéries. Support idéal pour présenter vos menus et promotions. Pied en option.



E - Pied H. 85 cm



	Bois de noyer	Bois de chêne
Nb de pages 1 x A4	A - 1008404 53,50 €	C - 1008469 53,50 €
Nb de pages 4 x A4	B - 1008403 109,00 €	D - 1008402 109,00 €
Pied + socle	E - 1008470 55,50 €	



## Vasque à bouteille

En inox.

INOX  
18/10



Poli-miroir

40666

Ø 42 cm

x 1

P.U.HT

161,00 €

1<sup>er</sup> PRIX

## Vasque à bouteille

En inox.



Poli-miroir

1001434P

Ø 34 x H. 21,2 cm

x 1

P.U.HT

52,00 €

## Rafraîchisseur

En inox double paroi.



1001366P

Ø 11,7 x H. 20 cm

x 1

P.U.HT

16,00 €

## Seau à champagne

En inox.



Poli-miroir

40660

Ø 19 x H. 20 cm

x 1

P.U.HT

54,50 €

nouveau !

## Porte-seau à champagne

En inox 18/8 brillant, pour les seaux à vin ou champagne standard (base 15 cm, haut 20 cm), intérieur support Ø 17,5 cm.



1013530

H. 73 cm

x 1

P.U.HT

99,50 €

## Seau à glaçons

En inox.



1001431P

Ø 12,5 x H. 12 cm

x 1

P.U.HT

26,75 €



Poli-miroir

1001432P

Ø 20,5 x H. 21 cm

x 1

P.U.HT

31,00 €

## Porte-seau à champagne

En inox.



1001428P

H. 73,5 cm

x 1

P.U.HT

85,50 €

1<sup>er</sup> PRIX

En inox.



Poli-miroir

42691

Ø 12 x H. 12 cm

x 12

P.U.HT

18,50 €

Pince à glaçons

1005080P

18 cm

x 1

P.U.HT

2,80 €



Poli-miroir

1001433P

Ø 21,5 x H. 21 cm

x 1

P.U.HT

21,50 €

## Porte seau à champagne

En inox. Ce porte-seau s'adapte à toutes les tables.



67641P

Ø 18,5 cm

x 1

P.U.HT

35,75 €





nouveau !

### Seau à glaçons

En plastique aspect métal brillant, avec pince inox et égouttoir, paroi intérieure spécialement isolante.



1013539 Ø 14 x H. 22 cm - 1,3 L x 1 P.U.HT 24,25 €

nouveau !

### Vasque à bouteilles

En plastique. Pour 3 bouteilles.



1014058P L. 35 x 25,5 x H. 26 cm - 8 L x 1 P.U.HT 20,75 €

### Seau à glaçons

En verre.



1002152P Ø 13,8 x H. 16,3 cm - 1,3 L x 3 P.U.HT 8,10 €

nouveau !

### Seau à bouteille

En acrylique transparent avec anse.



1014057P L. 20 x l. 19,5 x H. 25 cm - 3 L x 1 P.U.HT 10,80 €

### Seau à glaçons

En ABS. Avec couvercle.



58387P Ø 14 x H. 18 cm - 1,75 L x 1 P.U.HT 12,40 €

### Ice bag

En PVC. Seaux à bouteille Ice bag® réutilisable.



1001344P L. 11 x l. 11 x H. 25,5 cm x 6 P.U.HT 3,00 €

1<sup>er</sup> PRIX

### Seau à bouteille

En acrylique.



47357P H. 23 cm x 1 P.U.HT 12,40 €

### Rafrâchisseur isotherme

ABS transparent



65060P Ø 11,5 x H. 23 cm x 1 P.U.HT 16,75 €

### Rafrâchisseur isotherme

Polypropylène aspect métal satiné.



69119P Ø 12,5 x H. 22 cm x 1 P.U.HT 14,30 €

nouveau !

### Pelle à glace

En copolyester.



1013783P L. 11 x l. 14 x H. 15 cm x 1 P.U.HT 6,70 €



30 cl 1013784P L. 10 x l. 10 x H. 26,5 cm x 1 P.U.HT 4,70 €

## Cocktail Master

Réalisez, en un instant, un cocktail superbe et délicieux ! Il suffit de verser un à un les liquides dans Cocktail Master, du plus doux au moins dense, pour obtenir un savoureux cocktail à couches multicolores.

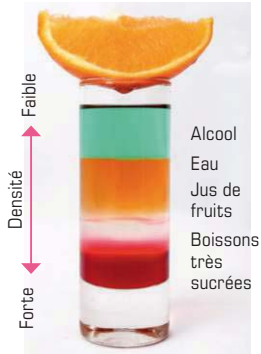

50408P L. 30 x l. 14 x H. 8 cm

P.U.HT  
x1 48,25 €

## Nécessaire à givrer

En ABS. 3 niveaux.



65133P Ø 15,5 x H. 7,3 cm

P.U.HT  
x1 38,50 €

nouveau !

## Bouteille verseuse

En copolyester. Bouteille de flair pour s'initier à la pratique du flair bartending. Plastique dur incassable et avec un bon grip.



0,75 L

1013773P  
1013772P

Cuivre  
Blanc

P.U.HT  
x1 18,75 €  
x1 12,70 €

## Dash bottle

En verre sodocalcique. Accessoire tendance pour la préparation des cocktails. Avec bouchon bec verseur bi-matière liège et inox.



Dash bottle

1013244

L. 5,7 x l. 5,7 x H. 13,5 cm  
10 cl

P.U.HT  
x1 5,50 €

## Shaker

En inox.



Shaker 2 pièces

67643P 90 cl  
36424 75 cl

P.U.HT  
x1 59,00 €  
x1 57,50 €



Shaker 3 pièces

62733 70 cl

P.U.HT  
x1 31,50 €



Shaker 2 pièces

1001369P 50 cl

P.U.HT  
x1 21,25 €

## Rialto

En verre sodocalcique. Idéal pour la préparation des cocktails devant être mélangés et non secoués. Le bec verseur a été étudié pour un versement sans éclaboussures.



1011767P 55 cl

P.U.HT  
x1 18,50 €

nouveau !

## Tapis de bar

En caoutchouc. Carreaux emboîtables entre eux par simple clips. Produit découpable pour obtenir la taille désirée.

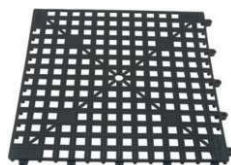

1013786P L. 33 x l. 33 x H. 1 cm

P.U.HT  
x1 4,90 €

## Passoire cocktail

En inox.



71176P Ø 14 cm

P.U.HT  
x1 11,50 €

nouveau !

## Passoire à cocktail conique

En inox.



1013776P Ø 9 cm

P.U.HT  
x1 3,50 €

## Passoire à cocktail ronde

En inox.



1013777P Ø 8,5 cm

P.U.HT  
x1 3,50 €

## Passoire à shaker

Passoire large sans pattes, avec cerclage complet.



1013778P Ø 9 cm

P.U.HT  
x1 11,50 €

## Passoire Julep

Accessoire principalement utilisée pour les cocktails et boissons préparées au verre à mélange.



1013779P Ø 71 cm

P.U.HT  
x1 3,50 €



# SPEED CUP

nouveau !

## Speed Cup

Adaptable sur tous les shakers Boston, cette speed cup ou «cheater tin» peut remplacer le verre à mélange pour la réalisation de vos cocktails.



Plombé, spécial Flair



Shaker 1 pièce  
**1013781P** 60 cl



x 1  
**P.U.HT**  
**5,60 €**

## Shaker plombé

Adaptable à tous les verres de bars à cocktails de type Mixing glass et Gibraltar ainsi que les speed cup. Autres couleurs disponibles. Nous consulter.



Plombé, spécial Flair



Shaker 1 pièce  
**1013782P** 80 cl



x 1  
**P.U.HT**  
**6,30 €**

## Boston

En inox et verre.



Shaker 2 pièces  
**1013790P** 80 + 50 cl



x 1  
**P.U.HT**  
**10,50 €**

nouveau !

## Pailles en verre SERAX

Pailles en verre idéales pour les smoothies et cocktails.



Boîte de 4

**1006501** L. 23 x Ø 0,9 cm  
**1007260** L. 23 x Ø 1,2 cm



x 12  
x 12

**P.U.HT**  
**7,80 €**  
**9,40 €**

## Cuillère Frida

En inox 18/0.



**49092P** L. 19,9 cm



x 12

**P.U.HT**  
**0,53 €**

## Cuillère à mélange

En inox 18/0.



**67642P** L. 32 cm



x 1

**P.U.HT**  
**5,30 €**



**67640P** L. 28 cm



x 1

**P.U.HT**  
**5,10 €**

## Broyeur à glaçons manuel

Lame en acier inox. Fixation par ventouse très puissante à vide d'air.

Ventouse puissante



**3629P** L. 11 x l. 11 x H. 24 cm



x 1

**P.U.HT**  
**25,00 €**

## Broyeur à glaçons

Corps en acier inoxydable et alliage d'aluminium alimentaire. Sécurité : arrêt du moteur à l'ouverture du tiroir ou de la goulotte d'alimentation. Livré avec 1 disque standard (Ø 11 cm).



GARANTIE 2 ans

CE  
Made in France



**N9**

Alimentation	230 V
Puissance	600 W
Rendement	100 kg/ h de neige ou glace pilée
Dimensions (L x P x H)	25 x 42 x 35 cm
Poids	14 kg
Référence	<b>4566</b>
P.U.HT	<b>642,00 €</b>
	x 1

nouveau !

## Cuillère mesure double

En copolyester.



**1013775P** 0,5 et 1,5 cl



x 1

**P.U.HT**  
**3,50 €**

## Pince à glaçons

En copolyester.



**1013774P** L. 20 cm



x 1

**P.U.HT**  
**5,50 €**

## Bac à glaçons

En caoutchouc.



**44125** 40 cubes



x 4

**P.U.HT**  
**13,80 €**

## Bouteille verseuse

En polypropylène blanc opaque. Bec verseur en plastique transparent. Hauteur réservoir : 17 cm.



Bouteille avec couvercle, goulot et bec

**1001462P**  
**1001466P**

Ø 9 x H. 33 cm - 1 L  
Couvercle de rechange



x 1

**P.U.HT**  
**9,50 €**



x 1

**1,30 €**



**1001465P** Bec verseur Orange  
**1001464P** Bec verseur Vert  
**1001463P** Bec verseur Rouge



x 1

**P.U.HT**  
**2,60 €**



x 1

**2,60 €**



x 1

**2,60 €**



nouveau !

## Tapis de bar

En polypropylène.



1013771P L. 300 x l. 60 cm



x 1 P.U.HT 17,00 €

## Porte-accessoires

En plastique résistant.



65066P L. 24 x l. 15 x H. 10,5 cm



x 1 P.U.HT 30,25 €

nouveau !

## Porte-addition

1 plateau inox poli brillant  
+ 1 pochette cuir aimantée.

1013532P L. 20 x l. 16 cm



x 1 P.U.HT 24,75 €

## Tapis de bar

Tapis de bar rectangulaire en plastique souple.



63508P L. 45 x l. 30,2 cm - Noir



x 1 P.U.HT 11,20 €



65065P L. 59 x l. 8 cm - Marron



x 1 P.U.HT 23,00 €

nouveau !

## Bac à ingrédients

En ABS et copolyester. Avec 6 compartiments de 50 cl et couvercle à charnière.



1013788P L. 45 x l. 14 x H. 16 cm



x 1 P.U.HT 25,50 €

## Coupelle monnaie

Soucoupe ø 11 cm.



Avec clapet



52782P

Noir



x 20 P.U.HT 1,60 €

52781

Vert



x 20 P.U.HT 1,60 €

52780

Bordeaux



x 20 P.U.HT 1,60 €

En ABS.



Avec clip

1013533P L. 20 x l. 12 cm



x 1 P.U.HT 1,70 €

Couverture en cuir écologique, support en bois et une fermeture par le biais d'un élastique.



1014070P L. 17,9 x l. 10 cm



x 1 P.U.HT 12,60 €

nouveau !

## Support bois

En hêtre. Avec 10 empreintes pour shooter.  
(vendu sans verres).

Planche

1013645 L. 100 x l. 10 x H. 2 cm



x 1 P.U.HT 35,25 €

En inox.



Avec pince

71177P L. 21,5 x l. 12,4 cm



x 1 P.U.HT 5,60 €

nouveau !

## Mallette de barmen



Contient : 4 verseurs pro, 1 passoire 4 pattes, 1 cuillère à mélange, 1 ouvre bouteille, 1 shaker 80 cl, 1 mesureur Pourfect Easy, 1 passoire ronde inox, 1 presse citron jaune et 1 pilon. Dotée d'une sangle d'épaule ajustable.



**1013789P** L. 14 x l. 16 x H. 27 cm x 1 **P.U.HT 84,50 €**

nouveau !

## Coupe-fruits



En ABS. Appareil de découpe manuelle de fruits en 6 quartiers.



**1013787P** L. 11 x l. 18 x H. 19 cm x 1 **P.U.HT 41,00 €**

nouveau !

## Presse-agrumes manuel



En nylon et fibre de verre.



**1013780P** Ø 10 x L. 26 cm x 1 **P.U.HT 10,90 €**

## Planche à découper



Avec rigole, en polyéthylène noir haute densité, avec 6 pieds en caoutchouc.



**1006795P** L. 53 x l. 32,5 cm x 1 **P.U.HT 44,50 €**

## Couteau à tomates



Indispensable en cuisine.



**48366P** E. Lame 10 cm x 1 **P.U.HT 2,60 €**

## Canneleur double



En inox. Manche ABS. Pour droitier.



**45143** L. 10 cm x 12 **P.U.HT 6,40 €**

## Canneleur décozesteur



En inox. Manche polypropylène. Pour droitier.



**782** L. 10 cm x 12 **P.U.HT 7,50 €**

## Râpe à muscade

En inox. Avec réservoir.



**62037P** L. 17,8 cm x 1 **P.U.HT 4,20 €**

## Presse agrumes



En inox.



**1005083P** x 1 **P.U.HT 20,50 €**

## Porte-cuillères

En inox.



Porte cuillère **61458P** Ø 8,5 x H. 10 cm x 1 **P.U.HT 12,10 €**

Cuillère à moka **69202P** Boîte de 120 x 1 **P.U.HT 32,50 €**

## Sucrier boule

En Inox.



**67664P** Ø 14 x H. 13 cm x 1 **P.U.HT 21,75 €**

nouveau !

## Pilon XL



En polypropylène. 2 embouts utilisables : grillagé d'un côté et plat de l'autre.



**1013769P** L. 29 x Ø 3,9 cm x 1 **P.U.HT 7,90 €**

## Pilon

En plastique noir.



**1001467P** L. 21 x Ø 2,5 cm x 1 **P.U.HT 6,90 €**

## DOSEURS DISTRIBUTEURS

### Doseur distributeur Atlan

GARANTIE **3** ans

Mécanisme en inox. Cuve en verre. Centralisateur en laiton chromé (2 et 6 cl) ou en lexan (3, 4 et 5 cl). Le pare-gouttes breveté garantit une étanchéité parfaite. Fonctionnement garanti 3 ans (hors cuve en verre et bouchon).



<b>Queue ronde</b>				
<b>5070P</b>	2 cl	x 1	<b>63,50 €</b>	
<b>5073</b>	4 cl	x 1	<b>63,50 €</b>	
<b>5074</b>	5 cl	x 1	<b>63,50 €</b>	
<b>Bouchon</b>				
<b>52436P</b>	Liège normal	x 12	<b>0,70 €</b>	
<b>Support d'étagère</b>				
<b>39265</b>		x 1	<b>39,00 €</b>	

### Doseur à alcool

À queue plate. Pour tous alcools et anis. Cuve verre. Habillage métal.



<b>44089</b>	1 cl	x 6	<b>47,50 €</b>	
<b>44091</b>	2 cl	x 6	<b>47,50 €</b>	
<b>52432*</b>	3 cl	x 6	<b>47,50 €</b>	
<b>52433*</b>	4 cl	x 6	<b>47,50 €</b>	
<b>52434</b>	5 cl	x 6	<b>47,50 €</b>	

\*sauf anis.

### Support doseur

Patte métal. Existe en modèles rampe et rotatif pour plusieurs bouteilles.



<b>Bouchon en liège</b>				
<b>44115</b>	Paquet de 100	x 1	<b>70,50 €</b>	
<b>Kit 6 joints</b>				
<b>44118</b>	Lot de 10	x 10	<b>2,00 €</b>	
<b>Support pour bouteille</b>				
<b>44103</b>	De 0,7 à 1 L	x 6	<b>19,50 €</b>	
<b>52517</b>	Magnum	x 1	<b>25,75 €</b>	

## MESURES

### Mesure étain



<b>49381P</b>	20 cl	x 1	<b>52,50 €</b>	
<b>48718P</b>	10 cl	x 1	<b>38,50 €</b>	
<b>48677P</b>	5 cl	x 1	<b>33,00 €</b>	
<b>48067P</b>	2 cl	x 1	<b>25,25 €</b>	
<b>48675P</b>	1 cl	x 1	<b>20,50 €</b>	

### Mesure inox



<b>1001423P</b>	H. 7,5 cm - 2/4 cl	x 1	<b>18,00 €</b>
-----------------	--------------------	-----	----------------

## DOSEURS

### Doseur Bottle Pilot

Doseur à dose précise. Verse en série.



<b>68783P</b>	2 cl	x 1	<b>11,00 €</b>	
<b>68784P</b>	4 cl	x 1	<b>11,00 €</b>	
<b>68785P</b>	5 cl	x 1	<b>11,00 €</b>	

### Doseur à billes

En plastique.



<b>1002211P</b>	2 cl	x 1	<b>5,90 €</b>	
<b>1002212P</b>	3 cl	x 1	<b>5,90 €</b>	
<b>1002213P</b>	4 cl	x 1	<b>5,90 €</b>	
<b>1002214P</b>	5 cl	x 1	<b>5,90 €</b>	

### Doseur boule Pyrex



<b>40573</b>	1 cl	x 50	<b>3,70 €</b>	
<b>40574</b>	1,5 cl	x 50	<b>3,70 €</b>	
<b>40575</b>	2 cl	x 50	<b>3,70 €</b>	
<b>40577</b>	3 cl	x 50	<b>4,90 €</b>	
<b>40578</b>	4 cl	x 50	<b>5,90 €</b>	
<b>40579</b>	5 cl	x 50	<b>5,10 €</b>	

## BECS VERSEURS / ACCESSOIRES

### Bec verseur en métal



<b>Bec en laiton</b>				
<b>31055</b>		x 12	<b>2,60 €</b>	
<b>Bouchon liège</b>				
<b>44117</b>	Pour boule Ø 11 cm	x 50	<b>0,81 €</b>	
<b>49081</b>	Pour boule Ø 13 cm	x 200	<b>0,60 €</b>	
<b>52553</b>	Magnum (lot de 10)	x 1	<b>30,75 €</b>	

nouveau !

### Bec verseur

The Bars INOX 18/10

Bec verseur double jet. Caoutchouc renforcé. Débit calibré au micron.



<b>1013785P</b>		x 12	<b>1,90 €</b>
-----------------	--	------	---------------

### Bec verseur

En inox et silicone.



<b>A</b>	Inox et silicone	x 4	<b>7,50 €</b>	
<b>B</b>		x 1	<b>2,70 €</b>	

nouveau !

### Bec verseur

En caoutchouc naturel. Adaptable sur tous types de bouteilles.



<b>1013768P</b>		x 12	<b>0,33 €</b>
-----------------	--	------	---------------

### Pompe à sirop pour bouteille

Par pression.



<b>5104</b>		x 10	<b>5,80 €</b>
-------------	--	------	---------------

## Ceinture limonadier & lитеau

Ceinture limonadier : 65% polyester / 35% coton.  
Lитеau 100% coton.



Liteau blanc  
6029P L. 77 x l. 55 cm x 30 **P.U.HT**  
**3,30 €**



Ceinture limonadier noire  
65501 Taille 36/38 x 1 **P.U.HT**  
**43,25 €**  
65502 Taille 44/46 x 1 **43,25 €**  
65504 Taille 52/54 x 1 **43,25 €**

## Tablier sommelier

65 % polyester, 35 % coton. Tour de cou réglable.  
Poche décapsuleur arrondie. 2 poches devant.



Noir  
41533 L. 110 cm x 1 **P.U.HT**  
**41,50 €**

## Bouchon à champagne

Chromé. Parfaite étanchéité.



1003276P Ø 3.5 x H.5.6 cm x 1 **P.U.HT**  
**5,30 €**

## Feuille anti-goutte

En PET aluminium. S'adapte à toutes les bouteilles.  
Lavable et réutilisable. Évite les gouttes sur vos nappes.



1001269P Boîte de 10 x 1 **P.U.HT**  
**17,50 €**

## Verseur à vin

Pour présenter vos bouteilles avec élégance. Diamètre de fil inox 6 mm.



1001549P L. 23 x l. 5,5 x H.21,5 cm x 1 **P.U.HT**  
**10,00 €**

## Dessous de bouteille

En inox.



Lot de 2  
53510 Lot de 2 Ø 8,5 cm x 1 **P.U.HT**  
**9,20 €**



67637P Ø 14 cm x 1 **P.U.HT**  
**4,00 €**

## Sac bouteille

En papier brun. Permet le transport de bouteilles. Parfait pour proposer une solution doggy bag aux restaurateurs.



Paquet de 250  
1009024P L. 14 x l. 9 x H. 36 cm x 1 **P.U.HT**  
**80,50 €**

## Presse-fruits sur pied professionnel

En inox (contact alimentaire pour le jus), aluminium et chromé. Hauteur maxi pour un verre (à mettre sous l'appareil) : 14 cm.



Poids 4,8 kg  
52764 L. 19 x H. 60,5 x P. 22 cm x 1 **P.U.HT**  
**99,50 €**

## Porte agrumes

Corbeille à fruits en fil d'acier inoxydable, empilable.



1001553P Ø 21 x H. 20 cm x 1 **P.U.HT**  
**38,50 €**

## Corbeille à fruits

Corbeille à fruits verticale en fil métal chromé.



1011077P L. 37 x l. 16 x H. 46 cm x 1 **P.U.HT**  
**33,50 €**



## CONSERVATION DES VINS

### Wibox



La Wibox est une cave réfrigérée permettant le maintien en température des bouteilles à leur meilleure température de conservation, tout en offrant une vue directe sur les étiquettes. Convient à des bouteilles de Ø 8,5 cm max. Contrôle de la température entre 8°C et 18°C avec une température ambiante maximale de 30°C. Eclairage de chaque bouteille par LED. Alimentation 230V - 600W.



**2 bouteilles**  
**1008290** L. 27 x l. 26 x H. 27 cm x 1 **P.U.HT 321,00 €**



**4 bouteilles**  
**1008291** L. 48 x l. 26 x H. 27 cm x 1 **P.U.HT 355,00 €**

### Wikeeps



Kit complet de service et de conservation des vins tranquilles. Respecte la qualité du vin jusqu'à 20 jours après ouverture. Contient : 1 pistolet distributeur, 1 coupole centrale Elite pour vins tranquilles, 1 bec verseur, 1 filtre, 1 lot de 3 bouchons conserveurs (et 2 lots de recharge). Vendu sans cartouche.



**Set complet**  
**1008288P** L. 23 x l. 4 x H. 42 cm x 1 **P.U.HT 138,00 €**

Cartouches "Balance" tous vins (Argon / CO2). Les cartouches Wikeeps sont fabriquées dans l'Union Européenne et contiennent du gaz œnologique. Ce gaz, de qualité alimentaire, est issu de l'air. 1 cartouche = service de 3 bouteilles minimum. Jusqu'à 20 jours de conservation des qualités organoleptiques du vin.



**Cartouche Balance**  
**1008289** Boîte de 10 x 3 **P.U.HT 35,25 €**

### Conservateur Epivac Duo



Pompe à double fonction permettant de prolonger la vie d'une bouteille ouverte :

- Fonction vin : elle retire l'air de la bouteille ce qui permet de limiter l'oxydation du vin. Une bouteille entamée peut ainsi être conservée entre 2 et 8 jours selon l'âge du vin (attention: ne pas utiliser pour les vins pétillants).

- Fonction Champagne: elle insuffle de l'air dans la bouteille ce qui permet d'éviter l'évaporation du gaz carbonique et de conserver au champagne son pétillant pendant plusieurs jours.

Contient deux bouchons à vins et un à champagne.

Conserve vin et champagne



**Epivac Duo**  
**69737P** A - l. 8 x H. 12 cm x 1 **P.U.HT 24,00 €**



**Bouchon de recharge**  
**70274P** B - Vin (paquet de 4) x 1 **P.U.HT 9,60 €**  
**70273P** C - Champagne x 1 **P.U.HT 9,60 €**

## TIRE-BOUCHONS

### Tire-bouchon de comptoir

En métal chromé. Produit destiné à un usage professionnel intense. Levier de 13 cm.



**69362P** L. 53 x l. 17 x H. 85 cm x 1 **P.U.HT 48,25 €**

### Limonadier

En inox. Manche en plastique noir.



**44129P** L. 14 cm x 1 **P.U.HT 5,40 €**

### Tire-bouchon double détente



En inox. 3 fonctions : décapsuleur, tire-bouchon double détente et couteau.



**1006583P** L. 12,5 cm x 1 **P.U.HT 4,90 €**

### Tire-bouchon

Acier chromé. A 2 leviers.



**2524P** x 1 **P.U.HT 7,70 €**

nouveau !

### Décapsuleur

En inox.



**1013770P** L. 18,5 cm x 1 **P.U.HT 4,60 €**

### Décapsuleur

En acier nickélé.



**44131P** L. 10,5 cm x 1 **P.U.HT 1,30 €**





## Camtread antidérapant

Plateau à usage ultra-intensif en polyester renforcé de fibre de verre et recouvert d'une surface en caoutchouc antidérapante moulée dans la masse. Personnalisable.



<b>Rond - Noir</b>				
<b>1014083P</b>	Ø 45 cm	x 1	<b>P.U.HT</b>	<b>22,25 €</b>
<b>51532</b>	Ø 41 cm	x 12		<b>18,50 €</b>
<b>1014082P</b>	Ø 35,5 cm	x 1		<b>14,30 €</b>
<b>Ovale - Noir</b>				
<b>55106</b>	L. 73,5 x l. 60 cm	x 6	<b>P.U.HT</b>	<b>62,50 €</b>
<b>51438P</b>	L. 68,5 x l. 56 cm	x 1		<b>55,00 €</b>

## Limo antidérapant

En polypropylène.



<b>Rond - Prune</b>				
<b>1004321P</b>	Ø 45 cm	x 1	<b>P.U.HT</b>	<b>15,00 €</b>

Accroche sans coller et sans retenir la poussière.  
 Poids : tient parfaitement dans la main sans être trop lourd.  
 Lavable : résiste aux taches et passe au lave-vaisselle.  
 Monobloc : l'antidérapant ne peut pas se décoller.  
 Rigidité : ne se plie pas, ne se tord pas.  
 Incassable : il tombe, il rebondit !



## 1er PRIX

### Antidérapant

En polypropylène.



<b>Noir</b>				
<b>62691P</b>	Ø 35,5 cm	x 1	<b>P.U.HT</b>	<b>8,90 €</b>
<b>62692P</b>	Ø 40,5 cm	x 1		<b>13,20 €</b>

## Pose plateau bois

Pliant et résistant.



<b>A</b>	<b>1007064P</b>	L. 45 x l. 41 x H. 96 cm	x 1	<b>P.U.HT</b>	<b>71,50 €</b>
		Naturel			
<b>B</b>	<b>1008159</b>	58,42 x H. 89 cm	x 1	<b>P.U.HT</b>	<b>76,00 €</b>
		Noir			

## Plateau sans anse

En inox.



<b>1005077P</b>	L. 45 x l. 35 cm	x 1	<b>P.U.HT</b>	<b>46,00 €</b>
<b>1005078P</b>	L. 40 x l. 32 cm	x 1		<b>41,25 €</b>
<b>1005079P</b>	L. 35 x l. 27,2 cm	x 1		<b>35,50 €</b>

## Plateau

En inox.



<b>1005082P</b>	L. 32 x l. 26,5 cm	x 1	<b>P.U.HT</b>	<b>44,00 €</b>
<b>1005081P</b>	L. 25,8 x l. 20,2 cm	x 1		<b>28,50 €</b>

## Limonadier

En inox.



<b>1001427P</b>	Ø 40 cm	x 1	<b>P.U.HT</b>	<b>30,25 €</b>
-----------------	---------	-----	---------------	----------------



<b>53235</b>	Ø 40 cm	x 1	<b>P.U.HT</b>	<b>11,50 €</b>
--------------	---------	-----	---------------	----------------





## Room service bois

En bambou.



**1005751** L. 25 x l. 25 x H. 7 cm

**P.U.HT**  
x2 **24,00 €**

**1005752** L. 40 x l. 40 x H. 7 cm

**P.U.HT**  
x2 **42,25 €**

**1005608** L. 60 x l. 40 x H. 7 cm

**P.U.HT**  
x2 **52,00 €**



## Room service mélamine

Plateau mélamine angle droit. Finition brillante.  
Imputrescible : ne s'ébrèche pas, ne s'écaille pas.



**Cerise**  
**68760** L. 52 x l. 35 cm

**P.U.HT**  
x4 **35,50 €**

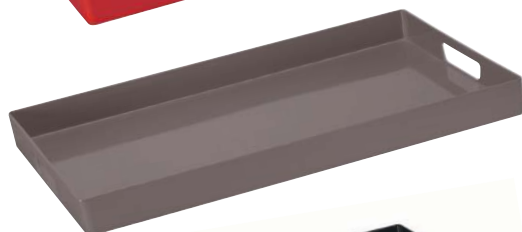

**Brun**  
**68761** L. 52 x l. 35 cm

**P.U.HT**  
x4 **35,50 €**

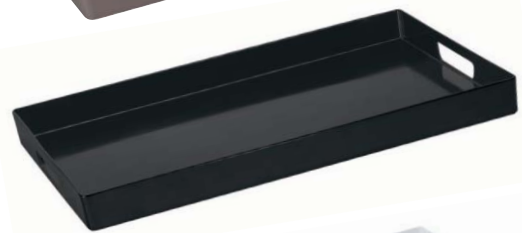

**Noir**  
**68759P** L. 52 x l. 35 cm

**P.U.HT**  
x4 **35,50 €**

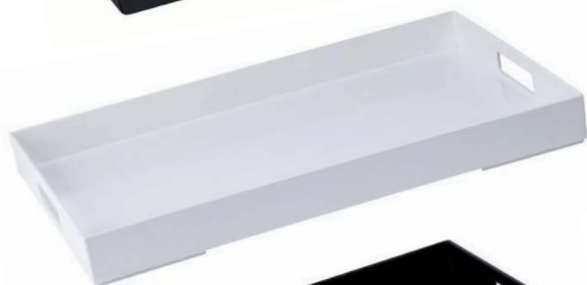

**Blanc**  
**1004322** L. 60 x l. 40 cm

**P.U.HT**  
x4 **50,50 €**



**Noir**  
**1004323P** L. 60 x l. 40 cm

**P.U.HT**  
x4 **50,50 €**

nouveau !



Surface grainée pour un effet naturel.



## Madeira



Avec plusieurs choix de motifs bois, il est facile de les assortir à votre décoration. La surface des plateaux est grainée sur les deux côtés. Ces plateaux offrent une excellente résistance aux produits chimiques, aux tâches et aux rayures. Fabriqué en matériau stratifié résistant. Passage au lave-vaisselle – 1 lavage par jour. Empilable pour un stockage aisé. Conforme NSF.



Chêne clair  
L. 24 x l. 35 cm  
**1014080P**



x 24

P.U.HT

**5,50 €**



Chêne foncé  
L. 24 x l. 35 cm  
**1014081**



x 24

P.U.HT

**5,50 €**

## Platex mat



Plateau stratifié mélaminé, âme placage bois. Adapté aux utilisations régulières mais non intensives. Finition mat, très moderne.



Bords droits



Bois ébène



L. 40 x l. 30 cm  
**1001229**



x 20

P.U.HT

**16,25 €**

## Platex



L'excellence du stratifié : l'âme en placage bois solidifie le plateau. Résistance optimale contre les chocs, les tâches, les micro-rayures et la chaleur du lave-vaisselle. Bord détourné arrondi, surface ultra-résistante, décor recto / verso identique et inaltérable.



L. 32,5 x l. 26,5 cm    L. 37 x l. 28 cm    L. 46 x l. 36 cm    L. 53 x l. 32,5 cm

<b>Grenade</b>	<b>65691</b>	<b>65694</b>	<b>65692</b>	<b>65693</b>
<b>Noisette</b>	<b>65699</b>	<b>65702</b>	<b>65700</b>	<b>65701</b>
<b>Anis</b>	<b>65703</b>	<b>65706</b>	<b>65704</b>	<b>65705</b>
	x 20	x 20	x 20	x 20
P.U.HT	<b>11,00 €</b>	<b>11,70 €</b>	<b>15,00 €</b>	<b>15,75 €</b>

## Capri



Plateau stratifié mélaminé. Surface scellée par une double couche de mélamine haute pression afin de permettre les lavages fréquents et une excellente résistance aux produits chimiques et tâches. Bonne résistance aux éraflures, chocs et à la casse. Lavage intensif jusqu'à 3 fois par jour. Personnalisable.

Noyer



L. 28 x l. 20 cm    L. 38 x l. 27 cm    L. 46 x l. 36 cm    L. 53 x l. 32,5 cm

**55095P**    **44279P**    **3271P**    **60712P**



x 24    x 24    x 24    x 24

P.U.HT

**3,30 €**

**5,60 €**

**7,00 €**

**8,30 €**

Lavage intensif



# PLATEX

1<sup>er</sup> Fabricant Français de Plateaux



## Plateau Poly-Styl ULTIM<sup>®</sup>,

Nouveauté 2018, plateau polyester décoré sur 90% de sa surface, forme très contemporaine, profil bas. Plateau destiné aux professionnels qui veulent un plateau résistant au design soigné. Fabrication Française.



**Polyester :**  
Très bonne rigidité  
Résistance aux lavages intensifs



## Poly-Styl Ultim

**PLATEX**  
1<sup>er</sup> Fabricant Français de Plateaux

Plateau en polyester décor bois naturel. Ceinture périphérique fine et basse permettant d'optimiser la surface utile. Bossage de séchage.



	L. 46 x l. 36 cm	L. 46 x l. 36 cm
Blanc / sequoia	1011773	Noir / cèdre
	x 20	x 20
P.U.HT	19,75 €	23,75 €

## Poly STR

**PLATEX**  
1<sup>er</sup> Fabricant Français de Plateaux

Plateau en polyester et fibre de verre haute densité à nattage continu et répartition homogène.

Plateau teinté et renforcé dans la masse, mono matière. Résiste à 150°C. Garanti 10 ans contre la casse.

Label NF plateau libre-service (Afnor T54-801).

ISO 178 (résistance à la flexion), ISO 179 (résistance aux chocs).

Système exclusif de bossages dits 3 en 1, les renforts des angles font également fonction de guide d'empilage et de bossages de séchage.

Bordure ultra-renforcée incassable.

Apte au contact alimentaire.

Dessous parfaitement plat, anti encrassement.

Garanti lave-vaisselle.



	L. 46 x l. 36 cm	L. 53 x l. 32,5 cm
Blanc	48047 E	40721 E
Granit Gris	48049P E	52425 E
Granit Bleu		52424 E
	x 20	x 100
P.U.HT	17,75 €	18,25 €

## Poly STR Profil mat

**PLATEX**  
1<sup>er</sup> Fabricant Français de Plateaux

Des couleurs tendances pour ce Poly STR Profil au revêtement grainé-mat. Conçu pour les collectivités ayant un usage intensif de leurs plateaux. Grâce à ses bords aplatis, il apporte plus de confort à l'utilisateur et optimise la surface utile.

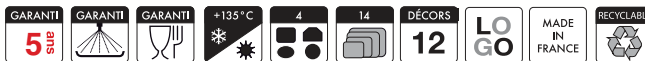

	L. 46 x l. 36 cm
Acier	1011752
Blanc	1001242
Noir	1001243
	x 20
P.U.HT	21,00 €

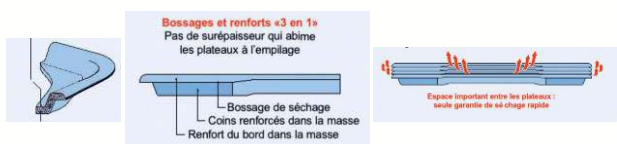



Usage intensif.  
Surface utile inégalee.



## Polyester Oxygen+

Plateau conçu pour les collectivités ayant un usage intensif de leurs plateaux. Ultra-plat, l'Oxygen+ est un plateau particulièrement adapté aux cafétérias qui souhaitent pouvoir offrir sur un même plateau (46 x 36 cm), plus de surface utile et un confort inégalé pour l'utilisateur. De plus, ce plateau a été dessiné pour apporter de la modernité avec des courbes jamais vues sur des plateaux de self.

L. 46 x l. 36 cm

Gris Béton	1004317P E
Vert Anis	1004318P E
Blanc	1004316P E
	20
<b>P.U.HT</b>	<b>15,25 €</b>



Le rebord et les angles plus bas augmentent la surface utile du plateau et le confort de l'utilisateur



## Polyester Versa Tray Century Fun

Plateau polyester à usage ultra intensif.

La gamme Century Fun vous offre un choix de couleurs tendances sur le fond d'un plateau blanc. Possibilité de personnaliser avec la couleur pantone de votre choix.

L. 46 x l. 36 cm

Bordeaux	1001284
Gris perle	1001285
Noir splash	1014076
Cassis splash	1014077
	x 12
<b>P.U.HT</b>	<b>13,90 €</b>



nouveau !





## Polyester Versa Tray

Usage ultra intensif, répondant à l'ensemble des critères et normes techniques de résistance aux chocs, aux taches, à l'abrasion, aux produits chimiques, et au contact alimentaire demandés par les collectivités. Bords et angles renforcés incassables, plots d'empilage permettant un séchage rapide, une libre circulation d'air et un parfait empilage. Passage au lave-vaisselle aussi fréquent que nécessaire. Garantie 5 ans contre la casse. Personnalisable.

L. 46 x l. 36 cm

L. 46 x l. 36 cm Century

Terrazzo	65423	65451
	x 12	x 12
<b>P.U.HT</b>	<b>11,50 €</b>	<b>11,50 €</b>
L. 46 x l. 36 cm		L. 46 x l. 36 cm
Noir	1014078P	1014079P
	x 12	x 12
<b>P.U.HT</b>	<b>12,00 €</b>	<b>12,00 €</b>



10 couleurs et 8 tailles disponibles  
Nous consulter



\*Century : le rebord et les angles plus bas augmentent la surface utile du plateau et le confort de l'utilisateur.

Usage régulier  
Surface utile inégale



## Polyester Oxygen



Plateau spécialement conçu pour les collectivités ayant un usage régulier (1 lavage / jour) de leurs plateaux. Le plateau Oxygen est garanti 5 ans contre la casse. Ultra-plat, l'Oxygen est particulièrement adapté aux cafétérias qui souhaitent pouvoir offrir sur un plateau (46 x 36 cm) plus de surface utile. De plus, ce plateau a été dessiné pour apporter de la modernité avec des courbes jamais vues sur des plateaux de self.

L. 46 x l. 36 cm	
Gris Marbré	1004319P E
	x 20
P.U.HT	10,20 €

## 1<sup>er</sup> PRIX

Usage modéré



## Polyester Eco

Plateau polyester à usage modéré. Excellent rapport qualité prix pour une utilisation nécessitant jusqu'à 2 lavages jour. Bords et angles renforcés, plats d'empilage permettant un séchage rapide, une libre circulation d'air et un parfait empilage. Garantie lave-vaisselle.

	L. 32,5 x l. 26,5 cm	L. 53 x l. 32,5 cm	L. 46 x l. 36 cm
Gris	1001362P E	1001363P E	1001361P E
	x 1	x 12	x 12
P.U.HT	4,80 €	6,70 €	6,20 €



Avantages du polypropylène :  
Incassable - Léger



Chariot  
cafétéria  
voir page 344

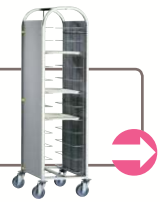

## Polypropylène Fast Food



Légers et pratiquement incassables, ces plateaux offrent une bonne rigidité, des bossages de séchage, une finition grainée antiglisse, et une compatibilité lave-vaisselle (1 lavage par jour à 80°C).

	L. 34,5 x l. 26,5 cm	L. 46 x l. 36 cm
Rouge	55152 E	55138 E
Jaune	65486 E	65483 E
Gris perle	65488 E	65484P E
Bleu marine	55157 E	55144 E
Brun	55153P E	55140 E
Vert	55155 E	55142 E
Groseille	65487P E	65485 E
	x 24	x 12
P.U.HT	2,40 €	3,90 €



## UN DESIGN ALLIANT INNOVATION ET ELEGANCE



### VIENNOISERIES

Le système Flow permet une multitude de mises en place alliant créativité et flexibilité, et est constituée de différents matériaux et finitions.



### PAINS

La gamme Flow offre des possibilités d'agencement uniques, basées sur le format gastroNorm et pouvant convenir à tous types de présentations et d'événements.



### CÉRÉALES

La nouvelle gamme Tilt est un système de buffet flexible alliant de nombreux supports, présentoirs et bols pour tout type d'aliments.



Craster propose des produits au design à la fois beau et intelligent, permettant aux hôtels et restaurants haut de gamme du monde entier de promouvoir leur image. Élégante et fonctionnelle, la collection Craster convient à la fois aux ambiances traditionnelles et modernes, offrant une nouvelle dynamique de présentation modulable et évolutive.



### FRUITS

La gamme 'Restaurants' propose notamment des produits de présentations gigognes de différentes tailles permettant une grande variété de présentations tout en facilitant le rangement.

### FROID

La solution Froid se compose d'un insert isolant, d'un accumulateur de froid et d'une planche d'ardoise format 1.2. Ce système se présente dans toutes les finitions Flow mais offre également des présentoirs en verre.



### CHAUD

La solution Chaud accompagnant la gamme Flow, se compose d'une plaque chauffante électrique chauffant jusqu'à 120°C. Ce système peut se présenter en chêne ou en noyer et peut être rehaussé selon vos besoins.

## Olive

Planche de service en bois d'olivier. Ne pas laver à l'eau chaude, ni immerger.



**1008257P** L. 30 x l. 20,5 cm

x 1 **P.U.HT**  
**46,25 €**



**1008227P** L. 44 x l. 20 cm

x 1 **P.U.HT**  
**64,50 €**



**1008226P** L. 25 x l. 16 cm

x 1 **P.U.HT**  
**30,25 €**

## Planche bois sur pieds



**1006001P** L. 50 x l. 20 x H. 8 cm

x 1 **P.U.HT**  
**29,50 €**

## Oak

Plateau mélamine imitation chêne, pour vos recettes authentiques. Avec poignée de 12 cm. Résiste à la casse. Léger.



**1008260** Ø 30 cm

x 6 **P.U.HT**  
**21,25 €**



**1008259P** L. 40 x l. 20 cm

x 1 **P.U.HT**  
**26,25 €**



**1008258** L. 48 x l. 20 cm

x 6 **P.U.HT**  
**32,25 €**

## Planche à fromage et tapas

En bois d'acacia.  
Ne passe pas au lave-vaisselle.



**1007491** Ø 20 cm

x 8 **P.U.HT**  
**8,90 €**



**1007492** L. 25 x l. 15 cm

x 8 **P.U.HT**  
**8,90 €**

**Planche bambou**  
Ne passe pas au lave-vaisselle.



**1006618P** L. 40 x l. 23 cm

x 1 **P.U.HT**  
**12,70 €**

nouveau !



**Planche bois**

Planche en bambou. Ne passe pas au lave vaisselle.



**1013190** L. 45 x l. 32 x H. 2 cm

x 3 **P.U.HT**  
**15,00 €**

PLANCHES



**1006619P** L. 30 x l. 23 cm

x 1 **P.U.HT**  
**10,20 €**

**Planche bois**

Hêtre massif. Ne passe pas au lave vaisselle.



A

**Planche en bois de hêtre**

Ne passe pas au lave-vaisselle.



**1002163P** L. 30 x l. 22 cm

x 1 **P.U.HT**  
**9,80 €**



B

A	<b>737</b>	L. 50 x l. 35 x H. 4,5 cm	x 1	<b>P.U.HT</b> <b>94,50 €</b>
B	<b>31499</b>	L. 23 x l. 9 x H. 5 cm	x 5	<b>2,90 €</b>
B	<b>32039</b>	L. 30 x l. 13 x H. 5 cm	x 5	<b>10,40 €</b>



ART DE LA TABLE



## Utah Copper et Sahara Black

En mélamine. Le design du cuivre mais les avantages de la mélamine : léger, pratique, facile à nettoyer, durable. Résistant aux ébréchantures et à la casse.



Plateau cuivre UTAH

<b>1011286</b>	GN 1/1 - l 153 x P 32,5 x H 1,5 cm
<b>1011287</b>	GN 1/2 - l 132,5 x P 26,5 x H 1,5 cm
<b>1011288</b>	GN 1/3 - l 132,5 x P 17,6 x H 1,5 cm
<b>1011289</b>	GN 1/4 - l 126,5 x P 16,2 x H 1,5 cm
<b>1011290</b>	GN 1/6 - l 117,6 x P 16,2 x H 1,5 cm
<b>1011294</b>	Ø 28,5 x H 1,5 cm



<b>P.U.HT</b>	
x 6	<b>65,00 €</b>
x 6	<b>36,75 €</b>
x 6	<b>26,75 €</b>
x 6	<b>21,25 €</b>
x 6	<b>15,50 €</b>
x 6	<b>28,25 €</b>

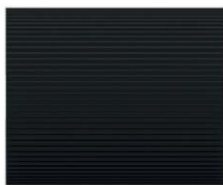

Plateau Noir SAHARA

<b>1011303</b>	GN 1/2 - L. 32,5 x l. 26,5 x H 1,5 cm
<b>1011302</b>	GN 1/3 - L. 32,5 x l. 17,6 x H 1,5 cm

Disponible en finition bois.  
Nous consulter.



<b>P.U.HT</b>	
x 6	<b>27,00 €</b>
x 6	<b>18,50 €</b>



Support métal droit

<b>GN 1/2 - l 32,5 x P 26,5 cm</b>	<b>P.U.HT</b>
<b>1011306</b> H 12 cm	x 4 <b>32,50 €</b>
<b>1011305</b> H 17 cm	x 4 <b>36,50 €</b>

<b>GN 1/3 - l 32,5 x P 17,6 cm</b>	<b>P.U.HT</b>
<b>1011300</b> H 12 cm	x 4 <b>27,50 €</b>
<b>1011301</b> H 17 cm	x 4 <b>28,75 €</b>

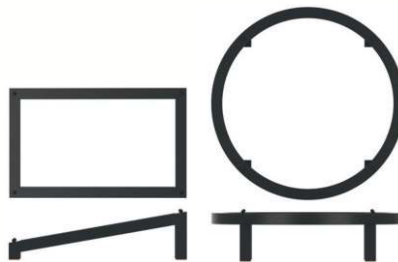

Support métal incliné

<b>H 7 cm</b>	<b>P.U.HT</b>
<b>1011304</b> GN 1/2 - l 32,5 x P 26,5 cm	x 4 <b>35,25 €</b>
<b>1011308</b> GN 1/3 - l 32,5 x P 17,6 cm	x 4 <b>28,75 €</b>

Support métal rond

<b>H 7 cm</b>	<b>P.U.HT</b>
<b>1011307</b> Ø 28,5 cm	x 4 <b>28,25 €</b>



Plat cuivre UTAH

<b>1011291</b>	l 32,5 x P 17,6 x H 1,5 cm
----------------	----------------------------



x 6

**P.U.HT**

**28,25 €**



Plat cuivre UTAH

<b>1011293</b>	l 34,5 x P 25 x H 3,5 cm
----------------	--------------------------



x 6

**P.U.HT**

**39,50 €**



Plat Cuivre UTAH

<b>1011292</b>	Ø 26 x H 1,5 cm
----------------	-----------------



x 6

**P.U.HT**

**28,25 €**



Saladier noir / cuivre UTAH

<b>1011296</b>	Ø 26,5 x 11,5 cm
<b>1011297</b>	Ø 20 x 8,5 cm
<b>1011298</b>	Ø 16 x 7 cm



x 6

**P.U.HT**

**34,00 €**

**18,50 €**

**13,00 €**



Gobelet cuivre / noir UTAH

<b>1011299</b>	Ø 9,5 cm - 34 cl
----------------	------------------



x 6

**P.U.HT**

**7,80 €**



Cloche

<b>1011295</b>	Ø 25,5 x H 16,2 cm
----------------	--------------------



x 3

**P.U.HT**

**21,25 €**

# Acrylic<sup>3</sup>

En acrylique, au design givré.

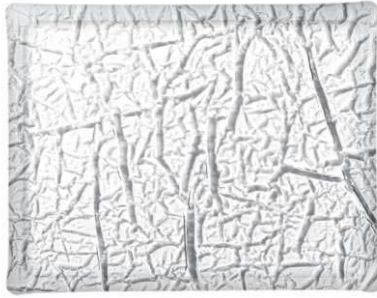

**Plateau Transparent givré**  
**1008485** L. 46 x l. 36 cm x 2 **P.U.HT 57,00 €**  
**1008482** L. 37 x l. 28 cm x 2 **41,75 €**



**Cube Transparent givré**  
**1008479** L. 20 x P. 20 x H. 23 cm x 1 **P.U.HT 52,00 €**  
**1008476** L. 18 x P. 18 x H. 15 cm x 1 **38,50 €**  
**1008473** L. 15 x P. 15 x H. 8 cm x 1 **28,00 €**



**Plateau Noir perle**  
**1008486** L. 46 x l. 36 cm x 2 **P.U.HT 63,00 €**  
**1008484** L. 37 x l. 28 cm x 2 **45,50 €**



**Cube Noir perle**  
**1008480** L. 20 x P. 20 x H. 23 cm x 1 **P.U.HT 57,00 €**  
**1008477** L. 18 x P. 18 x H. 15 cm x 1 **41,25 €**  
**1008474** L. 15 x P. 15 x H. 8 cm x 1 **29,25 €**



**Plateau Rouge baccara**  
**1008487** L. 46 x l. 36 cm x 2 **P.U.HT 63,00 €**  
**1008483** L. 37 x l. 28 cm x 2 **45,50 €**



**Cube Rouge baccara**  
**1008481** L. 20 x P. 20 x H. 23 cm x 1 **P.U.HT 57,00 €**  
**1008478** L. 18 x P. 18 x H. 15 cm x 1 **41,25 €**  
**1008475** L. 15 x P. 15 x H. 8 cm x 1 **29,25 €**

## Présentoir PAP 3 marches

En acrylique. Concept de présentation adapté aux contraintes des vitrines réfrigérées et des buffets.



Décor glace

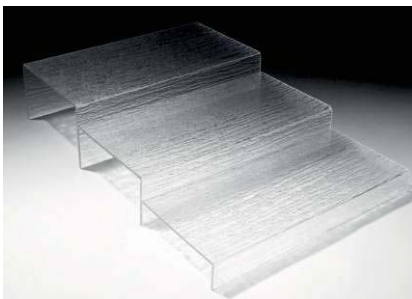

**Transparent**  
**1001247** L. 22, 20 et 18 x H. 12, 8 et 4 cm x 1 **P.U.HT 81,50 €**

Pour une présentation en escalier



**Noir**  
**1001248** L. 22, 20 et 18 x H. 12, 8 et 4 cm x 1 **P.U.HT 111,00 €**

## Plat acrylique PAP



En acrylique. Valorise les présentations traiteurs, pâtisseries, chocolatiers, sandwicheries,... Le produit s'entretient avec un lavage à l'eau savonneuse.

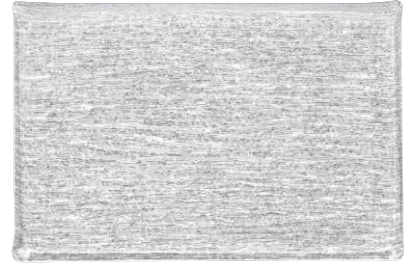

**Transparent**  
**63131** L. 60 x l. 40 cm x 6 **P.U.HT 49,75 €**  
**63132P** L. 53 x l. 32,5 cm x 6 **39,75 €**  
**63795P** L. 40 x l. 30 cm x 6 **35,50 €**



**Noir**  
**1001246** L. 60 x l. 40 cm x 6 **P.U.HT 60,00 €**  
**1001245** L. 53 x l. 32,5 cm x 6 **47,75 €**  
**1001244** L. 40 x l. 30 cm x 6 **42,50 €**

## Plat acrylique PAP2



En acrylique.



**Goutte d'eau**  
**1001480** L. 60 x l. 40 cm x 6 **P.U.HT 58,00 €**  
**1001474** L. 60 x l. 13,3 cm x 6 **25,00 €**  
**1001477** L. 40 x l. 30 cm x 6 **31,25 €**  
**1001483** L. 40 x l. 20 cm x 6 **21,00 €**



**Réglisse**  
**1001481** L. 60 x l. 40 cm x 6 **P.U.HT 62,50 €**  
**1001475** L. 60 x l. 13,3 cm x 6 **28,50 €**  
**1001478** L. 40 x l. 30 cm x 6 **34,25 €**  
**1001484** L. 40 x l. 20 cm x 6 **22,50 €**

# TECHNOLOGIE ET PASSION DANS LA CUISINE

**pujadas**<sup>®</sup>

A VOLLRATH<sup>®</sup> COMPANY

PROFESSIONAL COOKWARE

VOTRE  
PARTENAIRE  
POUR LA  
CUISINE



**SP3**

gastronorme inox 18/10  
avec pointes d'empilage anti-coincement



**mirage**<sup>®</sup>  
INDUCTION  
plaque induction

V I O L E T  
C O L L E C T I O N



your allergen free colour

préparez et servez des plats sans allergènes



**KOOL-TOUCH**<sup>®</sup>  
pince

nouveau !

## Présentoir

Présentoir bambou avec 3 bols mélamine blancs.



		P.U.HT
1013664	L. 49,5 x l. 16 x H. 8,5 cm - Bols 1,1 L x 1	67,00 €
1013663	L. 40 x l. 13 x H. 6 cm - Bols 0,5 L x 1	41,00 €
1013662P	L. 29 x l. 11 x H. 3,5 cm - Bols 0,2 L x 1	33,25 €

## Présentoir à pâtisserie



		P.U.HT
Inox satiné		
A 1013669P	Ø 30,5 x H 9 cm	x 1 38,25 €
Cloche		
B 1013670P	Ø 30 x H 11,5 cm	x 1 4,50 €
Mélamine		
C 1013605	Ø 31 x H 8 cm	x 1 24,25 €
Inox et cloche		
D 1013654	Ø 32,5 x H 18 cm	x 1 29,75 €

## Bonbonnière

En verre avec cuillère à manche aimanté revêtu de silicone, couvercle à visser pour conserver les arômes.



		P.U.HT
3 L		
1013686P	Ø 20 x H 18 cm	x 1 8,50 €

## Cube

En acrylique.  
Avec couvercle.

solia



		P.U.HT
1004299P	L. 25 X l. 25 X H. 25 cm	x 1 68,00 €
1004301P	L. 20 X l. 20 X H. 20 cm	x 1 46,75 €
1004300P	L. 15 X l. 15 X H. 15 cm	x 1 25,25 €
1004302P	L. 10 X l. 10 X H. 10 cm	x 1 12,60 €

APS

nouveau !

## Présentoir à pâtisserie

En ardoise véritable. Présentoir à gâteaux tournant.



		P.U.HT
1013606P	Ø 32 x H 2,5 cm	x 1 16,25 €

APS

## Plateau effet ardoise

En mélamine. Pieds en silicone anti-dérapants.



		P.U.HT
1013592	GN 1/1 - 53 x 32,5 cm	x 4 38,25 €
1000022P	GN 1/2 - 32,5 x 26,5 cm	x 4 20,25 €
1000023P	GN 1/3 - 32,5 x 17,6 cm	x 6 13,90 €
1000024P	GN 1/4 - 26,5 x 16,2 cm	x 6 11,10 €

APS

## Plat de présentation Vestah

En mélamine. Ultra léger, ultra plat. Idéal pour mettre en valeur vos présentations.

PLATEX  
1<sup>er</sup> Fabricant Français de Plateaux  
Made in France



		P.U.HT
1001487P	L. 60 x l. 40 cm	x 6 35,25 €

# BARCLAY



## Barclay

Set de 3 présentoirs pour mettre de la hauteur sur vos buffets.



Cube bois bambou  
**1011082** H. 13 - 18 - 23 cm x 1 **P.U. HT 83,00 €**



Cube bois Noir  
**1008121** H. 13 - 18 - 23 cm x 1 **P.U. HT 79,00 €**



Cube inox brossé  
**1008122P** H. 13 - 18 - 23 cm x 1 **P.U. HT 118,00 €**



Cylindre inox brossé  
**1008123** Ø 15 - 18 - 20 cm  
 H. 8 - 15 - 23 cm x 1 **P.U. HT 104,00 €**



## STAND STAR

## Stand star

En métal avec revêtement plastique noir anti-glisse. Empilable. Passe au lave-vaisselle.



Noir  
**1008256P** E H. 8 cm x 2 **P.U. HT 14,10 €**  
**1008255P** E H. 12 cm x 2 **P.U. HT 16,75 €**  
**1008254P** E H. 18 cm x 2 **P.U. HT 19,00 €**

## Non slip

En acier chromé. Présentoir anti-glisse, plateau noir antidérapant. L. 15 x l. 15 cm.



Fil chromé  
**1011085** Set de 3  
 H. 5 - 7,5 - 10 cm x 1 **P.U. HT 53,50 €**





## Write-on

En bambou naturel avec une surface en ardoise pour écriture.  
Base amovible qui permet de transformer le présentoir en bac de rangement.



Rond		☐	P.U. HT
<b>1008118</b>	Ø 12,5 x H. 12,5 cm	x 1	<b>20,25 €</b>
<b>1008119</b>	Ø 15 x H. 20,5 cm	x 1	<b>32,75 €</b>
<b>1008120</b>	Ø 23 x H. 25,5 cm	x 1	<b>56,00 €</b>



Carré		☐	P.U. HT
<b>1008115</b>	L. 10 x l. 10 x H. 14 cm	x 1	<b>15,50 €</b>
<b>1008116</b>	L. 15 x l. 15 x H. 17,5 cm	x 1	<b>25,00 €</b>



Rectangle		☐	P.U. HT
<b>1008117</b>	L. 33 x l. 20,5 x H. 17,5 cm	x 1	<b>43,50 €</b>

## Rustic

Set de 3 présentoirs bois avec 1 face ardoise pour écriture au feutre craie.  
Grand : L. 49 x l. 34,5 x H. 26,5 cm  
Moyen : L. 40,5 x l. 30 x H. 23,5 cm  
Petit : L. 35 x l. 25,5 x H. 18 cm



**1011078** Naturel x 1 **P.U. HT 77,00 €**

## Cascade

Set de 3 présentoirs bois.  
Grand : L. 56 x l. 18 x H. 18 cm  
Moyen : L. 48,5 x l. 18 x H. 15,5 cm  
Petit : L. 44 x l. 18 x H. 11,5 cm



**1011080** Bois acacia x 1 **P.U. HT 144,00 €**

## COLLECTION NATURE



## Collection Nature

En bois de noyer. Comme une bonne recette italienne, c'est la qualité des ingrédients, pas la quantité qui fait la différence. Le bois avec son caractère naturel donne à chaque ambiance une touche confortable et chaleureuse. Zepé : Italian Design, qualité supérieure.



Set réfrigéré avec couvercle

Set réfrigéré inox

Set réfrigéré  
(planche polyéthylène)Set réfrigéré  
Granit noirGN1/1 :  
L. 53 x l. 32,5 x H. 5 cm

1011003

1011004

1011005

1011007

P.U H.T

422,00 €

296,00 €

336,00 €

441,00 €

GN1/2 :  
L. 26,5 x l. 32,5 x H. 5 cm

1011009

1011010

1011012



x 1

x 1

x 1

P.U H.T

235,00 €

255,00 €

301,00 €

Donnez de la hauteur  
à vos présentoirs !



Set de 12 pieds

Dimensions :

Pied : L. 3 x l. 3 x H. 5 cm

Ref :

1011017



x 1

P.U H.T

60,50 €



Set de 3 cubes

Dimensions :

Petit : L. 14 x l. 21 x H. 14 cm  
Moyen : L. 17,5 x l. 21 x H. 17,5 cm  
Grand : L. 21 x l. 21 x H. 21 cm

Ref :

1011023



x 1

P.U H.T

252,00 €



Set de 3 ponts

Dimensions :

Petit : L. 32,5 x l. 17 x H. 9,5 cm  
Moyen : L. 36 x l. 17 x H. 14,5 cm  
Grand : L. 40 x l. 17 x H. 19,5 cm

Ref :

1011024



x 1

P.U H.T

226,00 €



Distributeur à jus de fruits 6 L

Dimensions : L. 18,5 x P. 33,5 x H. 58 cm

Ref : **1011018**

x 1

P.U.H.T **497,00 €**



Distributeur à céréales 2 x 3,5 L

L. 30 x P. 17 x H. 55,5 cm

Ref : **1011020**

x 1

P.U.H.T **548,00 €**



Distributeur à céréales 3,5 L

L. 15 x P. 17 x H. 55,5 cm

Ref : **1011019**

x 1

P.U.H.T **306,00 €**



Présentoir 2 carafes (livré avec 2 carafes en verre)

Dimensions : L. 32,5 x l. 17 x H. 29 cm

Ref : **1011022**

x 1

P.U.H.T **156,00 €**



Présentoir + Bols (livré avec 4 bols en porcelaine Ø 14 cm et couvercles plastiques)

Bas : L. 32 x l. 17 x H. 12 cm  
Haut : L. 36 x l. 17 x H. 23 cm

Ref : **1011021**

x 1

P.U.H.T **408,00 €**



Présentoir pain\*

GN1/1 : L. 53 x l. 32,5 x H. 5 cm

P.U.H.T **166,00 €**

GN1/2 : L. 26,5 x l. 32,5 x H. 5 cm

x 1

P.U.H.T **120,00 €**

\* Planche à découper (1011016) en option



# DEGRENNE

P A R I S

BUFFET EVENTO



## EVENTO Gourmet Salé

C'est le lieu de la gastronomie et de la cuisine cosmopolite. Les contenants maintiennent au chaud les aliments (bacon, oeufs brouillés, nouilles...) ou au frais (charcuterie, fromage, sushis...). Deux matériaux proches de l'univers culinaire sont privilégiés : l'acier et la porcelaine.

Sélection de la gamme Evento  
Pour découvrir plus de produits,  
consultez votre magasin



nouveau !

### Composition Gourmet salé :

#### Chafing Dish

<b>1014021</b>	Chafing dish en acier brossé Ø 35,5 cm - 3 L - Bac porcelaine inclus	x 1	<b>420,00 €</b>
<b>1014030</b>	Demi-bac porcelaine L. 29 x l. 15 x H. 4,5 cm	x 1	<b>31,50 €</b>

#### Set Réfrigéré

<b>1013791</b>	Cadre en acier brossé et bac plastique noir GN 1/1 - L. 53 x l. 32,5 cm	x 1	<b>223,00 €</b>
<b>1014011</b>	Couvercle roll top GN 1/1 - 53 x 32,5 cm	x 1	<b>73,00 €</b>
<b>1014012</b>	Plaque réfrigérante noire GN 1/1 - 53 x 32,5 cm	x 1	<b>22,25 €</b>
<b>1013793</b>	Plateau porcelaine blanc GN 2/3 - 35,4 x 32,5 cm	x 1	<b>36,75 €</b>
<b>1013795</b>	Plateau porcelaine blanc GN 1/3 - 32,5 x 17,5 cm	x 1	<b>23,75 €</b>
<b>1013794</b>	Plateau porcelaine blanc GN 1/2 - 26 x 32,5 cm	x 1	<b>30,00 €</b>
<b>1014006</b>	Plateau acrylique noir 2 trous pour bols Ø 22 cm - GN 1/1 - 53 x 32,5 cm	x 1	<b>102,00 €</b>
<b>1014005</b>	Plateau acrylique noir 1 trou pour bol Ø 22 cm - GN 1/2 - 26 x 32,5 cm	x 1	<b>52,00 €</b>
<b>1014008</b>	Bol porcelaine Ø 22 cm - 2 L	x 6	<b>22,00 €</b>

# Le Buffet EVENTO

## EVENTO Vitaminé

Evocateur de fraîcheur, de bien être et de vitalité, il propose les contenants destinés aux laitages, jus de fruits, céréales, fruits secs ... Il utilise des matériaux neutres ou transparents aux couleurs fraîches comme le verre, l'acrylique givré et la porcelaine.

## EVENTO Gourmand Sucré

Evocateur de tradition et de convivialité, il regroupe les pains, les viennoiseries, les pâtisseries, les confitures, les miels... Il est constitué de contenants à base de matériaux traditionnels : bois, vannerie...

nouveau !

### Composition Vitaminé :

1013791	Cadre en acier brossé et bac plastique noir GN 1/1 - L. 53 x l. 32,5 cm	x1	223,00 €		
1014011	Couvercle roll top GN 1/1 - L. 53 x l. 32,5 cm	x1	73,00 €		
1014012	Plaque réfrigérante noire GN 1/1 - L. 53 x l. 32,5 cm	x1	22,25 €		
1013796	Plat creux en porcelaine blanche GN 1/3 - L. 32,5 x l. 17,5 cm	x1	26,50 €		
1014007	Plateau acrylique noir 2 trous pour bols Ø 14 cm ou carafes - GN 1/3 - L. 32,5 x l. 17,5 cm	x1	46,50 €		
1014018	Carafe à lait en porcelaine - 1,2 L	x1	18,50 €		
1014017	Carafe à jus de fruits en verre soufflé bouche - 1,2 L	x1	18,25 €		
1014019	Bouchon silicone pour carafe	x1	7,50 €		
1014031	Support rond bas pour bol, panier ou plateau Ø 25 x H. 13 cm	x1	46,75 €		
1014032	Support rond haut pour bol, panier ou plateau Ø 25 x H. 26 cm	x1	53,50 €		
1014044	Bol porcelaine Ø 28 cm	x1	38,00 €		
1014009	Bol porcelaine Ø 14 cm	x6	22,25 €		
1014014	Distributeur à jus de fruits 4 L inox brossé	x1	331,00 €		
1014013	Distributeur à jus de fruits 4 L inox poli-miroir	x1	331,00 €		
1014052	Etiquette porcelaine blanche + support acier	x1	9,70 €		
1014050	Support pour couverts de service en porcelaine blanche	x1	9,80 €		

nouveau !

### Composition Gourmand sucré :

1014031	Support rond bas pour bol, panier ou plateau Ø 25 x H. 13 cm	x1	46,75 €		
1014032	Support rond haut pour bol, panier ou plateau Ø 25 x H. 26 cm	x1	53,50 €		
1014040	Panier en PP noir Ø 32 cm	x1	23,50 €		
1014002	Plateau en verre trempé noir Ø 32 cm	x1	35,25 €		
1014041	Panier en PP noir L. 54 x l. 34 x H. 8 cm	x1	46,50 €		
1014038	Support rectangulaire noir 3 niveaux	x1	197,00 €		
1014046	Planche à pain en bambou GN 1/1	x1	65,50 €		



### Set réfrigéré 3 compartiments\*

- Composition du set :
- 1 base en bois mélaminé L. 50 x l. 42 x H. 33 cm
  - 2 paniers à pain en osier GN 1/3
  - 3 couvercles transparents GN 2/3
  - 1 bac inox GN 1/2 hauteur 20 cm
  - 1 bac inox GN 1/2 hauteur 40 cm
  - 1 gel frigorifique L. 20 x l. 19 cm



Set réfrigéré complet  **P.U.HT**  
**1009783** L. 126 x l. 42 x H. 33 cm x 1 **325,00 €**

### Set réfrigéré Suprem bol\*

- Composition du set:
- 1 base en bois mélaminé L. 32 x l. 32 x H. 16,5 cm - Trou Ø 23 cm
  - 1 couvercle à charnière, perforé
  - 1 bol en verre de 3L / Ø 23 cm
  - 1 passoire inox Ø 22 cm
  - 1 cloche inox Ø 24 cm



Set réfrigéré ouvert complet  **P.U.HT**  
**1009781** L. 32 x l. 80 x H. 16,5 cm x 1 **228,00 €**

### Plateau de présentation

Plateau à compartiments amovibles, pour pouvoir l'utiliser en range couverts, pour les sachets à thé ou autre.



Plateau de présentation  **P.U.HT**  
**1009780** L. 30 x P. 30 x H. 6 cm x 1 **66,50 €**

### Set réfrigéré 3 compartiments\*

- Composition du set:
- 1 base en bois mélaminé avec 3 trous Ø 10 cm
  - 1 bac pour set réfrigéré L. 36,9 x l. 12,4 x H. 2,4 cm
  - 1 gel frigorifique L. 20 x l. 19 cm



Set réfrigéré complet  **P.U.HT**  
**1009782** L. 40,5 x l. 16 x H. 12 cm x 1 **112,00 €**

### Porte-serviettes

Plateau pour serviettes carrées de 16,5 cm.



Porte-serviettes  **P.U.HT**  
**1009786** L. 21,5 x l. 21,5 x H. 6,5 cm x 1 **45,00 €**



A - Bouteille en verre avec couvercle vert  **P.U.HT**  
**1009768** 1 L x 1 **11,30 €**

B - Pichet isotherme double paroi  **P.U.HT**  
**1009772** 1,5 L x 1 **31,50 €**

C - Etiquette  **P.U.HT**  
**1009774** Pichet lait / thé x 1 **2,80 €**

\*Les accessoires peuvent être vendus séparément nous consulter



# SUPERBOX

nouveau !

## Superbox

En bois. «Superbox» est un concept de buffet multifonctionnel qui s'adapte en hauteur et en profondeur à tous les espaces. Les boîtes empilables et antidérapantes sont réversibles et peuvent être associées à des plateaux Gastronomique ou être utilisées individuellement comme contenant.



GN 1/1 - 53 x 32,5 cm



P.U.HT

1013541	Caisse bois foncé	x 1	29,25 €
1013540	Caisse bois clair	x 1	29,25 €
1013543	Plateau mélamine noir	x 2	34,25 €
1013542	Plateau mélamine blanc	x 2	34,25 €
1014138	Bac plastique réfrigéré	x 1	29,25 €
1007471P	Couvercle roll top	x 1	62,50 €



GN 2/4 - 53 x 16,2 cm



P.U.HT

1013545	Caisse bois foncé	x 1	24,25 €
1013544	Caisse bois clair	x 1	24,25 €
1013547	Plateau mélamine noir	x 5	20,25 €
1013546	Plateau mélamine blanc	x 5	20,25 €



GN 1/2 - 32,5 x 26,5 cm



P.U.HT

1013549	Caisse bois foncé	x 1	18,25 €
1013548	Caisse bois clair	x 1	18,25 €
1013551	Plateau mélamine noir	x 5	18,50 €
1013550	Plateau mélamine blanc	x 5	18,50 €
1014139	Bac plastique réfrigéré	x 1	24,25 €



GN 1/4 - 26,5 x 16,2 cm



P.U.HT

1013553	Caisse bois foncé	x 1	15,25 €
1013552	Caisse bois clair	x 1	15,25 €
1013556	Plateau mélamine noir	x 5	10,50 €
1013554	Plateau mélamine blanc	x 5	10,50 €



Présentoir 43 x 17 cm  
+ 3 bols 2 L en verre



P.U.HT

1014054	Bois wengé	x 1	82,50 €
1014053	Bois blanc	x 1	82,50 €

## Distributeur à lait réfrigéré



Socle acrylique, indicateur en porcelaine inclus, plaque de froid dans le socle.



4 L

1003375

L. 31 x l. 21 x H. 42 cm



P.U.HT

x 1 266,00 €

## Distributeur Top Kilner



Ouverture à Clip avec joint d'étanchéité remplaçable. Robinet avec ouverture / fermeture pratique.



8 L

1007065P

L. 28 x l. 21 x H. 36,3 cm



P.U.HT

x 1 49,00 €

## Corbeille Basket



Couvercle en SAN.



Panier GN 1/1

A 1007470P L. 56,5 x l. 36 x H. 10 cm

Couvercle basculant

B 1007471P L. 53 x l. 32,5 x H. 17 cm



P.U.HT

x 1 29,00 €

x 1 62,50 €

## Boîte à thé



En bois clair avec fenêtre, 12 compartiments, pour environ 144 sachets.



1013666P

L. 31 x l. 28 x H. 9 cm



P.U.HT

x 1 23,25 €

## Brotstation



Planche et boîtes en hêtre, plateau en mélamine.



Planche à pain

A 1013667 L. 52 x l. 34 x H. 2 cm

Boîte

B 1013617 L. 34 x l. 26 x H. 20 cm

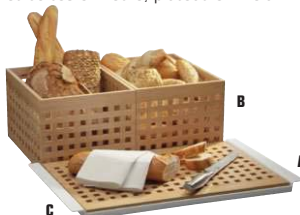
B 1013618 L. 34 x l. 26 x H. 12 cm

Plateau pour planche

C 1013668 L. 59,5 x l. 35,5 x H. 3,5 cm



P.U.HT

x 6 33,25 €



P.U.HT

x 1 56,50 €



P.U.HT

x 1 50,50 €



P.U.HT

x 1 37,25 €

## Big GN



En métal chromé.



Présentoir

1013558 L. 52 x l. 69 x H. 66 cm

Corbeille GN 1/1

1013559 L. 53 x l. 32,5 x H. 10 cm



P.U.HT

x 1 130,00 €

x 1 23,25 €

## Set réfrigéré

(Couvercle en option).  
En acrylique et inox.



**Présentoir blanc**  
**1003380P** L. 56,5 x l. 35 x H. 6,5 cm x 1 **P.U.HT 94,50 €**

Cloche basculante bouton chromé pour set GN1/1.



**Couvercle**  
**1012557P** L. 53 x l. 32,5 x H. 17 cm x 1 **P.U.HT 60,50 €**

## Distributeur à boisson

En inox et ABS. Distributeur isotherme de boissons chaudes ou froides.



**9,5 L**  
**1003377P** Ø 24 x H. 42 cm x 1 **P.U.HT 54,00 €**

## Distributeur à jus de fruits

Support inox, contenant en SAN. Tubes inox réfrigérants amovibles.



**8 L**  
**60067P** L. 37 x l. 28 x H. 55 cm x 1 **P.U.HT 184,00 €**

## Présentation fruits/céréales



**Présentoir 4 bols Ø 23 cm - 2,5 L**  
Support en métal chromé, bols en verre et couvercles à charnières, en acrylique.

**1003368** L. 39 x l. 31 x H. 66 cm x 1 **P.U.HT 170,00 €**



**Présentoir 3 bols Ø 23 cm - 2,5 L**  
Support en métal chromé, bols en verre et couvercles à charnières, en acrylique.

**1003369** L. 61 x l. 24 x H. 35 cm x 1 **P.U.HT 120,00 €**

## Distributeur à céréales

Support inox, contenant en SAN. Bol amovible pour un remplissage et un nettoyage aisés.



**A - 2 x 4,5 L**  
**69118P** L. 35 x l. 22 x H. 52 cm x 1 **P.U.HT 123,00 €**

**B - 4,5 L**  
**69117P** L. 22 x l. 17,5 x H. 52 cm x 1 **P.U.HT 66,50 €**

nouveau !

## Porte agrumes

3 niveaux en fil chromé.

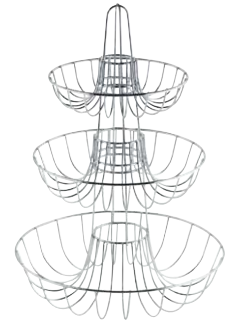

**1013652** Ø 30,2 x H. 42 cm x 1 **P.U.HT 32,00 €**

## Corbeille à fruits

En métal filé noir.



A



B



C

Noir  
**A 1013468P** Ø 27,5 x H. 14 cm x 1 **P.U.HT 24,75 €**  
**B 1013469P** Ø 23 x H. 26 cm x 1 **P.U.HT 24,75 €**  
**C 1013470P** Ø 22,5 x H. 32,5 cm x 1 **P.U.HT 24,75 €**



## Corbeille 2 anses

En osier.



**1000095P** L. 50 x l. 46 x H. 16 cm x 1 **P.U.HT 23,75 €**

## Présentoir à céréales

Support en acrylique. Contenants en ABS. Couvercle hermétique pour conserver au mieux le contenu du pichet.



**2 x 1,5 L**  
**1003370** L. 26 x l. 16,5 x H. 29 cm. Présentoir H. 4 cm. x 1 **P.U.HT 64,50 €**

nouveau !

SERAX

## Porte-bouteilles

En fer peint.  
Parfait pour la présentation des jus de fruits sur un buffet.  
Pour bouteilles de Ø 9 cm maximum.



**1013521** L. 35 x l. 26 x H. 40 cm x 1 **P.U.HT 81,00 €**



nouveau !

## Grand Master

En fil métallique époxy noir. Lavage à la main uniquement.



A



B

Modèle Transformer avec pieds rabattables. Peut accueillir des bacs GN.



C



D

	<b>Panier rectangle</b>				
A	<b>1013657</b>	L. 38 x l. 20,5 x H. 11 cm	x 1	<b>P.U.HT</b>	<b>22,25 €</b>
A	<b>1013658</b>	L. 53 x l. 33 x H. 14 cm	x 1		<b>37,50 €</b>
	<b>Panier Transformer</b>				
B	<b>1013660</b>	L. 32 x l. 25,5 x H. 13 cm	x 1		<b>38,50 €</b>
C	<b>1013659</b>	L. 52 x l. 30,5 x H. 13 cm	x 1		<b>51,00 €</b>
	<b>Panier incliné</b>				
D	<b>1013655</b>	L. 30,5 x l. 30,5 x H. 11,5 cm	x 1		<b>33,75 €</b>
D	<b>1013656</b>	L. 49,5 x l. 38 x H. 20 cm	x 1		<b>62,50 €</b>

## Claie à porter



	<b>Noir</b>				
	<b>1013661</b>	L. 29 x l. 29 x H. 47,5 cm	x 1	<b>P.U.HT</b>	<b>42,00 €</b>

## Corbeille

En fil d'innox. Facile d'entretien et résistant.



**1001555P** E L. 35,3 x l. 15 x H. 5,2 cm x 1 **P.U.HT** **10,70 €**

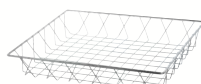

**1001556P** E L. 35,5 x l. 30,5 x H. 5,5 cm x 1 **P.U.HT** **11,60 €**

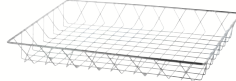

**1001557P** E L. 45,2 x l. 30,5 x H. 5,5 cm x 1 **P.U.HT** **15,50 €**

## Manne osier

Utile pour transporter ou présenter des viennoiseries ou toutes sortes de pains.



**1000102P** L. 60 x l. 39 x H. 13 cm x 1 **P.U.HT** **79,50 €**

## Manne osier doublée

Corbeille rectangulaire en osier doublée toile de jute. Housse amovible grâce au lacet. Lavable à 40°C.



**1000096P** L. 40 x l. 30 x H. 10 cm x 1 **P.U.HT** **9,00 €**

## Corbeille double

En vannerie artificielle sur support inox. Montage facile. Lavable au lave-vaisselle.



**Corbeille** L. 36 x l. 27 x H. 9 cm **P.U.HT**  
**Support inox** L. 40 x l. 36 x H. 34 cm **P.U.HT**  
**62681P** x 1 **35,50 €**

**1er PRIX**

## Manne polypropylène



**52660P** E L. 40 x l. 28 x H. 8 cm x 1 **P.U.HT** **8,00 €**

## Claie à porter osier

En osier blanc.



**1000094P** Ø 31 x l. 29 x H. 52,5 cm x 1 **P.U.HT** **88,00 €**

nouveau !

## Cultur Form

En métal chromé et bois. Set de 5 éléments : socle + paroi en bois foncé + 3 rampes profondes.



**1013591** L. 26 x l. 18 x H. 43 cm x 1 **P.U.HT** **94,50 €**

## Présentation fruits/céréales

En inox et SAN



**Présentoir 4 niveaux** **P.U.HT**  
**1003374P** L. 19 x l. 31 x H. 53 cm x 1 **54,50 €**

nouveau !

## Snack

En mélamine. Présentoir pour apéritifs. Peut aussi servir de présentoir à thés et infusions.



**1013557P** L. 17,5 x l. 7,5 x H. 4,5 cm x 1 **P.U.HT** **5,10 €**

nouveau !

### Evento

En inox brossé avec bac porcelaine. Couvercle avec gouttière, en verre trempé. Charnière avec vérin et amortisseur pour un réel confort d'utilisation et une fermeture en douceur. Système de récupération d'eau de condensation. Support chafing dish inox pour résistance ou porte brûleur non inclus. Utilisation sur plaque induction, avec résistance électrique ou porte brûleur avec gel combustible.



Chafing-dish 3 L

L. 35,5 x l. 41 x H. 15 cm  
**1014021** Ø 35 x H. 4 cm

x 1 **P.U.HT**  
**420,00 €**

### Chafing-dish Roll top

Bâti tout inox. Couvercle basculant de type "Roll Top", ajustable à 90°C et 180°C. Thermostat permettant le réglage de la température. Alimentation : 230 V.

GARANTIE 1 an



A - Chafing-dish 13,5 L

Rectangulaire GN 1/1 - 900 W  
**1005707P** L. 68 x l. 48 x H. 44 cm

x 1 **P.U.HT**  
**482,00 €**

B - Chafing-dish 6,8 L

Rond Ø 45 x H. 45 cm - 500 W  
**1005708P** Bac Ø 36 cm

x 1 **P.U.HT**  
**371,00 €**

### Chafing-dish

Construction en polypropylène. Fonctionne suivant le principe du bain-marie. Compatible avec tous les bacs au format gastronomique de profondeur 65 mm ainsi que les couvercles basculants au format 1/1. Livré avec un bac GN 1/1 et un couvercle à poignée. Température maximum 85°C réglable au moyen d'un bouton de contrôle. Niveau de remplissage d'eau indiqué à l'intérieur du bac. Alimentation : 230 V. Puissance : 500 W. Poids : 5,1 kg.

GARANTIE 1 an



Chafing-dish 9 L

Rectangulaire GN 1/1  
**62764P** E L. 58,5 x l. 35,5 x H. 29 cm

x 1 **P.U.HT**  
**168,00 €**

Bâti en plastique noir résistant aux hautes températures. Thermostat permettant le réglage de la température. Livré avec bac Ø 36 cm. Alimentation 230 V. Puissance : 420 - 500 W.



Chafing-dish 6,8 L

Rond Ø 40 x H. 26 cm  
**1005709P** Bac Ø 36 cm

x 1 **P.U.HT**  
**135,00 €**



### Chafing-dish roll top

En inox. Design moderne et construction robuste. Couvercle Roll Top ajustable à 90° et 180°. Livré avec bac et brûleur. Pieds inox.



Chafing-dish 9 L

Rectangulaire GN 1/1 - 2 brûleurs  
**1001614P** L. 70 x l. 49 x H. 44 cm

x 1 **P.U.HT**  
**340,00 €**



Chafing-dish 6,8 L

Rond Ø 49 x H. 43 cm - 1 brûleur  
**1001615P** Bac Ø 40 cm

x 1 **P.U.HT**  
**308,00 €**



### Chafing-dish

En inox. Livré avec bac et brûleur.



Chafing-dish 9 L

Rectangulaire GN 1/1 - 2 brûleurs  
**1001616P** E L. 60 x l. 35 x H. 32 cm

x 1 **P.U.HT**  
**86,00 €**



Chafing-dish 3,5 L

Rond Ø 42 x H. 28 cm - 1 brûleur  
**1001617P** Bac Ø 34 cm

x 1 **P.U.HT**  
**72,00 €**

## GEL COMBUSTIBLE

### Gel combustible\*

Gel combustible Ethanol pour chafing-dish.  
Durée de combustion 3 H. Ø 8,5 x H. 5,5 cm.



Boîte de 200 g

**1007522\***

x 24

P.U.HT  
**0,81 €**

\*Dangereux. Respecter les précautions d'emploi.  
Produit conforme à la législation française.

Lot de 3 x 80 g de gel combustible Ethanol pour sets à fondue. Durée de combustion 3x 90 mn. Ø 8,5 x H. 3 cm.



Lot de 3 barquettes de 80 g

**1007523\***

x 1

P.U.HT  
**2,80 €**

\*Dangereux. Respecter les précautions d'emploi.  
Produit conforme à la législation française.

Combustion propre et inodore



Bouteille de gel combustible Ethanol de 1L.



Bouteille 1 L

**1007524P\***

x 12

P.U.HT  
**3,10 €**

\*Dangereux. Respecter les précautions d'emploi.  
Produit conforme à la législation française.

Bidon de gel combustible Ethanol de 5L.  
Pompe en option.



A - Bidon de 5 L

**1007525P\* E**

x 4

P.U.HT  
**13,10 €**

\*Dangereux. Respecter les précautions d'emploi.  
Produit conforme à la législation française.

B - Pompe

**1007526 E**

x 1

P.U.HT  
**13,90 €**

## RÉCHAUD

### Réchaud à gaz

2000 W.  
L. 34 x l. 28 x H. 12 cm.  
Livré sans cartouche.



Réchaud à gaz

**67612P**

x 1

P.U.HT  
**23,75 €**

Cartouche gaz\*

**67613P\***

2/3 H de combustion

x 28

P.U.HT  
**2,60 €**

\*Dangereux. Respecter les précautions d'emploi.  
Produit conforme à la législation française.

## Chauffe-plats à bougie

En acier chromé.



A **3500**

2 feux - L. 34 x l. 20 x H. 6,5 cm

x 1

P.U.HT  
**35,75 €**

B **60597**

1 feu - L. 20 x l. 19,5 x H. 6,5 cm

x 1

P.U.HT  
**30,00 €**

## ACCESSOIRES

### nouveau !

### Evento

En porcelaine.



1/2 bac

**1014030**

L. 26 x l. 15 x H. 4,5 cm

x 1

P.U.HT  
**31,50 €**

### Buffet Range

En porcelaine résistante.



Plat GN 1/1

**61484P**

L. 53 x l. 32,5 x H. 6,5 cm

x 1

P.U.HT  
**60,50 €**

### Porte-étiquettes inox

Fourni avec socle.



**67636P**

H. 20 cm

x 1

P.U.HT  
**45,25 €**

### Porte-étiquettes

En laiton chromé. Socle Ø 3,5 cm.



Paquet de 3

**65491P**

H. 9 cm

x 1

P.U.HT  
**45,00 €**

### Pince-étiquettes

En inox. Se positionne sur différents supports (plats, boîtes, vitrines, panières etc.). Réglable dans de multiples positions.



Boîte de 10

**65498P**

L. 6 x l. 4 cm

x 1

P.U.HT  
**32,75 €**

## nouveau !

### Tags



Double face flexible, facile à nettoyer. Livré avec 1 feutre craie et 8 supports. Effaçable avec une éponge humide.



A - Ardoise - Paquet de 20

**1014066P**

L. 23,9 x l. 17,2 cm

x 1

P.U.HT  
**13,10 €**

**1014065P**

L. 14,8 x l. 10,5 cm

x 1

P.U.HT  
**15,25 €**

B - Support en acrylique - Paquet de 10

**1014067P**

x 1

P.U.HT  
**6,00 €**

### Clip

Étiquette inox avec revêtement ardoise. Crochet inox pour se poser sur tout type de saladier, bac.



Ardoise

**1013653P**

L. 7,5 x H. 4,5 cm

x 6

P.U.HT  
**3,20 €**

### L Boards



En forme de L. Ardoises en acrylique noire très résistantes et très stables. Finition mat sur le devant et brillant au dos. Écriture au feutre craie. Effaçable à l'eau. Livré avec 1 feutre craie.



Ardoise - Paquet de 3

**1014064P**

L. 25 x H. 13 cm

x 1

P.U.HT  
**10,00 €**

**1014063P**

L. 33 x H. 17,5 cm

x 1

P.U.HT  
**13,10 €**

### Table Caddy



Ardoises de table sur socle bois. Avec une surface d'écriture sur les deux faces et une anse montée en bois dur sur une structure en métal. Peut servir de porte menu, porte ménagères ou de porte tapas par exemple.



Porte-accessoires

**1014060P**

L. 22 x l. 20 x H. 34 cm

x 6

P.U.HT  
**19,75 €**

### Silhouette



Surface d'écriture double face flexible. Livré avec 1 feutre craie. Effaçable avec une éponge humide.



Ardoise de table - Base bois

A **1014061P**

L. 21 x l. 6 x H. 32,5 cm

x 6

P.U.HT  
**13,10 €**

Ardoise de table - Base aluminium

B **1014062P**

L. 37 x l. 26 x H. 26 cm

x 6

P.U.HT  
**13,10 €**

## PLAQUE À INDUCTION

### Plaque à induction

**Bartscher** GARANTIE 1 an

Boîtier en acier inox. Surface en vitrocéramique Schott : qualité et rapidité de la conduction de chaleur, résistance aux rayures, presque incassable. Panneau de contrôle tactile en "Touch glass" avec affichage digital pour une meilleure étanchéité. Minuterie. 10 niveaux de puissance (400 à 3000 W). Thermostat de sécurité électronique.



	<b>IK30TCS</b>
Plage de température	60°C - 240° C
Puissance	3000 W
Alimentation	230 V
Dimensions (L x l x H)	33 x 41,5 x 10 cm
Poids	5,5 kg
Référence	🏷️ <b>69344P E</b>
P.U H.T	<b>265,00 €</b>

nouveau !

### Plaque à induction

**Bartscher** GARANTIE 1 an

Surface en verre, boîtier en plastique. Minuterie. Affichage digital. 10 niveaux de puissance (1100 à 2000 W). Protection électronique anti-surchauffe. Non prévu pour un usage intensif.



Plage de température	60°C - 240° C
Puissance	2000 W
Alimentation	230 V
Dimensions (L x l x H)	28,5 x 34 x 6,4 cm
Référence	<b>1013587</b>
P.U H.T	<b>69,50 €</b>

## PLAQUE CHAUFFANTE

nouveau !

### Plaque à induction

**APS** GARANTIE 1 an

Pour chafing dish, évite l'utilisation de combustible.



Puissance	900 W
Alimentation	230 V
Dimension utile	Ø 24 cm
Référence	<b>1013535</b>
P.U H.T	<b>130,00 €</b>

### Plaque à induction

**Bartscher** GARANTIE 1 an

Commande simple pour un travail efficace, réglage de la minuterie, de la puissance et de la température au moyen de la fonction Slide. Surface en verre, boîtier en acier inoxydable. Panneau de contrôle tactile avec affichage digital. Minuterie. Détection de casserole. 8 niveaux de puissance (500 - 2000 W). Thermostat de sécurité électronique.



Plage de température	60°C - 240° C
Puissance	2000 W
Alimentation	230 V
Dimensions (L x l x H)	33 x 40 x 6,3 cm
Référence	<b>1013588</b>
P.U H.T	<b>140,00 €</b>

nouveau !

### Plaque chauffante

**Bartscher** GARANTIE 1 an

Boîtier en aluminium, plaque en verre. Interrupteur marche/arrêt. Lampe témoin.



Plage de température	30 - 95 °C
Puissance	300 W
Alimentation	230 V
Dimensions (L x l x H)	66,6 x 55 x 4 cm
Dimension utile	GN 2/1
Référence	<b>1013586</b>
P.U H.T	<b>174,00 €</b>

### Plaque chauffante universelle

**Bartscher** GARANTIE 1 an

Plaque chauffante pour chafing dish. Thermostat de sécurité.



Puissance	450 W
Alimentation	220-230 V
Dimensions (Ø x H)	13,5 x 10 cm
Poids	1,2 kg
Référence	<b>70442P</b>
P.U H.T	<b>40,25 €</b>

## MARMITE À SOUPE

### Marmite à soupe

GARANTIE 1 an

En aluminium laqué époxy noir granité. Cuve et couvercle en inox. Thermostat automatique. Interrupteur variateur 70° et 95°C.



Capacité	8 L
Puissance	400 W
Alimentation	230 V
Dimensions (ø x H)	34,5 x 36 cm
Poids	4,5 kg
Référence	🏷️ <b>43011P E</b>
P.U H.T	<b>105,00 €</b>

nouveau !

### Marmite à soupe

**APS** GARANTIE 1 an

Polypropylène et inox. Récipient à soupe inox amovible, bain-marie électrique, louche, support circulaire inox.



	Marron	Noir
Capacité	10 L	
Thermostat maxi	80°C (± 10°C)	
Puissance	450-550 W	
Alimentation	230 V	
Dimensions (L x l x H)	38 x 38 x 36,5 cm	
Référence	<b>1013616</b>	<b>1013615</b>
P.U H.T	<b>130,00 €</b>	<b>130,00 €</b>

### Marmite à soupe

**HENDI** FOOD SERVICE EQUIPMENT

GARANTIE 1 an

Marmite en acier inoxydable 18/8. Bâti en polypropylène. Thermostat ajustable. Panneau de commande numérique tactile, avec affichage alterné de la température réglée ou la température en cours. Porte-carte pour le nom de la soupe dans le couvercle. Pieds en caoutchouc antidérapant.



Capacité	8 L
Plage de température	65°C - 95° C (en étapes de 1° C)
Puissance	450 W
Alimentation	230 V
Dimensions (Ø x H)	37 x 30 cm
Référence	<b>1013403</b>
P.U H.T	<b>83,00 €</b>

## PICHETS ISOTHERMES

### Pichet polyuréthane

Sans ampoule, isolant polyuréthane anti-choc. Ne passe pas au lave-vaisselle.



**60666P** E 60 cl  
**60667P** E 120 cl

x 1  
x 1

**P.U.HT**  
**16,75 €**  
**24,25 €**

### Pichet polypropylène

Isolation par ampoule de verre.



**71103P** 100 cl

x 1

**P.U.HT**  
**25,50 €**

### Jazz

En polypropylène. Pot isotherme blanc.



**62122P** E Ø 10,5 x H. 9,3 cm - 27 cl

x 1

**P.U.HT**  
**11,70 €**

### Pichet à pompe

En inox laqué. Isolation par double paroi inox.



**58386** E 500 cl  
**70640P** E 250 cl

x 1  
x 1

**P.U.HT**  
**57,50 €**  
**40,25 €**

### Etiquette autocollante

En plastique argenté. 4 étiquettes "café", 3 "eau chaude" et 3 "lait".



Sachet de 10  
**53360P**

x 1

**P.U.HT**  
**7,60 €**

**VOLLRATH**  
Outperform every day.

### Astoria

Pichet isotherme avec un revêtement de couleur qui résiste dans le temps. Isolation par ampoule de verre double paroi avec vide d'air.



**71095P** 100 cl - Rouge  
**71097P** 100 cl - Noir  
**71096P** Couvercle de rechange  
**71098P** Ampoule de rechange

x 1  
x 1  
x 1  
x 1

**P.U.HT**  
**41,25 €**  
**41,25 €**  
**6,20 €**  
**21,50 €**

### Easy clean

Isolation par double paroi avec vide d'air.



**70205P** E 120 cl  
**70204P** E 160 cl

x 1  
x 1

**P.U.HT**  
**20,00 €**  
**22,00 €**

Bouchon de rechange

**70206P** E Bleu - 120 et 160 cl

x 1

**P.U.HT**  
**1,90 €**

### Pichet isotherme

Incassable, double paroi inox. Bouchon poussoir. Ne passe pas au lave-vaisselle.



**1011589P** E 50 cl

x 1

**P.U.HT**  
**12,70 €**

### 1<sup>er</sup> PRIX

#### Pichet isotherme

Gamme de pichets isothermes incassables avec double paroi inox. Bouchon poussoir. Ne passe pas au lave-vaisselle.



**70637P** E 100 cl  
**70636P** E 200 cl

x 1  
x 1

**P.U.HT**  
**13,50 €**  
**21,50 €**

Bouchon de rechange 100 et 200 cl

**70639P** E

x 1

**P.U.HT**  
**8,20 €**

## VERSEUSES ISOTHERMES

### Inox

Produit incassable. Isolation par double paroi avec vide d'air. Couvercle avec ouverture à 180°C, facile d'entretien. Ne passe pas au lave-vaisselle.



**69312P** 30 cl

x 1

**P.U.HT**  
**59,00 €**

### Alizée

Corps inox finition satinée. Incassable. Isolation par double paroi avec vide d'air.



**71127P** 100 cl  
**71130P** 200 cl

x 1  
x 1

**P.U.HT**  
**56,50 €**  
**59,00 €**

### Pause café

Gamme de verseuses isothermes de couleurs pour égayer les buffets et les petits déjeuners. Le corps en inox 18/10 et l'isolation double paroi sont des gages de qualité et de maintien en température.



Verseuse noire  
**71091P** 60 cl  
**71093P** 130 cl

x 1  
x 1

**P.U.HT**  
**47,50 €**  
**56,50 €**

Verseuse rouge  
**71092P** 60 cl  
**71094P** 130 cl

x 1  
x 1

**P.U.HT**  
**47,50 €**  
**56,50 €**

### Oxygène

Corps inox. Incassable. Isolation par double paroi avec vide d'air. Couvercle avec ouverture à 180°C : entretien aisé.



**71131P** 30 cl  
**71132P** 60 cl  
**71133P** 100 cl

x 1  
x 1  
x 1

**P.U.HT**  
**43,00 €**  
**43,75 €**  
**49,25 €**

## THERMOS

### nouveau !

#### Thermos

En inox. Thermos premium double paroi.



**solia**

**1013619** 75 cl

x 30

**P.U.HT**  
**16,25 €**

## Plateau



GN 1/1  
**69355P** L. 53 x l. 32,5 x H. 4,8 cm x 1 **P.U.HT 34,25 €**

## Cloche



**61532P** Ø 22 cm x 1 **P.U.HT 32,75 €**  
**61533P** Ø 26 cm x 1 **P.U.HT 46,50 €**

## Plat à poisson

Inox 18/0.



**69710P** L. 60 x l. 27 cm x 1 **P.U.HT 16,25 €**

## Plat ovale

Inox 18/0.



**1343P** E L. 46 x l. 30 cm 9/10 personnes x 1 **P.U.HT 10,30 €**  
**1342P** E L. 41 x l. 27 cm 7/8 personnes x 1 **P.U.HT 9,60 €**  
**1341P** E L. 38 x l. 25 cm 5/6 personnes x 1 **P.U.HT 8,40 €**  
**1340P** E L. 34 x l. 22 cm 4 personnes x 1 **P.U.HT 6,50 €**  
**35755** L. 31 x l. 20,5 cm 3 personnes x 1 **P.U.HT 6,90 €**  
**1339** L. 27 x l. 17,5 cm 2 personnes x 1 **P.U.HT 5,70 €**  
**1338** L. 22 x l. 14 cm 1 personne x 1 **P.U.HT 4,60 €**

## Plat rond

Inox 18/0.



**1346P** E Ø 30 cm 6/8 personnes x 1 **P.U.HT 9,80 €**

## Légumier

Inox 18/0.



**1354P** E Ø 24 cm x 1 **P.U.HT 12,40 €**  
**1353** E Ø 22 cm x 12 **P.U.HT 10,60 €**  
**1352P** E Ø 20 cm x 1 **P.U.HT 9,30 €**  
**35761** Ø 16 cm x 1 **P.U.HT 6,40 €**  
**1349** Ø 12 cm x 12 **P.U.HT 4,40 €**

## Plat à gratin ovale

Inox 18/0.



**70092P** E L. 38 x l. 23,5 x H. 4,4 cm x 1 **P.U.HT 16,00 €**  
**67647P** L. 35 x l. 26 x H. 5 cm x 1 **P.U.HT 16,25 €**  
**67646P** E L. 25 x l. 17 x H. 4,3 cm x 1 **P.U.HT 10,50 €**  
**1361** L. 17 x l. 10,5 cm x 1 **P.U.HT 6,00 €**

## Plat à gratin rectangulaire

Inox 18/0.



**31245** E L. 30 x l. 21 x H. 5 cm x 6 **P.U.HT 15,50 €**  
**67644P** E L. 29 x l. 21,5 x H. 5 cm x 1 **P.U.HT 17,50 €**

## Soupière

Inox 18/0.



**1357P** E Ø 24 cm - 4 L x 1 **P.U.HT 16,75 €**  
**1356P** E Ø 22 cm - 3,25 L x 1 **P.U.HT 14,20 €**

## Ramequin

Inox 18/10.



**61531P** E Ø 10,1 cm - 25 cl x 1 **P.U.HT 11,50 €**  
**61530P** E Ø 8,8 cm - 18 cl x 1 **P.U.HT 8,60 €**  
**61529P** E Ø 7,8 cm - 15 cl x 1 **P.U.HT 7,60 €**

## Série Régence

Inox 18/0.



**Plat à poisson 1396** L. 60 x l. 28 cm x 12 **P.U.HT 15,25 €**



**Plat ovale 1394** L. 45 x l. 26,5 cm 9 personnes x 12 **P.U.HT 10,90 €**  
**1392** L. 35 x l. 20 cm 4 personnes x 12 **P.U.HT 7,30 €**  
**1391** L. 30 x l. 16 cm 3 personnes x 12 **P.U.HT 6,10 €**



**Plat rond plat 1403** Ø 33 cm 8/10 personnes x 12 **P.U.HT 11,90 €**



**Légumier 1407** Ø 24 cm x 1 **P.U.HT 7,90 €**  
**1406** Ø 22 cm x 1 **P.U.HT 7,40 €**

## PORCELAINE

### Plat à poisson

En porcelaine blanche.



**1001391** L. 56 x l. 20 cm x 1 **P.U.HT 51,50 €**

### Plat ovale

En porcelaine blanche.



**56456P** E L. 33 x l. 23 cm x 12 **P.U.HT 9,50 €**  
**62094P** E L. 24 x l. 16 cm x 6 **P.U.HT 7,10 €**  
**62095P** E L. 21 x l. 13,5 cm x 6 **P.U.HT 6,20 €**  
**62093P** E L. 17 x l. 10 cm x 12 **P.U.HT 4,60 €**

## Buffet Range

En porcelaine crème. Format gastronomique compatible avec glissières, fours vitrines de tous types.



<b>Plat GN 1/1</b> <b>61484P</b>	L. 53 x l. 32,5 x H. 6,5 cm	x 1	<b>P.U.HT</b> <b>60,50 €</b>
<b>Plat GN 1/2</b> <b>61485P</b>	L. 32,5 x l. 26,5 x H. 6,5 cm	x 2	<b>P.U.HT</b> <b>30,25 €</b>
<b>Plat GN 1/3</b> <b>61486</b>	L. 32,5 x l. 17,6 x H. 6,5 cm	x 3	<b>P.U.HT</b> <b>19,75 €</b>

## Gastronorm

En porcelaine. **Le couvercle sert aussi de plat.** Couleur inaltérable.



<b>Bac GN 1/1 - (53 x 32,5 cm)</b> Prof. 6,5 cm		x 1	<b>P.U.HT</b> <b>45,50 €</b>
<b>1006244</b>	Blanc	x 1	<b>53,00 €</b>
<b>1006254</b>	Noir	x 1	<b>37,25 €</b>
<b>1006250</b>	Bac/couvercle blanc	x 1	<b>48,25 €</b>
<b>1006260</b>	Bac/couvercle noir	x 1	



<b>Bac GN 1/2 - (32,5 x 26,5 cm)</b> Prof. 6,5 cm		x 1	<b>P.U.HT</b> <b>19,75 €</b>
<b>1006245</b>	Blanc	x 1	<b>23,50 €</b>
<b>1006255</b>	Noir	x 2	<b>18,50 €</b>
<b>1006251</b>	Bac/couvercle blanc	x 2	<b>21,75 €</b>
<b>1006261</b>	Bac/couvercle noir	x 2	



<b>Bac GN 1/3 - (32,5 x 17,6 cm)</b> Prof. 6,5 cm		x 1	<b>P.U.HT</b> <b>17,00 €</b>
<b>1006246</b>	Blanc	x 1	<b>20,25 €</b>
<b>1006256</b>	Noir	x 5	<b>15,75 €</b>
<b>1006252</b>	Bac/couvercle blanc	x 5	<b>18,75 €</b>
<b>1006262</b>	Bac/couvercle noir	x 5	



<b>Bac GN 2/3 - (35,4 x 32,5 cm)</b> Prof. 6,5 cm		x 3	<b>P.U.HT</b> <b>32,75 €</b>
<b>1006248</b>	Blanc	x 3	<b>34,25 €</b>
<b>1006259</b>	Noir	x 3	<b>28,00 €</b>
<b>1006253</b>	Bac/couvercle blanc	x 3	<b>32,50 €</b>
<b>1006263</b>	Bac/couvercle noir	x 3	



<b>Bac GN 2/4 - (53 x 16,2 cm)</b> Prof. 6,5 cm		x 1	<b>P.U.HT</b> <b>33,25 €</b>
<b>1006249</b>	Blanc	x 1	<b>35,25 €</b>
<b>1006264</b>	Noir	x 2	<b>28,25 €</b>
<b>1006267</b>	Bac/couvercle blanc	x 2	<b>33,50 €</b>
<b>1006265</b>	Bac/couvercle noir	x 2	



<b>Bac GN 1/4 - (26,1 x 16,3 cm)</b> Prof. 6,5 cm		x 1	<b>P.U.HT</b> <b>12,40 €</b>
<b>1006247</b>	Blanc	x 1	<b>17,00 €</b>
<b>1006257</b>	Noir	x 2	<b>10,80 €</b>
<b>Bac GN 1/6 - (17,2 x 16 cm)</b> Prof. 6,5 cm		x 2	<b>P.U.HT</b> <b>12,80 €</b>
<b>1006266</b>	Blanc	x 2	
<b>1006258</b>	Noir	x 2	



VESTAH

## Bac GN Vestah

En mélamine. Bords renforcés sans Bisphénol A. Pour présentations froides. Ne pas mettre au micro-ondes. Ne pas mettre en contact direct avec la chaleur ou flammes.

**PLATEX**  
1<sup>er</sup> Fabricant Français de Plateaux



**Choisissez votre couleur !**



Gazon Anis



Rubis Cerise



Beige Lumière



Noir

**Choisissez votre taille !**



### Type GN 1/1 (530 x 325 mm)

Réf.	P.U.HT	Réf.	P.U.HT	Réf.	P.U.HT
H. 6,5 cm		H. 3 cm		Plat	
1000208	€ 48,25	1000185	€ 40,25	1000228	€ 35,75 x 6
1000209	€ 48,25	1000186	€ 40,25	1000229	€ 35,75 x 6
1000210	€ 48,25	1000187	€ 40,25	1000230	€ 35,75 x 6
1000211	€ 42,50	1000188	€ 29,50	1000231P	€ 31,75 x 6

### Type GN 1/2 (325 x 265 mm)

Réf.	P.U.HT	Réf.	P.U.HT	Réf.	P.U.HT
H. 6,5 cm		H. 3 cm		Plat	
1000213	€ 31,50	1000190	€ 24,25	1000233	€ 21,75 x 6
1000214	€ 31,50	1000191	€ 24,25	1000234	€ 21,75 x 6
1000215	€ 31,50	1000192	€ 24,25	1000235	€ 21,75 x 6
1000216	€ 27,25	1000193	€ 20,25	1000236P	€ 18,00 x 6

### Type GN 1/3 (325 x 176 mm)

Réf.	P.U.HT	Réf.	P.U.HT	Réf.	P.U.HT
H. 6,5 cm		H. 3 cm		Plat	
1000218	€ 24,50	1000195	€ 19,00	1000238	€ 17,25 x 6
1000219	€ 24,50	1000196	€ 19,00	1000239	€ 17,25 x 6
1000220	€ 24,50	1000197	€ 19,00	1000240	€ 17,25 x 6
1000221	€ 21,00	1000198	€ 15,25	1000241	€ 14,40 x 6

### Type GN 1/4 (265 x 162 mm)

Réf.	P.U.HT	Réf.	P.U.HT
H. 6,5 cm		H. 3 cm	
1000223	€ 17,50	1000247	€ 16,75 x 6
1000224	€ 17,50	1000200	€ 16,75 x 6
1000225	€ 17,50	1000201	€ 16,75 x 6
1000226	€ 14,70	1000246	€ 14,30 x 6

### Type GN 2/4 (530 x 162 mm)

Réf.	P.U.HT	Réf.	P.U.HT
H. 3 cm		Plat	
1000203	€ 16,25	1000243	€ 25,00 x 6
1000204	€ 16,25	1000248	€ 25,00 x 6
1000205	€ 16,25	1000244	€ 25,00 x 6
1000206	€ 10,60	1000245	€ 20,00 x 6





# Bac Eco-Line

En mélamine. Parfait pour toute composition de buffet froid. Léger, résistant aux ébréchantures, empilable. Ne pas poser sur une surface chaude, ni mettre au four ou au micro-ondes.



Bac GN 1/1 - L. 53 x l. 32,5 cm

H. 6,5 cm - 7,1 L  **P.U.HT**  
**1008272P** E Blanc x2 **28,25 €**  
**1008271P** E Noir x2 **28,25 €**



Bac GN 1/4 - L. 26,5 x l. 16,2 cm

H. 6,5 cm - 1,35 L  **P.U.HT**  
**1008264** E Blanc x3 **12,60 €**  
**1008263P** E Noir x3 **12,60 €**



H. 10 cm - 10,6 L  **P.U.HT**  
**1008273** E Blanc x2 **33,25 €**  
**1008279** E Noir x2 **33,25 €**



H. 10 cm - 1,9 L  **P.U.HT**  
**1008277P** E Blanc x3 **14,10 €**  
**1008283P** E Noir x3 **14,10 €**



Bac GN 1/2 - L. 36,5 x l. 26,5 cm

H. 6,5 cm - 3,4 L  **P.U.HT**  
**1008270P** E Blanc x3 **16,00 €**  
**1008269P** E Noir x3 **16,00 €**



Bac GN 1/6 - L. 17,6 x l. 16,2 cm

H. 6,5 cm - 0,8 L  **P.U.HT**  
**1008262** E Blanc x6 **10,10 €**  
**1008261** E Noir x6 **10,10 €**



H. 10 cm - 4,7 L  **P.U.HT**  
**1008274P** E Blanc x3 **19,75 €**  
**1008280P** E Noir x3 **19,75 €**



H. 10 cm - 1 L  **P.U.HT**  
**1008278** E Blanc x6 **10,60 €**  
**1008284P** E Noir x6 **10,60 €**



Bac GN 1/3 - L. 32,5 x l. 17,6 cm

H. 6,5 cm - 2 L  **P.U.HT**  
**1008266P** E Blanc x3 **13,90 €**  
**1008265P** E Noir x3 **13,90 €**



Bac GN 2/4 - L. 53 x l. 16,2 cm

H. 6,5 cm - 3 L  **P.U.HT**  
**1008268** E Blanc x3 **19,25 €**  
**1008267P** E Noir x3 **19,25 €**



H. 10 cm - 2,7 L  **P.U.HT**  
**1008276P** E Blanc x3 **15,75 €**  
**1008282P** E Noir x3 **15,75 €**



H. 10 cm - 4,3 L  **P.U.HT**  
**1008275P** E Blanc x3 **24,25 €**  
**1008281P** E Noir x3 **24,25 €**



## SALADIERS VERRE

## Torcello

En verre sodocalcique.



Saladier

			P.U.HT
64595P	L. 26 x l. 26 x H. 12,5 cm - 265 cl	x 4	13,00 €
64594P	L. 20 x l. 20 x H. 11 cm - 150 cl	x 4	10,10 €
61504P	L. 14 x l. 14 x H. 8 cm - 55 cl	x 6	5,10 €



Coupelle

			P.U.HT
61505P	L. 11 x l. 11 x H. 6 cm - 33 cl	x 6	3,70 €
61506P	L. 8 x l. 8 x H. 6 cm - 11 cl	x 6	2,80 €

## Season's bar

En Zénix.



			P.U.HT
1002196P	Ø 24 x H. 12,4 cm - 220 cl	x 6	12,30 €
1002198P	Ø 20 x H. 9,9 cm - 100 cl	x 4	6,00 €
1002199P	Ø 17 x H. 8,3 cm - 70 cl	x 12	4,30 €

## Stella



			P.U.HT
67728P	L. 15,5 x l. 15,5 x H. 5,5 cm	x 6	5,10 €

## Cocoon

En verre trempé.



			P.U.HT
60638P	E Ø 28 cm - 550 cl	x 4	7,00 €
60637P	E Ø 24 cm - 360 cl	x 4	4,60 €
60635P	E Ø 18 cm - 150 cl	x 6	3,00 €
60634P	E Ø 15 cm - 86,5 cl	x 4	2,70 €
60633P	E Ø 12 cm - 41 cl	x 6	1,10 €
60631P	E Ø 6 cm - 4,5 cl	x 6	0,65 €

## Verre

En verre trempé très résistant.



			P.U.HT
621P	E Ø 26 cm - 430 cl	x 6	3,60 €
620P	E Ø 23 cm - 290 cl	x 6	2,30 €
41791P	Ø 20 cm - 180 cl	x 6	2,00 €
41790P	Ø 14 cm - 62 cl	x 6	0,98 €
33073P	Ø 12 cm - 38 cl	x 6	0,92 €
69588P	E Ø 7,5 cm - 6 cl	x 12	0,89 €
69587P	Ø 6 cm - 3,5 cl	x 12	0,61 €

## Picardie

En verre trempé.



			P.U.HT
1011237P	E Ø 15 cm - 63,5 cl	x 6	1,50 €

## Oséo

En verre sodocalcique.



			P.U.HT
1005491P	E L. 11 x l. 11 x H. 9,3 cm - 39,7 cl	x 6	2,10 €

## Papaya

En verre sodocalcique.



			P.U.HT
69204P	L. 40 cm	x 4	20,00 €



FRIDA

nouveau !

**Frida**

En mélamine. Intérieur imitation bois.



Blanc / bambou

**1013601P** L. 25 x l. 25 x H. 7,5 cm x 6 **P.U.HT 14,30 €**  
**1013527P** L. 16,5 x l. 16,5 x H. 5,5 cm x 1 **7,70 €**



Noir / bambou

**1013602P** L. 25 x l. 25 x H. 7,5 cm x 6 **P.U.HT 14,30 €**  
**1013526P** L. 16,5 x l. 16,5 x H. 5,5 cm x 1 **7,70 €**



Blanc / bambou

**1013529P** L. 17,6 x l. 10,8 x H. 5,5 cm x 1 **P.U.HT 8,30 €**



Noir / bambou

**1013528P** L. 17,6 x l. 10,8 x H. 5,5 cm x 1 **P.U.HT 8,30 €**



Blanc / bambou

**1013603** L. 53 x l. 16,2 x H. 7,5 cm x 6 **P.U.HT 24,25 €**

Noir / bambou

**1013604** L. 53 x l. 16,2 x H. 7,5 cm x 6 **P.U.HT 24,25 €**

**Vestah**

En mélamine.



Saladier Beige / Lumière

**68758P** E Ø 25 x H. 17 cm - 4 L x 4 **P.U.HT 25,25 €**  
**1000252** E Ø 30 x H. 17 cm - 5 L x 4 **34,25 €**



Saladier Gazon Anis

**1000249P** E Ø 25 x H. 17 cm - 4 L x 4 **P.U.HT 25,25 €**  
**1000253P** E Ø 30 x H. 17 cm - 5 L x 4 **34,25 €**



Saladier Rubis Cerise

**1000250P** E Ø 25 x H. 17 cm - 4 L x 4 **P.U.HT 25,25 €**  
**1000254P** E Ø 30 x H. 17 cm - 5 L x 4 **34,25 €**



Légumier Beige Lumière

**1000256** E Ø 22 cm x 6 **P.U.HT 8,30 €**  
**68755P** E Ø 26 cm x 6 **12,40 €**



Légumier Anis

**1000257P** E Ø 22 cm x 6 **P.U.HT 8,20 €**  
**1000260P** E Ø 26 cm x 6 **12,40 €**



Légumier Rubis

**1000258** E Ø 22 cm x 6 **P.U.HT 8,20 €**  
**1000261P** E Ø 26 cm x 6 **12,40 €**



**Float**

En mélamine. Léger et empilable. Parfait pour toute composition de buffet froid. Pieds anti-dérapant.



<b>Saladier rond blanc</b>		<b>P.U.HT</b>
<b>1008242P</b> E Ø 20 cm - 2 L	x 2	<b>16,00 €</b>
<b>1008246</b> Ø 13 cm - 0,45 L	x 6	<b>6,40 €</b>



<b>Saladier rond noir</b>		<b>P.U.HT</b>
<b>1008243P</b> E Ø 20 cm - 2 L	x 2	<b>16,00 €</b>
<b>1008245</b> Ø 15 cm - 0,7 L	x 8	<b>9,30 €</b>
<b>1008247</b> Ø 13 cm - 0,45 L	x 6	<b>6,40 €</b>



<b>Saladier carré blanc</b>		<b>P.U.HT</b>
<b>1008236P</b> E L. 25,5 x l. 25,5 cm - 4 L	x 2	<b>26,25 €</b>
<b>1008238P</b> E L. 19,5 x l. 19,5 cm - 1,5 L	x 4	<b>14,30 €</b>
<b>1008240P</b> L. 12,5 x l. 12,5 cm - 0,5 L	x 6	<b>6,10 €</b>



<b>Saladier carré noir</b>		<b>P.U.HT</b>
<b>1008237P</b> E L. 25,5 x l. 25,5 cm - 4 L	x 2	<b>26,25 €</b>
<b>1008239P</b> E L. 19,5 x l. 19,5 cm - 1,5 L	x 4	<b>14,30 €</b>
<b>1008241P</b> L. 12,5 x l. 12,5 cm - 0,5 L	x 6	<b>6,10 €</b>

En SAN. Dispose d'une encoche pour une louche. Permet un empilage parfait des contenants pleins.



<b>Couvercle transparent</b>		<b>P.U.HT</b>
<b>1008250P</b> E Ø 20,5 cm	x 1	<b>8,30 €</b>



<b>Couvercle transparent</b>		<b>P.U.HT</b>
<b>1008249P</b> E L. 19 x l. 19 cm	x 1	<b>8,30 €</b>
<b>1008248P</b> E L. 25 x l. 25 cm	x 1	<b>10,50 €</b>

En métal chromé. Présentoir pour 3 saladiers Float 19,5 x 19,5 cm. Pieds anti-dérapants.



<b>Présentoir</b>		<b>P.U.HT</b>
<b>1008251</b> L. 55,5 x l. 19 x H. 15,5 cm	x 2	<b>37,25 €</b>

**KING**



**Saladier Balance**



En mélamine. Pieds anti-dérapant. Ne pas mettre en relation directe avec une source de chaleur. Ne pas passer au micro-ondes ou au four.



<b>Blanc</b>		<b>P.U.HT</b>
<b>1008229P</b> Ø 30 x H. 19,5 cm - 5 L	x 6	<b>25,25 €</b>
<b>1008231P</b> E Ø 24,5 x H. 15 cm - 2,5 L	x 8	<b>15,25 €</b>
<b>1008233P</b> Ø 21 x H. 13 cm - 1,5 L	x 10	<b>11,60 €</b>
<b>1008235</b> Ø 14,5 x H. 9 cm - 0,4 L	x 10	<b>5,30 €</b>



<b>Noir</b>		<b>P.U.HT</b>
<b>1008228P</b> Ø 30 x H. 19,5 cm - 5 L	x 6	<b>25,25 €</b>
<b>1008230P</b> E Ø 24,5 x H. 15 cm - 2,5 L	x 8	<b>15,25 €</b>
<b>1008232</b> Ø 21 x H. 13 cm - 1,5 L	x 10	<b>11,60 €</b>
<b>1008234</b> Ø 14,5 x H. 9 cm - 0,4 L	x 10	<b>5,30 €</b>



**Présentoir King**



En métal chromé. Pour tous types de saladiers. Anti-glisse : revêtement anti-dérapant sur les extrémités des 3 pieds et sur la base.



		<b>P.U.HT</b>
<b>1008252</b> E Ø 15 x H. 21 cm	x 3	<b>40,00 €</b>
<b>1008253P</b> E Ø 15 x H. 14 cm	x 3	<b>36,25 €</b>

## MÉLAMINE

### Wave

En mélamine. Mat à l'extérieur et brillant à l'intérieur.



Blanc			P.U.HT
1011784	Ø 26 cm - 3,85 L	x 4	25,00 €
1011783	Ø 23 cm - 3 L	x 6	17,50 €



Noir / blanc			P.U.HT
1011790	Ø 26 cm - 3,85 L	x 4	25,00 €
1011789	Ø 23 cm - 3 L	x 6	17,50 €

## DOUBLE PAROI

Construction à double paroi : La double paroi permet de maintenir des aliments, chauds ou froids, à la bonne température durant un service. Pas de condensation sur les parois. Lavable au lave-vaisselle.



### Saladier conique

Saladier isotherme à double paroi en inox.



			P.U.HT
60017P	E Ø 24 cm - 2,4 L	x 1	60,00 €
60016P	E Ø 20 cm - 1,3 L	x 1	45,50 €
60015P	E Ø 16 cm - 0,59 L	x 1	36,50 €

### Saladier double paroi



Saladier isotherme à double paroi en inox. Intérieur poli miroir, extérieur satiné.



			P.U.HT
1002113P	E Ø 30 cm - 3,5 L	x 1	40,00 €
1002112P	E Ø 24,5 cm - 2,4 L	x 1	30,75 €
1002111P	Ø 19,5 cm - 1 L	x 1	21,50 €
1002110P	E Ø 15 cm - 0,6 L	x 1	17,00 €

## COPOLYESTER

### Saladier copolyester

Translucide. Sans bisphénol A.



Gris anthracite / blanc			P.U.HT
1011796	Ø 26 cm - 3,85 L	x 4	25,00 €
1011795	Ø 23 cm - 3 L	x 6	17,50 €



			P.U.HT
41788P	E Ø 31 cm - 7,5 L	x 1	15,25 €
41787P	E Ø 27 cm - 5 L	x 1	11,60 €
41786P	E Ø 23 cm - 3,5 L	x 1	8,10 €
41785P	E Ø 20 cm - 2 L	x 1	7,10 €

## PORCELAINE

### Fine dine

En porcelaine crème extra résistante.



Saladier rond			P.U.HT
59265P	Ø 23 cm - 1,4 L	x 12	13,60 €



Saladier ovale			P.U.HT
59268P	L. 27 x l. 19 cm	x 6	22,00 €
59267P	L. 24 x l. 16 cm	x 6	18,00 €
59266P	L. 16 x l. 11 cm	x 6	12,70 €

### Banquet

En porcelaine crème extra résistante.



			P.U.HT
59213P	Ø 31 cm - 5,9 L	x 1	17,25 €
59212P	E Ø 25 cm - 2 L	x 1	9,80 €
59211P	Ø 20 cm - 1,05 L	x 12	4,70 €
59210P	Ø 16 cm - 0,67 L	x 12	3,80 €
63623P	Ø 14 cm - 0,5 L	x 12	3,60 €
63622P	Ø 12 cm - 0,31 L	x 12	3,40 €

**Bar à sauces**

Bouton poussoir. Base et récipients en plexiglas, couvercles en inox. Réglage précis des doses : de 25 à 40 g.



			P.U. HT
48416P	3 x 165 cl	x 1	295,00 €
48417P	Récipient seul 165 cl	x 1	18,75 €

**Distributeur à sauce**

Inox.



			P.U. HT
40465	350 cl	x 1	269,00 €
40466	550 cl	x 1	285,00 €

**Distributeur Invertatop**

Polyéthylène. Souple. Identification des contenus par les bouchons de couleurs disponibles en option. Parfait pour le service des huiles, vinaigres ou sauces plus épaisses comme mayonnaises. Ouverture des 2 côtés pour un nettoyage facile.



			P.U. HT
A 1011258P	Translucide - 35 cl	x 6	2,40 €
B 1011259P	Paquet de 12 bouchons (2 x 6 couleurs)	x 1	4,40 €

**Distributeur individuel pressable**

Bouteille souple en polyéthylène translucide, avec bouchon à vis et une ouverture large pour un remplissage aisé.



			P.U. HT
Lot de 4			
1003326P	70 cl	x 1	11,00 €
66015P	35 cl	x 1	9,20 €
1003327P	25 cl	x 1	7,40 €

**Cuillère**

Nylon. Construction d'une pièce extrêmement durable et résistant à 246°C. L. 33,7 cm.



			P.U. HT
Cuillère perforée			
1006359P	E Noir	x 1	4,70 €
1006360P	E Blanc	x 1	4,70 €



			P.U. HT
Cuillère pleine			
1006361P	E Noir	x 1	4,70 €
1006358P	E Blanc	x 1	4,70 €

**Louchette**

Méla mine.

Dalebrook



			P.U. HT
1006240P	E L. 30 cm - 2,8 cl - Noir	x 1	3,70 €
1006238P	E L. 21,7 cm - 1,7 cl - Noir	x 1	3,30 €
1006239P	E L. 30 cm - 2,8 cl - Blanc	x 1	3,70 €
1006237P	E L. 21,7 cm - 1,7 cl - Blanc	x 1	3,30 €

**Pince feuille de chêne**

Acétal. Idéale pour servir des aliments froids et chauds, jusqu'à 100°C.

CAMBRO  
TRUSTED FOR GENERATIONS



			P.U. HT
63347P	L. 30,5 cm - Noir	x 1	5,60 €
63345P	L. 23 cm - Noir	x 1	3,80 €
1006614P	L. 23 cm - Blanc	x 1	3,80 €

**1<sup>er</sup> PRIX Pince**

Inox.



			P.U. HT
1030P	E L. 40 cm	x 1	7,40 €
1029P	E L. 23 cm	x 1	3,60 €

**Pince anti-microbien**

Utilisez le pouvoir de la technologie antimicrobienne aux ions argent Agion®, une exclusivité Vollrath. Alors que les surfaces non traitées permettent aux microbes de se rassembler et de se multiplier, les ions argent des ustensiles antimicrobiens de Vollrath les attaquent !



			P.U. HT
1006368P	E L. 30,5 cm - Noir	x 1	8,80 €
1006367P	L. 24 cm - Noir	x 1	8,30 €
1006364P	E L. 15 cm - Noir	x 1	6,40 €
65462P	E L. 24 cm - Rouge	x 1	8,10 €
1006365P	E L. 15 cm - Rouge	x 1	6,40 €
65463P	E L. 24 cm - Jaune	x 1	8,30 €
1006363P	E L. 15 cm - Jaune	x 1	6,40 €
65464P	E L. 24 cm - Vert	x 1	8,30 €
1006366P	E L. 15 cm - Vert	x 1	6,40 €
65461P	E L. 24 cm - Bleu	x 1	8,10 €
1006362P	E L. 15 cm - Bleu	x 1	6,40 €

**1<sup>er</sup> PRIX Pince**

En acier inoxydable avec manche plastique de couleur.



			P.U. HT
L. 25 cm			
71182P	E Bleu	x 1	7,80 €
71183P	E Verte	x 1	7,80 €
71184P	E Marron	x 1	7,80 €
71185P	E Rouge	x 1	7,80 €

**Pince feuille de chêne**

Inox. Embout nylon. Ne raye pas les plats et atténue le bruit. Résiste à 210°C.

Lacor



			P.U. HT
57248P	L. 40,5 cm	x 1	7,50 €
57730P	L. 30 cm	x 1	5,90 €

## Gamme buffet

Inox. Poli miroir. Manipulation facilitée grâce à la bonne prise en main.

Gamme Stop'Glisse voir page 438



Pince multi-usages  
 63093 L. 31 cm x6 P.U.HT 11,80 €



Pelle à tarte  
 63094 L. 27 cm x1 P.U.HT 9,40 €



Louche  
 63092 L. 31 cm x6 P.U.HT 16,25 €



Cuillère à spaghetti  
 62697 L. 31 cm x6 P.U.HT 16,25 €



Louchette  
 63095 L. 26 cm x6 P.U.HT 13,80 €



Cuillère à spaghetti  
 57741P L. 34 cm x1 P.U.HT 12,70 €



Cuillère à servir  
 62695 L. 31 cm x6 P.U.HT 10,50 €



Louche à sauce 5 cl  
 57244P E L. 28,5 cm x1 P.U.HT 9,70 €



Cuillère de service  
 62696 L. 32 cm x6 P.U.HT 11,10 €



Louche à sauce 15 cl  
 57736P L. 37 cm x1 P.U.HT 12,10 €



Cuillère à salade  
 63090 L. 30 cm x6 P.U.HT 10,10 €



Cuillère pleine  
 57739P L. 36 cm x1 P.U.HT 8,80 €



Fourchette à servir  
 63091 L. 30 cm x6 P.U.HT 10,10 €



Cuillère perforée  
 57740P L. 35,5 cm x1 P.U.HT 9,20 €



Cuillère à sauce  
 62694 L. 21 cm x6 P.U.HT 11,20 €



Ecumoire  
 57733P L. 36 cm x1 P.U.HT 13,70 €

## Pince de luxe



Inox.



57734P L. 30 cm x1 P.U.HT 10,60 €

## Pince à salade



Inox.



57731P E L. 25 cm x1 P.U.HT 14,40 €

## Pince multi-usages

Inox.



1005084P L. 24 cm x1 P.U.HT 13,50 €

## Pince à servir

Inox.



67690P A - L. 21 cm x1 P.U.HT 6,70 €  
 1001426P B - L. 19 cm x1 P.U.HT 12,20 €

## Pince à spaghetti

Inox.



1005085P E L. 29 cm x1 P.U.HT 32,75 €  
 67688P E L. 19 cm x1 P.U.HT 4,40 €

## Pince à pain

Inox.



1001425P L. 23 cm x1 P.U.HT 9,00 €

## Pince à gâteaux

Inox.



1001424P L. 20 cm x1 P.U.HT 15,00 €

## Nappe Jara

Nappage textile doux. Lavage à 60°C. Autres couleurs, nous consulter.



Blanc - 60 % polyester, 40 % lin.  
Épaisseur 220 g/m<sup>2</sup>.

			P.U.HT
<b>1006283</b>	80 x 80 cm	x 6	<b>22,00 €</b>
<b>1006285</b>	130 x 130 cm	x 6	<b>48,00 €</b>
<b>1006284</b>	170 x 130 cm	x 6	<b>56,50 €</b>

## Nappe Saten

Nappe textile doux. Lavage à 40 °C. Autres coloris, nous consulter.

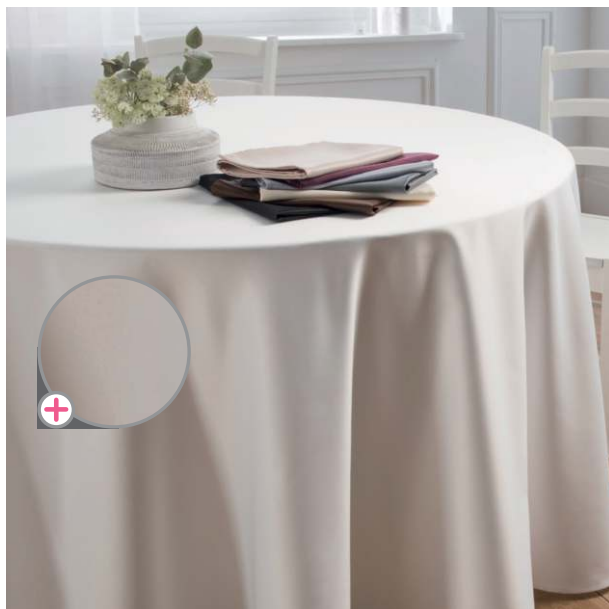

Blanc - 50% coton, 50 % polyester.  
Épaisseur 247 g/m<sup>2</sup>.

			P.U.HT
<b>1006292</b>	80 x 80 cm	x 6	<b>14,40 €</b>
<b>1006294</b>	130 x 130 cm	x 6	<b>30,00 €</b>
<b>1006293</b>	170 x 130 cm	x 6	<b>37,25 €</b>

Blanc - 100 % polyester.  
Épaisseur 220 g/m<sup>2</sup>.

			P.U.HT
<b>1006289</b>	80 x 80 cm	x 6	<b>12,90 €</b>
<b>1006291</b>	130 x 130 cm	x 6	<b>25,00 €</b>
<b>1006290</b>	170 x 130 cm	x 6	<b>31,25 €</b>

## Nappe Opal

Nappage textile doux. Lavage à 60°. Autres couleurs, nous consulter.



Blanc - 50 % coton, 50 % polyester.  
Épaisseur 280 g/m<sup>2</sup>.

			P.U.HT
<b>1006286</b>	80 x 80 cm	x 6	<b>19,50 €</b>
<b>1006288</b>	130 x 130 cm	x 6	<b>34,00 €</b>
<b>1006287</b>	170 x 130 cm	x 6	<b>42,75 €</b>

## 1<sup>er</sup> PRIX

### Nappe Rota

Nappage entretien et repassage très facile, idéal pour l'hôtellerie. Entretien facile. Pour le blanc : lavage à 60 °C maxi. Ne pas utiliser d'eau de javel. Ne pas utiliser de chlore. Repassage facile : température maxi 110°.

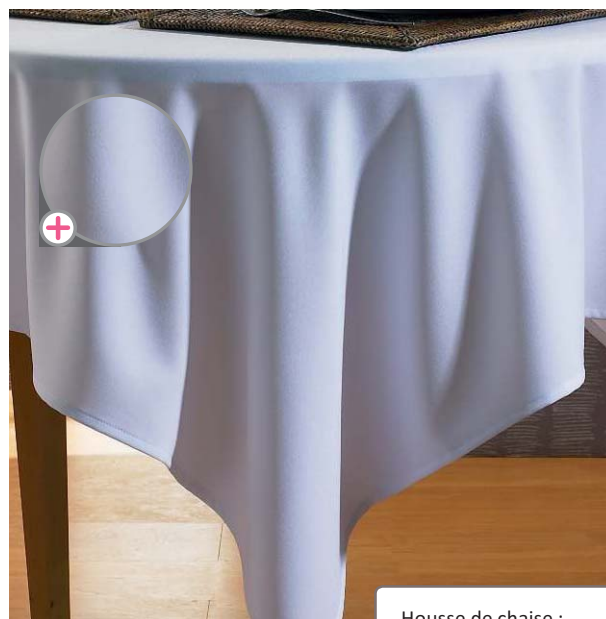

Housse de chaise :  
nous consulter



Blanc - 100 % polyester.  
Épaisseur 110 g/m<sup>2</sup>.

			P.U.HT
<b>63159</b>	80 x 80 cm	x 5	<b>11,50 €</b>
<b>63161</b>	130 x 130 cm	x 5	<b>14,60 €</b>
<b>63162</b>	130 x 170 cm	x 5	<b>16,25 €</b>





## Nappe Capris

CANDOLA  
Créateurs d'Ambiance

Tissu damassé avec un relief satiné. Entretien facile, traitement déperlant à essuyer simplement avec un papier absorbant. Moins de repassage, ne rétrécit pas.



Blanc - 100 % polyester.  
Épaisseur 300 g/m<sup>2</sup>.

<b>1006591</b>	80 x 80 cm
<b>1006589</b>	130 x 130 cm
<b>1006590</b>	170 x 130 cm



x 1  
x 1  
x 1

**P.U.HT**

**27,00 €**  
**68,50 €**  
**72,50 €**

## Nappe Leinen

CANDOLA  
Créateurs d'Ambiance

Leinen est un tissu en structure lin. Entretien facile, traitement déperlant à essuyer simplement avec un papier absorbant. Moins de repassage, ne rétrécit pas.

Autres couleurs, nous consulter.



Blanc - 100 % polyester.  
Épaisseur 250 g/m<sup>2</sup>.

<b>1006594</b>	80 x 80 cm
<b>1006592</b>	130 x 130 cm
<b>1006593</b>	170 x 130 cm



x 1  
x 1  
x 1

**P.U.HT**

**21,00 €**  
**54,50 €**  
**66,00 €**

## Nappe Sara matt

CANDOLA  
Créateurs d'Ambiance

Sara est un tissu satiné mat classique. Entretien facile. Traitement déperlant à essuyer simplement avec un papier absorbant. Moins de repassage, ne rétrécit pas. Autres couleurs, nous consulter.



Blanc 1000 - 100 % polyester.  
Épaisseur 245 g/m<sup>2</sup>.

<b>1006598</b>	80 x 80 cm
<b>1006599</b>	130 x 130 cm
<b>1006600</b>	170 x 130 cm



x 1  
x 1  
x 1

**P.U.HT**

**20,75 €**  
**50,50 €**  
**66,50 €**

## Nappe Qadro

CANDOLA  
Créateurs d'Ambiance

Qadro est un tissu carreau style "vichy". Entretien facile, traitement déperlant à essuyer simplement avec un papier absorbant. Moins de repassage, ne rétrécit pas. Autres couleurs, nous consulter.

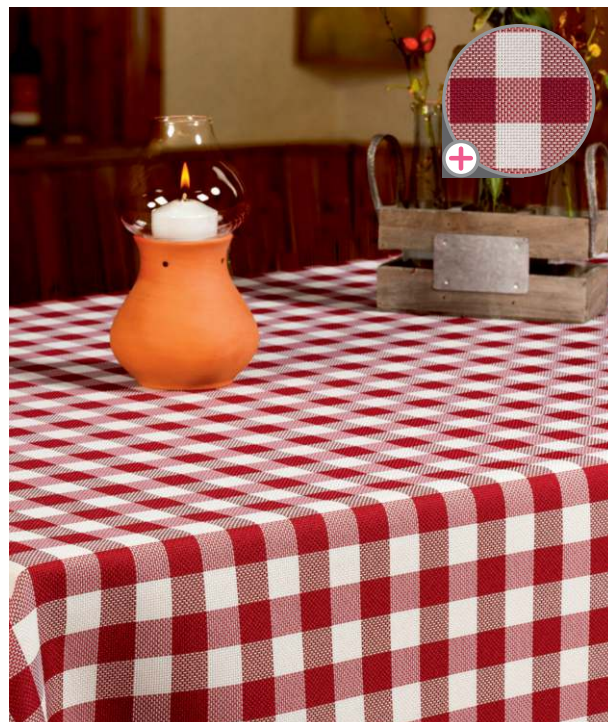

Rouge 3336 - 100 % polyester.  
Épaisseur 195 g/m<sup>2</sup>.

<b>1006595</b>	80 x 80 cm
<b>1006596</b>	130 x 130 cm
<b>1006597</b>	170 x 130 cm



x 1  
x 1  
x 1

**P.U.HT**

**20,25 €**  
**49,25 €**  
**65,00 €**





nouveau !



## Sonoclass

100 % polyester. Epaisseur 220 g/m<sup>2</sup>. Grande largeur.  
Aspect jacquard satiné.



Blanc			P.U.HT
<b>1013566</b>	Ø 140 cm	x1	<b>74,50 €</b>
<b>1013569</b>	Ø 180 cm	x1	<b>88,50 €</b>
<b>1013572</b>	Ø 230 cm	x1	<b>107,00 €</b>
<b>1013560</b>	L. 180 x l. 180 cm	x1	<b>78,50 €</b>
<b>1013563</b>	L. 230 x l. 230 cm	x1	<b>97,00 €</b>
<b>1013575</b>	Serviette L. 45 x l. 45 cm	x5	<b>6,20 €</b>
Gris			P.U.HT
<b>1013568</b>	Ø 140 cm	x1	<b>74,50 €</b>
<b>1013571</b>	Ø 180 cm	x1	<b>88,50 €</b>
<b>1013574</b>	Ø 230 cm	x1	<b>107,00 €</b>
<b>1013562</b>	L. 180 x l. 180 cm	x1	<b>78,50 €</b>
<b>1013565</b>	L. 230 x l. 230 cm	x1	<b>97,00 €</b>
<b>1013577</b>	Serviette L. 45 x l. 45 cm	x5	<b>6,20 €</b>
Beige			P.U.HT
<b>1013567</b>	Ø 140 cm	x1	<b>74,50 €</b>
<b>1013570</b>	Ø 180 cm	x1	<b>88,50 €</b>
<b>1013573</b>	Ø 230 cm	x1	<b>107,00 €</b>
<b>1013561</b>	L. 180 x l. 180 cm	x1	<b>78,50 €</b>
<b>1013564</b>	L. 230 x l. 230 cm	x1	<b>97,00 €</b>
<b>1013576</b>	Serviette L. 45 x l. 45 cm	x5	<b>6,20 €</b>

## Fleur de Lys

Nappage textile 100% polyester damassé. Lavage 40°.



Blanc			P.U.HT
<b>1006432</b>	L. 80 x 80 cm	x3	<b>27,00 €</b>
<b>1006433</b>	L. 130 x 130 cm	x2	<b>41,75 €</b>
<b>1006434</b>	L. 170 x 130 cm	x2	<b>54,00 €</b>

## Nappe Skailys

100 % polyester. Epaisseur 245g/m<sup>2</sup>. Nappage effet croute de cuir épaisse grainée.  
Nettoyage en machine à 30° une à deux fois par an. Repassage à l'envers.

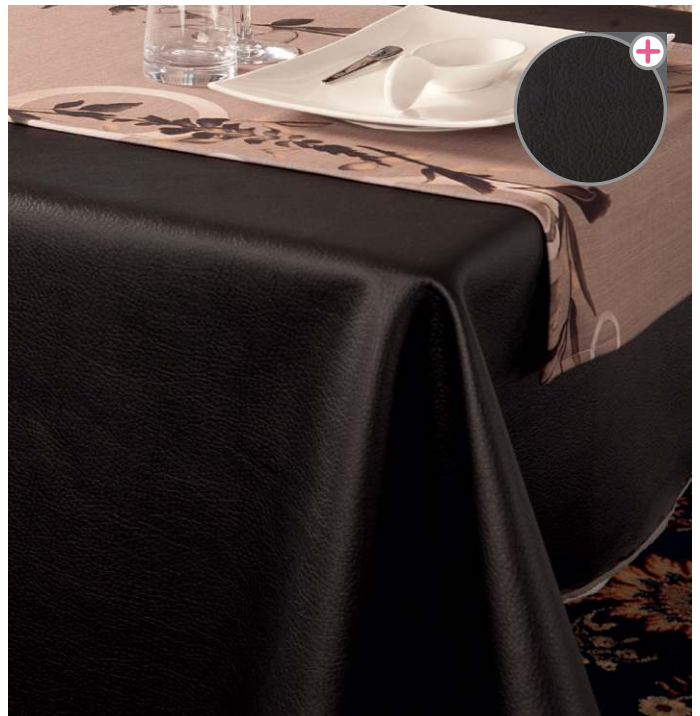

Noir			P.U.HT
<b>1003565</b>	L. 70 x l. 70 cm	x6	<b>25,00 €</b>
<b>1003569</b>	L. 130 x l. 130 cm	x2	<b>55,00 €</b>
<b>1003573</b>	L. 180 x l. 130 cm	x2	<b>70,50 €</b>

## Nappe Linelys



Aspect lin naturel. 100 % polyester. Epaisseur 220 g/m<sup>2</sup>. Entretien facile. Repassage superflu. Antitâche déperlant. Lavage 40°C. Asperger les taches de gras avant lavage. Autres coloris, nous consulter.



Blanc			P.U.HT
<b>1001088</b>	70 x 70 cm	x 6	<b>22,00 €</b>
<b>1001106</b>	130 x 130 cm	x 2	<b>46,50 €</b>
<b>1001124</b>	130 x 180 cm	x 2	<b>56,00 €</b>

Autres coloris,  
nous consulter



## Nappe Magilys



Maille très résistante, lisse et satinée. 100 % polyester. Epaisseur 220 g/m<sup>2</sup>. Infroissable. Sèche en 10 minutes à même la table.

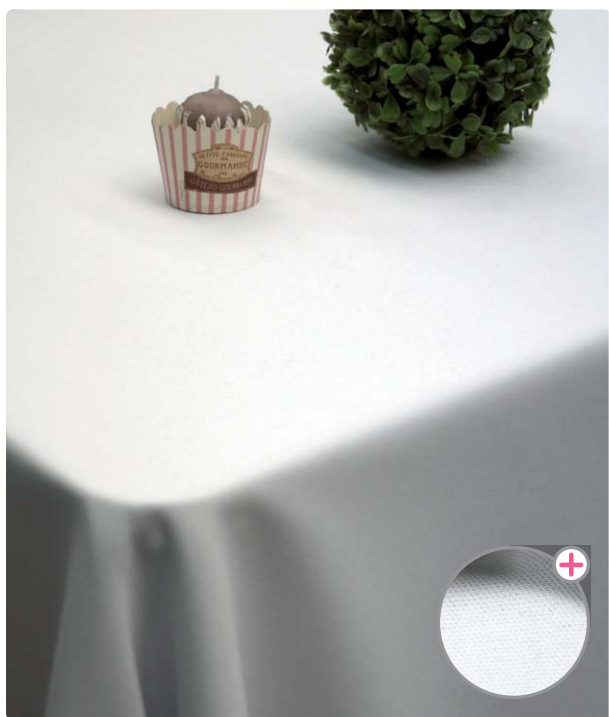

Blanc			P.U.HT
<b>1006435</b>	80 x 80 cm	x 1	<b>32,25 €</b>
<b>1006436</b>	130 x 130 cm	x 1	<b>39,50 €</b>
<b>1006438</b>	170 x 130 cm	x 1	<b>53,00 €</b>

Infroissable



## Nappe Antiglys



Maille antidérapante, adhère à la table grâce à sa maille caoutchoutée. 100 % polyester. Epaisseur 330 g/m<sup>2</sup>. Anti-tâches grâce à son traitement déperlant. Lavage à 40°C.

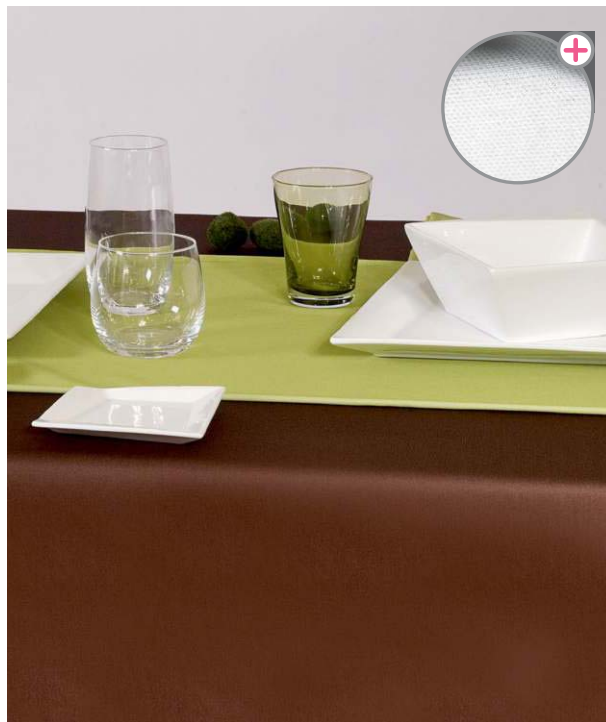

Blanc			P.U.HT
<b>1006439</b>	80 x 80 cm	x 1	<b>39,75 €</b>
<b>1006431</b>	130 x 130 cm	x 1	<b>55,00 €</b>
<b>1006437</b>	130 x 170 cm	x 1	<b>66,00 €</b>

Maille  
antidérapante



## Nappe Demilys



En polycoton. 240 g/m<sup>2</sup>. Nappage avec un bel aspect coton sobre et raffiné. Entretien facile avec un léger repassage. Faire un premier lavage à froid avant l'utilisation. Lavage à 40°C, repassage moyen, retrait 3 % après lavage.

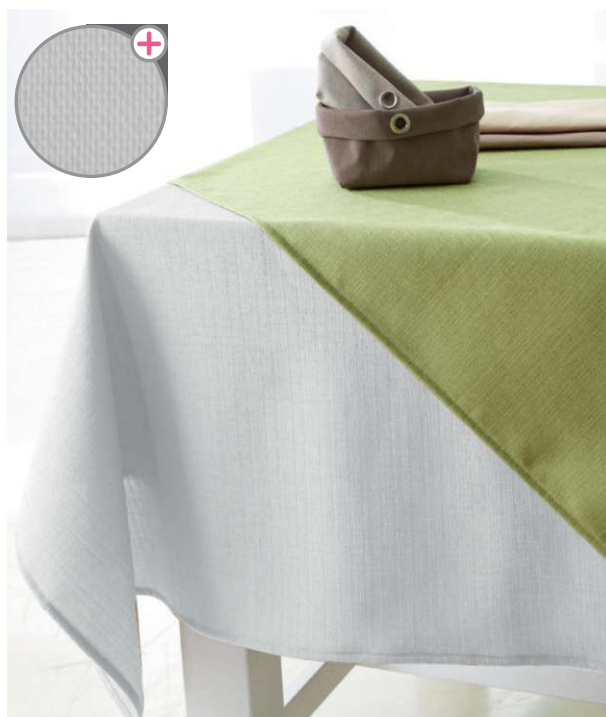

Blanc			P.U.HT
<b>1003448</b>	70 x 70 cm	x 6	<b>21,25 €</b>
<b>1003460</b>	130 x 130 cm	x 2	<b>39,75 €</b>
<b>1003472</b>	180 x 130 cm	x 2	<b>49,75 €</b>
<b>1003484</b>	Serviette 45 x 45 cm	x 12	<b>6,80 €</b>

Toucher  
vrai coton



# Sonoclean

100 % polyester PVC. 300 g/m<sup>2</sup>. Facile d'entretien, imperméable, lavable à l'éponge.



SONOLYS

## Nappage Tiss



<b>Nappe anis</b>			
<b>1010066</b>	L. 70 x l. 70 cm	x 1	<b>37,50 €</b>
<b>1010072</b>	L. 130 x l. 130 cm	x 1	<b>58,00 €</b>
<b>1010078</b>	L. 130 x l. 180 cm	x 1	<b>74,50 €</b>
<b>Tête à tête anis</b>			
<b>1010122</b>	L. 43 x l. 120 cm	x 3	<b>20,25 €</b>

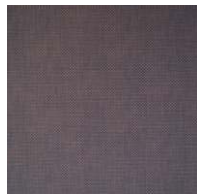

<b>Nappe chocolat</b>			
<b>1010068</b>	L. 70 x l. 70 cm	x 1	<b>37,50 €</b>
<b>1010074</b>	L. 130 x l. 130 cm	x 1	<b>58,00 €</b>
<b>1010080</b>	L. 130 x l. 180 cm	x 1	<b>74,50 €</b>
<b>Tête à tête chocolat</b>			
<b>1010124</b>	L. 43 x l. 120 cm	x 3	<b>20,25 €</b>



<b>Nappe gris</b>			
<b>1010069</b>	L. 70 x l. 70 cm	x 1	<b>37,50 €</b>
<b>1010075</b>	L. 130 x l. 130 cm	x 1	<b>58,00 €</b>
<b>1010081</b>	L. 130 x l. 180 cm	x 1	<b>74,50 €</b>
<b>Tête à tête Tiss gris</b>			
<b>1010125</b>	L. 43 x l. 120 cm	x 3	<b>20,25 €</b>



<b>Nappe rouge</b>			
<b>1010070</b>	L. 70 x l. 70 cm	x 1	<b>37,50 €</b>
<b>1010076</b>	L. 130 x l. 130 cm	x 1	<b>58,00 €</b>
<b>1010082</b>	L. 130 x l. 180 cm	x 1	<b>74,50 €</b>
<b>Tête à tête rouge</b>			
<b>1010126</b>	L. 43 x l. 120 cm	x 3	<b>20,25 €</b>



<b>Nappe taupe</b>			
<b>1010071</b>	L. 70 x l. 70 cm	x 1	<b>37,50 €</b>
<b>1010077</b>	L. 130 x l. 130 cm	x 1	<b>58,00 €</b>
<b>1010083</b>	L. 130 x l. 180 cm	x 1	<b>74,50 €</b>
<b>Tête à tête taupe</b>			
<b>1010127</b>	L. 43 x l. 120 cm	x 3	<b>20,25 €</b>

## Nappage Carreaux



<b>Nappe rouge/beige</b>			
<b>1010084</b>	L. 70 x l. 70 cm	x 1	<b>37,50 €</b>
<b>1010086</b>	L. 130 x l. 130 cm	x 1	<b>58,00 €</b>
<b>1010088</b>	L. 130 x l. 180 cm	x 1	<b>74,50 €</b>
<b>Tête à tête rouge/beige</b>			
<b>1010120</b>	L. 43 x l. 120 cm	x 3	<b>20,25 €</b>

## Nappage Vache



<b>Nappe</b>			
<b>1010099</b>	L. 70 x l. 70 cm	x 1	<b>37,50 €</b>
<b>1010100</b>	L. 130 x l. 130 cm	x 1	<b>58,00 €</b>
<b>1010101</b>	L. 130 x l. 180 cm	x 1	<b>74,50 €</b>
<b>Tête à tête</b>			
<b>1010131</b>	L. 43 x l. 120 cm	x 3	<b>20,25 €</b>

## Nappage Jean



<b>Nappe beige</b>			
<b>1010090</b>	L. 70 x l. 70 cm	x 1	<b>37,50 €</b>
<b>1010096</b>	L. 130 x l. 130 cm	x 1	<b>58,00 €</b>
<b>1010093</b>	L. 130 x l. 180 cm	x 1	<b>74,50 €</b>
<b>Tête à tête beige</b>			
<b>1010128</b>	L. 43 x l. 120 cm	x 3	<b>20,25 €</b>



<b>Nappe bleu</b>			
<b>1010091</b>	L. 70 x l. 70 cm	x 1	<b>37,50 €</b>
<b>1010097</b>	L. 130 x l. 130 cm	x 1	<b>58,00 €</b>
<b>1010094</b>	L. 130 x l. 180 cm	x 1	<b>74,50 €</b>
<b>Tête à tête bleu</b>			
<b>1010129</b>	L. 43 x l. 120 cm	x 3	<b>20,25 €</b>



<b>Nappe gris</b>			
<b>1010092</b>	L. 70 x l. 70 cm	x 1	<b>37,50 €</b>
<b>1010098</b>	L. 130 x l. 130 cm	x 1	<b>58,00 €</b>
<b>1010095</b>	L. 130 x l. 180 cm	x 1	<b>74,50 €</b>
<b>Tête à tête gris</b>			
<b>1010130</b>	L. 43 x l. 120 cm	x 3	<b>20,25 €</b>

## Nappage Vintage



<b>Nappe ardoise</b>			
<b>1010102</b>	L. 70 x l. 70 cm	x 1	<b>37,50 €</b>
<b>1010105</b>	L. 130 x l. 130 cm	x 1	<b>58,00 €</b>
<b>1010108</b>	L. 130 x l. 180 cm	x 1	<b>74,50 €</b>
<b>Tête à tête ardoise</b>			
<b>1010132</b>	L. 43 x l. 120 cm	x 3	<b>20,25 €</b>



<b>Nappe cacao</b>			
<b>1010103</b>	L. 70 x l. 70 cm	x 1	<b>37,50 €</b>
<b>1010106</b>	L. 130 x l. 130 cm	x 1	<b>58,00 €</b>
<b>1010109</b>	L. 130 x l. 180 cm	x 1	<b>74,50 €</b>
<b>Tête à tête cacao</b>			
<b>1010133</b>	L. 43 x l. 120 cm	x 3	<b>20,25 €</b>



<b>Nappe grège</b>			
<b>1010104</b>	L. 70 x l. 70 cm	x 1	<b>37,50 €</b>
<b>1010107</b>	L. 130 x l. 130 cm	x 1	<b>58,00 €</b>
<b>1010110</b>	L. 130 x l. 180 cm	x 1	<b>74,50 €</b>
<b>Tête à tête grège</b>			
<b>1010169</b>	L. 43 x l. 120 cm	x 3	<b>20,25 €</b>

## Nappage Western



<b>Nappe chocolat</b>			
<b>1010111</b>	L. 70 x l. 70 cm	x 1	<b>37,50 €</b>
<b>1010114</b>	L. 130 x l. 130 cm	x 1	<b>58,00 €</b>
<b>1010117</b>	L. 130 x l. 180 cm	x 1	<b>74,50 €</b>
<b>Tête à tête chocolat</b>			
<b>1010134</b>	L. 43 x l. 120 cm	x 3	<b>20,25 €</b>

ART DE LA TABLE

# OPTEZ POUR LE ROULEAU AU MÈTRE

## Rouleau Sonoclean

En PVC souple effet tissu. Epaisseur 300g/m<sup>2</sup>. Imperméable. Lavable à l'éponge. PVC souple effet tissu garanti. Antichoc et antibruit. Brulûre possible par effet loupe sur les verres avec les rayons directs du soleil.



Gris					P.U.HT
1007673	L. 10 x l. 1,40 m	x 1			266,00 €
1007675	L. 20 x l. 1,40 m	x 1			501,00 €



## Rouleau Magilys

Maille 100% polyester très résistante, lisse et satinée. Epaisseur 220g/m<sup>2</sup>. Sans repassage.



Gris					P.U.HT
1007666	L. 10 x l. 1,50 m	x 1			137,00 €
1007669	L. 20 x l. 1,50 m	x 1			259,00 €



## SETS

### Sonoclean

100 % polyester PVC. 300 g/m<sup>2</sup>. Facile d'entretien, imperméable, lavable à l'éponge.

#### Set Jean réversible

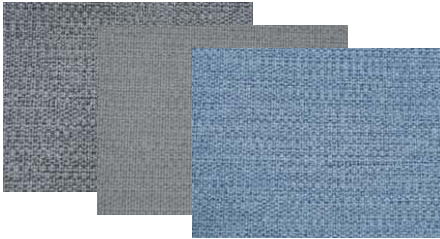

L. 50 x l. 33 cm					P.U.HT
1010170	Jean Gris / Ivoire	x 1			14,40 €
1010171	Jean Beige / Ardoise	x 1			14,40 €
1010173	Jean Bleu / Camel	x 1			14,40 €

#### Set Tiss



L. 43 x l. 33 cm					P.U.HT
1010179	Anis	x 3			10,30 €
1010176	Chocolat	x 3			10,30 €
1010177	Gris	x 3			10,30 €
1010178	Rouge	x 3			10,30 €
1010175	Taupe	x 3			10,30 €

#### Set Vintage



L. 43 x l. 33 cm					P.U.HT
1010191	Ardoise	x 3			10,30 €
1010190	Cacao	x 3			10,30 €
1010189	Grège	x 3			10,30 €
1010172	Cacao / Grège	x 1			14,40 €

#### Set Carreaux



L. 43 x l. 33 cm					P.U.HT
1010185	Rouge / Beige	x 3			10,30 €

#### Set Jean

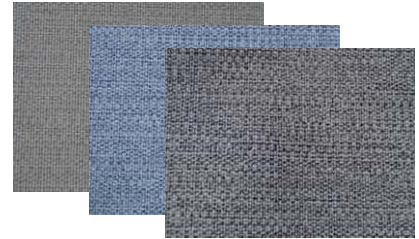

L. 43 x l. 33 cm					P.U.HT
1010187	Beige	x 3			10,30 €
1010186	Bleu	x 3			10,30 €
1010188	Gris	x 3			10,30 €

#### Set Vache

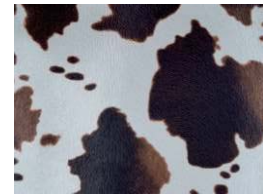

L. 43 x l. 33 cm					P.U.HT
1010180		x 3			10,30 €

#### Set Western



L. 43 x l. 33 cm					P.U.HT
1010183	Chocolat	x 3			10,30 €





## Panière ronde réversible

100% polyester.

### Panière Taupe/Beige

<b>1010156</b>	Ø 20 cm	x 6	<b>P.U.HT</b>
<b>1010153</b>	Ø 15 cm	x 6	<b>20,50 €</b>
<b>1010146</b>	Ø 10 cm	x 6	<b>16,50 €</b>
			<b>13,50 €</b>

### Panière Gris/Beige

<b>1010157</b>	Ø 20 cm	x 6	<b>P.U.HT</b>
<b>1010154</b>	Ø 15 cm	x 6	<b>20,50 €</b>
<b>1010147</b>	Ø 10 cm	x 6	<b>16,50 €</b>
			<b>13,50 €</b>

### Panière Rouge/Taupe

<b>1010158</b>	Ø 20 cm	x 6	<b>P.U.HT</b>
<b>1010155</b>	Ø 15 cm	x 6	<b>20,50 €</b>
<b>1010148</b>	Ø 10 cm	x 6	<b>16,50 €</b>
			<b>13,50 €</b>



## Panière oeil

100% polyester.

### Ronde Ø 15 cm

<b>1010149</b>	Jean Bleu / Vintage Camel	x 1	<b>P.U.HT</b>
<b>1010150</b>	Jean Gris / Vintage Ivoire	x 1	<b>16,50 €</b>
<b>1010151</b>	Jean Beige / Ardoise	x 1	<b>16,50 €</b>
<b>1010152</b>	Vintage Cacao / Grège	x 1	<b>16,50 €</b>

### Panière Tiss chocolat

<b>1010159</b>	17 x 14 x H. 14 cm	x 6	<b>P.U.HT</b>
<b>1002043</b>	14 x 10,5 x H. 12 cm	x 6	<b>20,50 €</b>
<b>1002023</b>	12,5 x 9 x H. 11 cm	x 6	<b>15,75 €</b>
			<b>13,00 €</b>

### Panière Tiss rouge

<b>1010160</b>	17 x 14 x H. 14 cm	x 6	<b>P.U.HT</b>
<b>1002045</b>	14 x 10,5 x H. 12 cm	x 6	<b>20,50 €</b>
<b>1002025</b>	12,5 x 9 x H. 11 cm	x 6	<b>15,75 €</b>
			<b>13,00 €</b>

### Panière Tiss beige

<b>1002021</b>	12,5 x 9 x H. 11 cm	x 6	<b>P.U.HT</b>
			<b>13,00 €</b>

### Panière Tiss taupe

<b>1002022</b>	12,5 x 9 x H. 11 cm	x 6	<b>P.U.HT</b>
			<b>13,00 €</b>



## Santorini

Collection en PVC, protection antibactérienne Microban®. Nettoyage facile avec de l'eau et du savon. Finition soignée grâce à une découpe « ultra son ». Ignifugée et écologique. Ne fronce pas, ne se décolore pas.

**Pio  
Tavola**

### Set rectangulaire



#### Ardoise

<b>1010643</b>	L. 40 x l. 30 cm	x 1	<b>P.U.HT</b>
<b>1010642</b>	L. 45 x l. 30 cm	x 1	<b>9,00 €</b>
			<b>9,90 €</b>



#### Rouge

<b>1010628</b>	L. 40 x l. 30 cm	x 1	<b>P.U.HT</b>
<b>1010629</b>	L. 45 x l. 30 cm	x 1	<b>9,00 €</b>
			<b>9,90 €</b>

### Set rond

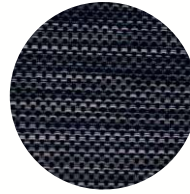

#### Ardoise

<b>1010638</b>	Ø 35 cm	x 1	<b>P.U.HT</b>
			<b>12,50 €</b>

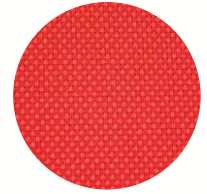

#### Rouge

<b>1010633</b>	Ø 35 cm	x 1	<b>P.U.HT</b>
<b>1010634</b>	Ø 40 cm	x 1	<b>12,90 €</b>
			<b>13,40 €</b>

### Set ovale



#### Ardoise

<b>1010625</b>	L. 40 x l. 30 cm	x 1	<b>P.U.HT</b>
<b>1010626</b>	L. 42 x l. 31 cm	x 1	<b>12,90 €</b>
<b>1010627</b>	L. 46 x l. 36 cm	x 1	<b>15,50 €</b>

#### Rouge

<b>1010635</b>	L. 40 x l. 30 cm	x 1	<b>P.U.HT</b>
<b>1010636</b>	L. 42 x l. 31 cm	x 1	<b>12,90 €</b>
<b>1010637</b>	L. 46 x l. 36 cm	x 1	<b>15,50 €</b>

### Tête à tête



#### Ardoise

<b>1010641</b>	L. 45 x l. 60 cm	x 1	<b>P.U.HT</b>
<b>1010640</b>	L. 45 x l. 70 cm	x 1	<b>14,90 €</b>
<b>1010639</b>	L. 45 x l. 80 cm	x 1	<b>16,75 €</b>
			<b>18,25 €</b>

#### Rouge

<b>1010630</b>	L. 45 x l. 60 cm	x 1	<b>P.U.HT</b>
<b>1010631</b>	L. 45 x l. 70 cm	x 1	<b>14,90 €</b>
<b>1010632</b>	L. 45 x l. 80 cm	x 1	<b>16,75 €</b>
			<b>18,25 €</b>



## Rouleau de protège table

En PVC.



Transparent

**1007682**

L. 20 x l. 1,40 m - Ep. 0,3 mm



x 1

**P.U.HT**

**189,00 €**

**1007681**

L. 20 x l. 1,40 m - Ep. 0,1 mm

x 1

**106,00 €**

## Juponnage Magilys

100 % polyester. Epaisseur 165 g/m<sup>2</sup>.  
Lavage à 40°. Juponnage incluant les clips.



Blanc

**1006430**

H. 73 cm x L. 4 m



x 1

**P.U.HT**

**241,00 €**

## Juponnage

En non tissé Dunicel, épaisseur 140g/m<sup>2</sup>.  
Bande auto-adhésive pour une grande fonctionnalité et une mise en place rapide. Tombé impeccable.  
Parfait complément d'une nappe tissée ou non tissée.  
Autres coloris, nous consulter.



Blanc

**51046P**

0,72 x 4 m



x 5

**P.U.HT**

**34,25 €**

## PROTÈGE TABLE

### Rouleau de protège table

En molleton. Epaisseur 650 g/m<sup>2</sup>. A relief, idéale pour protéger les tables pendant le service.



Blanc

**1007679**

L. 20 x l. 1,40 m



x 1

**P.U.HT**

**357,00 €**

### Rouleau de protège table

En molleton. Epaisseur 430g/m<sup>2</sup>. Envers PVC.



Blanc

**1007680**

L. 20 x l. 2 m



x 1

**P.U.HT**

**607,00 €**

### Protège-table imperméable

100 % coton. Epaisseur 420 g/m<sup>2</sup>. Enduction PVC. Résiste aux plats chauds jusqu'à 150 °C. Antidérapant.



Blanc

**41426**

Ø 130 cm



x 1

**P.U.HT**

**22,75 €**

### Protège-table imperméable

100 % coton. Enduction PVC. Résiste aux plats chauds jusqu'à 150 °C. Antidérapant.



Blanc

**42541**

L. 70 x l. 70 cm



x 1

**P.U.HT**

**7,60 €**

**42542**

L. 110 x l. 70 cm



x 1

**10,20 €**

## ACCESSOIRES

### Ciseau

Ciseau électrique pour découper les rouleaux de nappe. Permet un découpage net et soigné pour une mise en place qualitative. Maniable et facile d'utilisation. Fonctionne avec 2 piles LR6 (non fournies).



**69787**



x 1

**P.U.HT**

**20,25 €**

### Pince nappe

S'adapte facilement à votre table pour maintenir votre nappe. L'idéal pour les repas en extérieur afin que la nappe ne s'envole pas ou tout simplement lors de grandes tablées pour éviter les glissements.



Plastique blanc

**48515P**



x 30

**P.U.HT**

**1,20 €**

### Cale de table

Permet d'empêcher la table de bouger.



Plastique blanc

Sachet de 30

**56593P**



x 1

**P.U.HT**

**35,00 €**

Inox poli brillant

Boîte de 4

**1000556P**



x 1

**P.U.HT**

**3,40 €**





SUPPLIER OF GOODFOODMOOD®



## **CRÉEZ VOTRE PROPRE VISION DE L'ESPRIT GOODFOODMOOD®**

La collection Duni offre un nombre infini de solutions pour créer l'ambiance que vous recherchez... Elle offre un vaste choix de couleurs, décors, bougies et accessoires à coordonner, ainsi qu'un large éventail de matériaux écoresponsables de qualité supérieure.

Offrez une expérience singulière qui donnera à vos clients  
l'envie de prolonger ou de renouveler leur visite !





# USAGE UNIQUE

**NAPPAGE .....288**

**VAISSELLE.....306**

**VENTE À EMPORTER .....316**



nouveau !



**Maja**  
Opaque et résistant.



Set non tissé Dunicel  
Paquet de 100  **P.U.HT**  
**1013729** L. 30 x L. 40 cm x 5 **29,75 €**

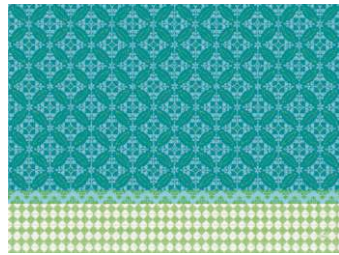

Set papier  
Paquet de 250  **P.U.HT**  
**1013746** L. 30 x L. 40 cm x 4 **20,50 €**



Serviette non tissé Dunilin  
Paquet de 50  **P.U.HT**  
**1013744** L. 40 x l. 40 cm x 5 **13,30 €**

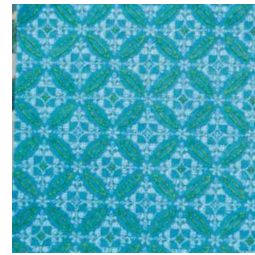

Serviette ouate 3 plis  
Paquet de 250  **P.U.HT**  
**1013750** L. 40 x l. 40 cm x 4 **26,75 €**



**Linén**  
Décor exclusif.

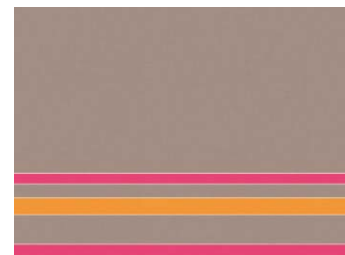

Set papier  
Paquet de 250  **P.U.HT**  
**A 1003658P** L. 30 x L. 40 cm x 4 **20,00 €**



Serviette pliée en 8 Dunicel  **P.U.HT**  
Format plié 20 x 10 cm  
Paquet de 300  
**1003660P** L. 40 x l. 40 cm x 4 **23,50 €**



Serviette non tissé Dunicel  **P.U.HT**  
Format plié 20 x 20 cm  
Paquet de 125  
**1003659P** L. 40 x l. 40 cm x 16 **9,30 €**



Pochette papier avec  
serviette Dunicel  **P.U.HT**  
Paquet de 500  
**1003661P** L. 23 x l. 11,5 cm x 1 **159,00 €**

nouveau !



# ALBERTO

## Alberto

Matière non-tissée. Opaque et résistante.

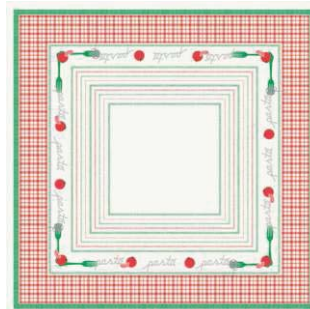

Nappe Dunicel  
Paquet de 100

**1013728** L. 84 x l. 84 cm



x 1

P.U.HT

**127,00 €**

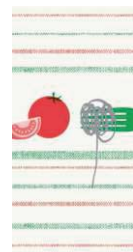

A

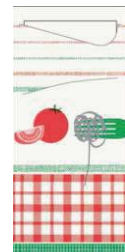

B

Serviette ouate pliée en 8  
Paquet de 300

**A 1013748** L. 33 x l. 33 cm



x 4

P.U.HT

**11,50 €**

Pochette papier avec  
serviette ouate  
Paquet de 100



x 5

P.U.HT

**B 1013725** L. 19 x l. 8,5 cm

x 5

**18,25 €**

Serviette ouate - 4 plis  
Paquet de 50

**1013751** L. 40 x l. 40 cm



x 6

P.U.HT

**7,40 €**

Serviette ouate - 3 plis  
Paquet de 50

**1013749** L. 33 x l. 33 cm



x 10

P.U.HT

**4,10 €**



# GIOVANNI

## Giovanni

Décor esprit brasserie. Aspect du Lin. Matière non-tissée haut de gamme, opaque et résistante.

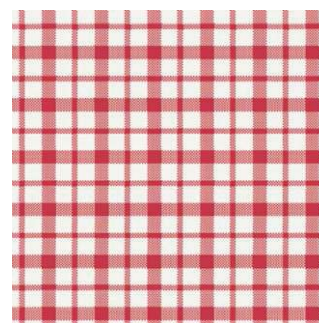

Nappe Dunicel  
Paquet de 100

**1003698** L. 84 x l. 84 cm



x 1

P.U.HT

**99,50 €**

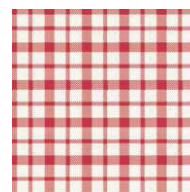
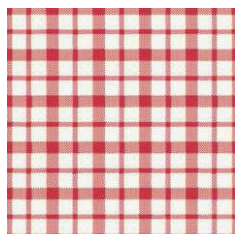
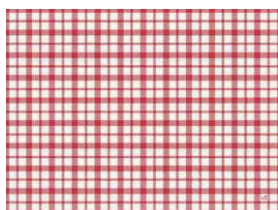

Set papier  
Paquet de 250

**1003695P** l. 30 x l. 40 cm



x 4

P.U.HT

**23,00 €**

Serviette ouate - 3 plis  
Paquet de 250

**1010669** L. 40 x l. 40 cm

x 4

**31,70 €**

Serviette ouate - 3 plis  
Paquet de 250

**1003697P** L. 33 x l. 33 cm

x 4

**22,00 €**





## Montagne

Matière opaque et résistante.



Set Dunicel - Paquet de 100  
**1010651** l. 30 x l. 40 cm

x 5

**P.U.HT**  
**28,25 €**



Serviette ouate 3 plis - Paquet de 250  
**1010652** L. 33 x l. 33 cm

x 4

**P.U.HT**  
**18,50 €**

Serviette Dunilin - Paquet de 50  
**1010649** L. 40 x l. 40 cm

x 12

**P.U.HT**  
**12,90 €**

Set papier - Paquet de 250  
**1010650** l. 30 x l. 40 cm

x 4

**P.U.HT**  
**19,00 €**



## Vintage Linus

Rouleau de 20 bandes de tête-à-tête de 1,20 m.



Rouleau de tête à tête Dunicel

**1010656** L. 24 x l. 0,40 m

x 4

**P.U.HT**  
**22,25 €**



Serviette Dunisoft pliée en 8 - Paquet de 120  
**1010658** L. 20 x l. 40 cm

x 12

**P.U.HT**  
**14,90 €**

Serviette Dunilin - Paquet de 50  
**1010662** L. 40 x l. 40 cm

x 12

**P.U.HT**  
**12,90 €**

Set papier - Paquet de 250  
**1010659** l. 30 x l. 40 cm

x 4

**P.U.HT**  
**33,50 €**



## Serviette torchon

Motif inspiré du torchon. En Airlaid 55 g/m<sup>2</sup>. Livré à plat.

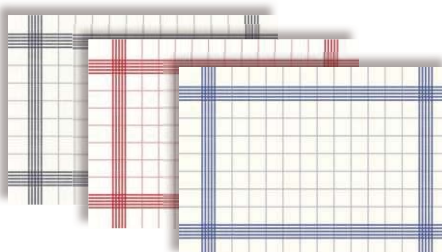

l. 38 x L. 54 cm - Paquet de 250

**1007584** blanc / bleu  
**1007585P** blanc / rouge  
**1007586P** blanc / gris

x 1  
x 1  
x 1

**P.U.HT**  
**68,50 €**  
**68,50 €**  
**68,50 €**



## LE BISTRO

### Set papier

Epaisseur 60 g/m<sup>2</sup>. 30 x 40 cm. Certifié FSC.



**Le bistro**  
 1007015P Paquet de 250 x 4 **P.U.HT 21,90 €**



## BY THE SEA

nouveau !

### Set papier

2 décors assortis dans le même paquet.  
 Epaisseur 60g/m<sup>2</sup>. 30 x 40 cm. Certifié FSC.



**By the sea**  
 1013745 Paquet de 250 x 4 **P.U.HT 18,90 €**

### Set papier

Gaufré 60 g/m<sup>2</sup>. 30 x 40 cm. Autres décors nous consulter.



**Cabanon**  
 1010579 Paquet de 500 x 4 **P.U.HT 36,00 €**



**Ardoise**  
 1010580 Paquet de 500 x 4 **P.U.HT 36,00 €**



**Edelweiss**  
 1010581 Paquet de 500 x 4 **P.U.HT 36,00 €**

nouveau !

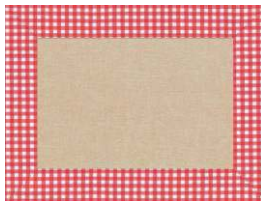

**Vichy rouge**  
 1000525 Paquet de 500 x 4 **P.U.HT 36,00 €**



**Acidulé**  
 69103P Paquet de 500 x 4 **P.U.HT 36,00 €**



**Smoking**  
 64425P Paquet de 500 x 1 **P.U.HT 36,00 €**



**Feuille d'Or**  
 58371P Paquet de 500 x 1 **P.U.HT 36,00 €**



## CÉLINE

### Set papier

Epaisseur 45 g/m<sup>2</sup>. 30 x 40 cm.



**Céline - Ep. 50 g/m<sup>2</sup>**  
 65108P Paquet de 500 x 4 **P.U.HT 36,00 €**

nouveau !



**Pépité - Epaisseur 80g/m<sup>2</sup>**  
 1013397 Carton de 500 x 1 **P.U.HT 16,25 €**

## ENFANTS

### Kit enfant à colorier

Epaisseur 120 g/m<sup>2</sup>. 30 x 40 cm.



Composé d'un set et d'une pochette contenant une serviette (4 coloris assortis) et 6 crayons de couleurs.

**Le kit**  
 1003411P Paquet de 100 x 1 **P.U.HT 68,50 €**

nouveau !

### Mandala kids

Pratique, hygiénique et ludique. 30 x 40 cm. Certifié FSC. Epaisseur 60 g/m<sup>2</sup>.



**Pépité**  
 1013747 Carton de 250 x 4 **P.U.HT 18,25 €**





# EVOLIN



## Evolin

En non tissé. Une matière exclusive et révolutionnaire. Fibres certifiées FSC, unités de production certifiées ISO14001. Compostable conformément à la norme européenne EN 13432.



Couleur	Nappe au format					Tête à tête	Set
Dim.	Ø 240 cm	l. 127 x L. 220 cm	l. 127 x L. 180 cm	l. 127 x L. 127 cm	l. 110 x L. 110 cm	l. 0,41 x L. 24 m	l. 30 x L. 43 cm
Cond.	Paquet de 10	Paquet de 25	Paquet de 25	Paquet de 50	Paquet de 50	Rouleau	Paquet de 70
	x 1	x 1	x 1	x 1	x 1	x 4	x 5
Blanc	<b>1007646</b>	<b>1001734</b>	<b>1001732</b>	-	<b>1001728P</b>	<b>1001673</b>	<b>1013719</b>
<b>Prix HT</b>	<b>118,00 €</b>	<b>63,00 €</b>	<b>50,50 €</b>		<b>54,50 €</b>	<b>17,25 €</b>	<b>21,00 €</b>
Noir	<b>1007648</b>	-	<b>1002108</b>	-	<b>1002106</b>	<b>1001672P</b>	<b>1013724</b>
Bordeaux	-	<b>1007554</b>	<b>1007560</b>	<b>1007558</b>	<b>1007557</b>	<b>1007552</b>	<b>1013720</b>
Crème	<b>1007647</b>	<b>1001735</b>	<b>1001733</b>	<b>1001731</b>	<b>1001729P</b>	<b>1001674</b>	<b>1013721</b>
Granite	-	<b>1003684</b>	<b>1003681</b>	-	<b>1003683</b>	<b>1003685</b>	<b>1013722</b>
Grège	-	<b>1007556</b>	<b>1007561</b>	<b>1007555</b>	<b>1007559</b>	<b>1007553</b>	<b>1013723</b>
<b>Prix HT</b>	<b>118,00 €</b>	<b>74,00 €</b>	<b>60,00 €</b>	<b>80,00 €</b>	<b>69,00 €</b>	<b>19,00 €</b>	<b>24,00 €</b>



NAPPE AU FORMAT



ROULEAU TÊTE À TÊTE



SET BLANC



# DUNICEL

## Dunicel

En non tissé. Epaisseur 140 g/m<sup>2</sup>. Un matériau lourd et opaque pour draper impeccablement vos tables. Avec un tombé textile, il est également très résistant. Autres coloris nous consulter



Couleur	Nappe au format		Nappe en rouleau		Tête à tête	Set Linnéa
	Ø 240 cm	l. 125 x L. 125 cm	l. 1,25 x L. 25 m	l. 1,25 x L. 10 m	l. 0,40 x L. 24 m	l. 30 x L. 40 cm
Cond.	Paquet de 5	Paquet de 50	Lot de 2 rouleaux	Rouleau	Rouleau	Paquet de 100
	x 2	x 1	x 1	x 6	x 4	x 5
Blanc	<b>59319P</b>	<b>67703P</b>	<b>57101P</b>	-	-	<b>1010666P</b>
<b>Prix HT</b>	<b>53,00 €</b>	<b>93,50 €</b>	<b>91,50 €</b>			<b>14,90 €</b>
Noir	-	-	-	<b>1013716P</b>	<b>1013739P</b>	<b>1010607P</b>
Bordeaux	-	-	<b>57104P</b>	-	<b>1013731P</b>	<b>1010608P</b>
Crème	<b>1010670</b>	<b>1000707</b>	<b>57106P</b>	-	<b>1013732P</b>	<b>1010610P</b>
Granite	-	-	-	-	<b>1013734P</b>	<b>1010613P</b>
Grège	-	-	-	<b>1013715P</b>	<b>1013742P</b>	<b>1010614P</b>
Noisette	-	-	-	<b>1013717P</b>	<b>1013740P</b>	-
Rouge	-	-	-	-	<b>1013737P</b>	<b>1010618P</b>
Mandarine	-	-	-	-	<b>1013736P</b>	<b>1010616P</b>
Fuchsia	-	-	-	-	<b>1013733P</b>	<b>1010612P</b>
Prune	-	-	-	<b>1013718</b>	<b>1013741P</b>	-
Menthe bleue	-	-	-	-	<b>1013738P</b>	-
Bleu foncé	-	-	<b>57103P</b>	-	-	-
Kiwi	-	-	-	-	<b>1013735P</b>	<b>1010615P</b>
<b>Prix HT</b>	<b>52,50 €</b>	<b>107,00 €</b>	<b>97,50 €</b>	<b>22,75 €</b>	<b>16,00 €</b>	<b>19,00 €</b>



NON TISSÉ



USAGE UNIQUE

# LISAH



pro.mundi

## Lisah

En non-tissé 60 g/m<sup>2</sup>. Grande douceur au toucher et excellente tenue.

Couleur	Nappe en rouleau	Tête à tête
Dim.	I. 1,20 x L. 25 m	I. 0,40 x L. 24 m
	x 2	x 4
Blanc	✓ 66338P	66316P
<b>Prix HT</b>	<b>20,50 €</b>	<b>9,10 €</b>
Noir ébène	66343P	66313P
Bordeaux	66339P E	66317P
Ivoire	✓ 66342P	66311P
Gris béton	-	66315P
Gris titane	1001719P E	-
Chocolat	-	66312P
Terracotta	-	66314P
Rouge	-	69331P
Mandarine	-	1003261P
Framboise	-	68099P
Aubergine	-	1003259P
Bleu lagon	-	1003260P
Vert granny	66350P E	✓ 66318P
<b>Prix HT</b>	<b>30,50 €</b>	<b>10,80 €</b>

Tête à tête pré-découpé tous les 30 cm :

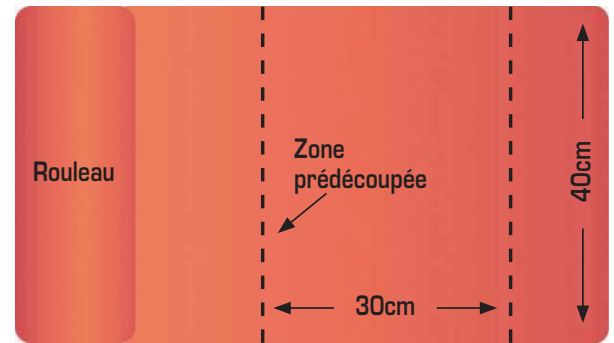





# SPUNBOND



## Spunbond

En non tissé spunbond. Epaisseur 60 g/m<sup>2</sup>. Chic, résistant, déperlant et épongeable. Tête à tête pré-découpé tous les 1,20 m.

Couleur	Nappe en rouleau	Tête à tête	Set
Dim.	I. 1,20 x L. 25 m	I. 0,40 x L. 24 m	I. 30 x L. 40 cm
Cond	Rouleau	Rouleau	Paquet de 100
	x 4	x 4	x 5
	Blanc	<b>1006576 E</b>	<b>1010586</b>
	<b>Prix HT</b>	<b>20,50 €</b>	<b>8,00 €</b>
	Noir	<b>1006579 E</b>	<b>1010583P</b>
	Bordeaux	<b>1010554</b>	<b>1010589</b>
	Ivoire	<b>1006578 E</b>	<b>1010585</b>
	Gris	<b>1010557</b>	<b>1010592</b>
	Anthracite	<b>1010556</b>	<b>1010591</b>
	Chocolat	<b>1006577 E</b>	<b>1010584</b>
	Rouge	<b>1006580P E</b>	<b>1010582</b>
	Fuchsia	<b>1010553 E</b>	<b>1010588</b>
	Violet	<b>1010558</b>	<b>1010593</b>
	Turquoise	<b>1006581 E</b>	<b>1010587</b>
	Kiwi	<b>1010555</b>	<b>1010590</b>
	<b>Prix HT</b>	<b>20,50 €</b>	<b>8,00 €</b>

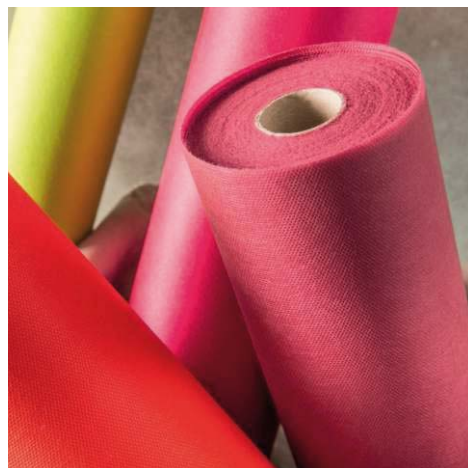



## Papier gaufré



En papier gaufré nid d'abeille. Epaisseur 45 g/m<sup>2</sup>. Rendu satiné pour les sets et nappes de couleur (encre alimentaire aqueuse sans solvants, sans métaux lourds, traitée haute tenue à la lumière). Autres coloris nous consulter.

Couleur	Nappe au format							Set Tisslack
	Dim. Ø 120 cm	l. 80 x L. 120 cm	70 x 120 cm	70 x 110 cm	80 x 80 cm	l. 70 x 70 cm	l. 60 x 60 cm	
Cond	Paquet de 250	Paquet de 250	Paquet de 250	Paquet de 250	Paquet de 250	Paquet de 500	Paquet de 500	Paquet de 500
Cond	x 1	x 1	x 1	x 1	x 1	x 1	x 1	x 4
Blanc	<b>1003363P</b>	<b>1003358P</b>	<b>1003357P</b>	<b>1010571P</b>	<b>1003359P</b>	<b>1003360P</b>	<b>1003361P</b>	✓ <b>1003356P</b> (Paquet de 1000) x 1
<b>Prix HT</b>	<b>91,50 €</b>	<b>34,75 €</b>	<b>27,25 €</b>	<b>22,25 €</b>	<b>20,75 €</b>	<b>26,75 €</b>	<b>23,25 €</b>	<b>19,25 €</b>
Noir	-	-	-	-	-	-	-	<b>1010578P</b>
Bordeaux	-	-	-	-	-	<b>57186P</b>	<b>57183P</b>	<b>57180P</b>
Ivoire	-	-	-	-	-	-	<b>63055</b>	<b>1005307P</b>
Gris	-	-	-	-	-	<b>1003364P</b>	-	✓ <b>1003353P</b>
Taupe	-	-	-	-	-	-	-	<b>1010577</b>
Chocolat	-	-	-	-	-	<b>59485P</b>	<b>59474</b>	✓ <b>59469P</b>
Terracotta	-	-	-	-	-	-	-	<b>59465P</b>
Rouge	-	-	-	-	-	<b>59481</b>	<b>59471</b>	✓ <b>59464P</b>
Cognac	-	-	-	-	-	-	-	<b>57181P</b>
Aubergine	-	-	-	-	-	-	-	✓ <b>1003354P</b>
Turquoise	-	-	-	-	-	-	-	<b>1003352P</b>
Vert kiwi	-	-	-	-	-	-	-	✓ <b>1003355P</b>
<b>Prix HT</b>						<b>50,50 €</b>	<b>41,00 €</b>	<b>15,25 €</b>



# DAMASSÉE

## Damassée

En papier. Épaisseur 45 g/m<sup>2</sup>.



Couleur	Nappe en rouleau			
	I. 1,20 x L. 100 m x 1	I. 1,00 x L. 100 m x 4	I. 1,18 x 25 m x 6	I. 1,20 x 10 m x 30
Blanc	69400P E	69402	-	69401P
<b>Prix HT</b>	<b>22,25 €</b>	<b>20,50 €</b>		<b>3,40 €</b>
Bordeaux	-	-	67606 E	-
Béton	-	-	1003648	-
Framboise	-	-	1003649	-
Pistache	-	-	67608 E	-
<b>Prix HT</b>			<b>12,40 €</b>	

## Set Kraft

En papier. Épaisseur 60 g/m<sup>2</sup>.



### KRAFT

nouveau !

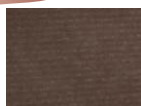

Chocolat

Paquet de 500

**70238P**

I. 30 x L. 40 cm



x 1

**P.U. HT**

**27,00 €**



Brun

Paquet de 500

**69398P**

I. 30 x L. 40 cm



x 1

**P.U. HT**

**16,50 €**

## Set antidérapant

En papier de qualité supérieure. Épaisseur 90 g/m<sup>2</sup>. Nouveau matériau antidérapant à l'aspect de velours.



### ANTIDÉRAPANT



Ardoise

Paquet de 500

**71155P**

I. 30 x L. 40 cm



x 1

**P.U. HT**

**75,00 €**



Chocolat

Paquet de 500

**71156P**

I. 30 x L. 40 cm



x 1

**P.U. HT**

**75,00 €**

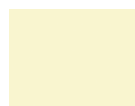

Champagne

Paquet de 500

**71157P**

I. 30 x L. 40 cm



x 1

**P.U. HT**

**75,00 €**



## **Cgmp leader français de la table éphémère.**

Une large gamme de couleurs vives ou pastel, made in France.

Cgmp vous assure une réactivité et une prise en charge de vos besoins pour répondre à l'ensemble de vos attentes.

Personnalisations, tendances, matières, un large choix de possibilité pour votre table !



AIRLAID



AIRLAID PLIÉE

## Serviette Airlaid

En non tissé. Epaisseur 55 g/m<sup>2</sup>. Matière résistante et très absorbante, à l'aspect et au toucher proche de celui du tissu. Une face gaufrée et une face lisse pour l'essuyage. Certifié FSC.



	<b>Blanc</b> Paquet de 60 48 x 48 cm x 6 <b>61519P</b> 40 x 40 cm x 12 <b>55346P</b>	<b>P.U.HT</b> <b>10,60 €</b>		<b>Rouge</b> 40 x 40 cm Paquet de 60 <b>57095P</b>	<b>P.U.HT</b> <b>6,80 €</b>
	<b>Noir</b> 40 x 40 cm Paquet de 60 <b>64622P</b>	<b>P.U.HT</b> <b>6,80 €</b>		<b>Jaune</b> 40 x 40 cm Paquet de 60 <b>57093P</b>	<b>P.U.HT</b> <b>6,80 €</b>
	<b>Bordeaux</b> 40 x 40 cm Paquet de 60 <b>55345P</b>	<b>P.U.HT</b> <b>6,80 €</b>		<b>Mandarine</b> 40 x 40 cm Paquet de 60 <b>1000593P</b>	<b>P.U.HT</b> <b>6,80 €</b>
	<b>Crème</b> Paquet de 60 48 x 48 cm x 6 <b>61520</b> 40 x 40 cm x 12 <b>55348P</b>	<b>P.U.HT</b> <b>14,20 €</b>		<b>Fuchsia</b> 40 x 40 cm Paquet de 60 <b>1000592P</b>	<b>P.U.HT</b> <b>6,80 €</b>
	<b>Granite</b> 40 x 40 cm Paquet de 60 <b>64502P</b>	<b>P.U.HT</b> <b>6,80 €</b>		<b>Prune</b> 40 x 40 cm Paquet de 60 <b>1000594P</b>	<b>P.U.HT</b> <b>6,80 €</b>
	<b>Grège</b> 40 x 40 cm Paquet de 60 <b>1003653P</b>	<b>P.U.HT</b> <b>6,80 €</b>		<b>Menthe bleu</b> 40 x 40 cm Paquet de 60 <b>1006404P</b>	<b>P.U.HT</b> <b>6,80 €</b>
	<b>Noisette</b> 40 x 40 cm Paquet de 60 <b>1007533P</b>	<b>P.U.HT</b> <b>6,80 €</b>		<b>Bleu foncé</b> 40 x 40 cm Paquet de 60 <b>55344P</b>	<b>P.U.HT</b> <b>6,80 €</b>
	<b>Eco Echo</b> 40 x 40 cm Paquet de 60 <b>1010686P</b>	<b>P.U.HT</b> <b>6,80 €</b>		<b>Kiwi</b> 40 x 40 cm Paquet de 60 <b>1000298P</b>	<b>P.U.HT</b> <b>6,80 €</b>
	<b>Miel</b> 40 x 40 cm Paquet de 60 <b>1007534P</b>	<b>P.U.HT</b> <b>6,80 €</b>		<b>Vert foncé</b> 40 x 40 cm Paquet de 60 <b>55347P</b>	<b>P.U.HT</b> <b>6,80 €</b>

## Serviette Airlaid pliée en 8

En non tissé. 55 g/m<sup>2</sup>. Pliée en 8 pour un gain de temps lors du dressage. Certifié FSC.



	<b>Blanc</b> 40 x 40 cm Paquet de 60 <b>1010314P</b>	<b>P.U.HT</b> <b>5,70 €</b>
	<b>Noir</b> 40 x 40 cm Paquet de 60 <b>1010619P</b>	<b>P.U.HT</b> <b>7,70 €</b>
	<b>Bordeaux</b> 40 x 40 cm Paquet de 60 <b>1010683P</b>	<b>P.U.HT</b> <b>7,70 €</b>
	<b>Crème</b> 40 x 40 cm Paquet de 60 <b>1010682P</b>	<b>P.U.HT</b> <b>7,70 €</b>
	<b>Granite</b> 40 x 40 cm Paquet de 60 <b>1010687</b>	<b>P.U.HT</b> <b>7,70 €</b>

Serviette pliée pour un gain de temps lors du dressage.



SERVIETTES NON TISSÉ



USAGE UNIQUE



# SPUNLACE



# BASIK SOFT

nouveau !

## Spunlace

En Spunlaid. Épaisseur 70 g/m<sup>2</sup>. Serviette douce et résistante sans colle et sans latex. Imitation tissu.



**Blanc**

40 x 40 cm

Paquet de 50

**1013460**



x 12

**P.U.HT**

**9,60 €**



**Gris**

40 x 40 cm

Paquet de 50

**1013461**



x 12

**P.U.HT**

**9,30 €**



**Chataigne**

40 x 40 cm

Paquet de 50

**1013464**



x 12

**P.U.HT**

**9,60 €**

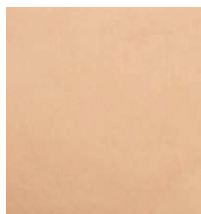

**Pêche**

40 x 40 cm

Paquet de 50

**1013463**



x 12

**P.U.HT**

**9,60 €**



**Anis**

40 x 40 cm

Paquet de 50

**1013462**



x 12

**P.U.HT**

**9,60 €**

nouveau !

## Basik Soft

Airlaid. Serviette non tissée douce et résistante.



**Blanc**

39 x 40 cm

Paquet de 50

**1013673P**



x 20

**P.U.HT**

**3,60 €**

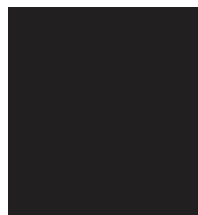

**Noir**

39 x 40 cm

Paquet de 50

**1013678P**



x 20

**P.U.HT**

**3,80 €**

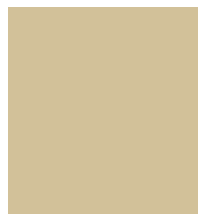

**Ivoire**

39 x 40 cm

Paquet de 50

**1013674P**



x 20

**P.U.HT**

**3,80 €**



**Gris**

39 x 40 cm

Paquet de 50

**1013676P**



x 20

**P.U.HT**

**3,80 €**



**Chocolat**

39 x 40 cm

Paquet de 50

**1013677P**



x 20

**P.U.HT**

**3,80 €**



**Rouge**

39 x 40 cm

Paquet de 50

**1013675P**



x 20

**P.U.HT**

**3,80 €**

Serviette pliée pour un gain de temps lors du dressage.



LISAH PLIÉE



## Serviette Lisah

Double point, 2 plis. Epaisseur 34 g/m<sup>2</sup>.  
Format plié 19 x 19 cm.



	<b>Jaune soleil</b> 38 x 38 cm Paquet de 50 ✔ <b>1003266P</b> x 18	<b>P.U.HT</b> <b>1,90 €</b>
	<b>Vert Granny</b> 38 x 38 cm Paquet de 50 ✔ <b>1003269P</b> x 18	<b>P.U.HT</b> <b>1,90 €</b>
	<b>Bleu azur</b> 38 x 38 cm Paquet de 50 ✔ <b>1010737P</b> x 18	<b>P.U.HT</b> <b>1,90 €</b>
	<b>Bordeaux</b> 38 x 38 cm Paquet de 50 ✔ <b>1006469P</b> x 18	<b>P.U.HT</b> <b>1,90 €</b>
	<b>Bleu Lagon</b> 38 x 38 cm Paquet de 50 ✔ <b>1003275P</b> x 18	<b>P.U.HT</b> <b>1,90 €</b>
	<b>Rouge</b> 38 x 38 cm Paquet de 50 ✔ <b>1003272P</b> x 18	<b>P.U.HT</b> <b>1,90 €</b>
	<b>Kraft</b> 38 x 38 cm Paquet de 50 ✔ <b>1003267P</b> x 18	<b>P.U.HT</b> <b>1,60 €</b>
	<b>Noir Ebène</b> 38 x 38 cm Paquet de 50 ✔ <b>1003262P</b> x 18	<b>P.U.HT</b> <b>1,90 €</b>
	<b>Taupe</b> 38 x 38 cm Paquet de 50 ✔ <b>1003273P</b> x 18	<b>P.U.HT</b> <b>1,90 €</b>
	<b>Terracotta</b> 38 x 38 cm Paquet de 50 ✔ <b>1003274P</b> x 18	<b>P.U.HT</b> <b>1,90 €</b>
	<b>Ivoire</b> 38 x 38 cm Carton de 50 ✔ <b>1005101P</b> x 18	<b>P.U.HT</b> <b>1,70 €</b>
	<b>Aubergine</b> 38 x 38 cm Paquet de 50 ✔ <b>1003263P</b> x 18	<b>P.U.HT</b> <b>1,90 €</b>
	<b>Chocolat</b> 38 x 38 cm Carton de 50 ✔ <b>1005102P</b> x 18	<b>P.U.HT</b> <b>1,90 €</b>
	<b>Framboise</b> 38 x 38 cm Paquet de 50 ✔ <b>1003270P</b> x 18	<b>P.U.HT</b> <b>1,90 €</b>
	<b>Béton</b> 38 x 38 cm Paquet de 50 ✔ <b>1003264P</b> x 18	<b>P.U.HT</b> <b>1,90 €</b>
	<b>Mandarine</b> 38 x 38 cm Paquet de 50 ✔ <b>1003268P</b> x 18	<b>P.U.HT</b> <b>1,90 €</b>
	<b>Blanc</b> 38 x 38 cm Paquet de 50 ✔ <b>1003265P</b> x 18	<b>P.U.HT</b> <b>1,60 €</b>

nouveau !

	<b>Blanc - Liseret bordeaux</b> 38 x 38 cm Paquet de 50 ✔ <b>1013754P</b> x 18	<b>P.U.HT</b> <b>1,60 €</b>
	<b>Chocolat - Liseret brun</b> 38 x 38 cm Paquet de 50 ✔ <b>1013755P</b> x 18	<b>P.U.HT</b> <b>1,90 €</b>

## Serviette Lisah pliée en 8

En celi-ouate. Epaisseur 16 g/m<sup>2</sup>.  
Format plié 19,5 x 10 cm.



Nappes Lisah  
page 294



**Blanc**  
38 x 38 cm  
Paquet de 50  
✔ **1007603** x 18
 **P.U.HT** **1,80 €** |

**Noir**  
38 x 38 cm  
Paquet de 50  
✔ **1007605P** x 18
 **P.U.HT** **2,20 €** |

**Ivoire**  
38 x 38 cm  
Paquet de 50  
✔ **1007606** x 18
 **P.U.HT** **2,20 €** |

**Béton**  
38 x 38 cm  
Paquet de 50  
✔ **1007609P** x 18
 **P.U.HT** **2,20 €** |

**Chocolat**  
38 x 38 cm  
Paquet de 50  
✔ **1007604P** x 18
 **P.U.HT** **2,20 €** |

**Rouge**  
38 x 38 cm  
Paquet de 50  
✔ **1007608P** x 18
 **P.U.HT** **2,20 €** |

SERVIETTES DOUBLE POINT



USAGE UNIQUE

## OUATE COULEUR

## Serviette ouate couleur

17 g/m<sup>2</sup>. Épaisseur 2 plis.

	<b>Noir</b> 39 x 39 cm Paquet de 150 <b>1008490P</b>		x 12	<b>P.U.HT</b> <b>5,00 €</b>
	<b>Bordeaux</b> 39 x 39 cm Paquet de 150 <b>1008489P</b>		x 12	<b>P.U.HT</b> <b>5,00 €</b>
	<b>Ivoire</b> 39 x 39 cm Paquet de 150 <b>1008491P</b>		x 12	<b>P.U.HT</b> <b>5,00 €</b>
	<b>Gris</b> 39 x 39 cm Paquet de 150 <b>1003341P</b>		x 12	<b>P.U.HT</b> <b>5,00 €</b>
	<b>Bistre</b> 39 x 39 cm Paquet de 150 <b>1003338P</b>		x 12	<b>P.U.HT</b> <b>5,00 €</b>
	<b>Terracotta</b> 39 x 39 cm Paquet de 150 <b>1008494P</b>		x 12	<b>P.U.HT</b> <b>5,00 €</b>
	<b>Rouge cerise</b> 39 x 39 cm Paquet de 150 <b>1008493P</b>		x 12	<b>P.U.HT</b> <b>5,00 €</b>
	<b>Aubergine</b> 39 x 39 cm Paquet de 150 <b>1008488P</b>		x 12	<b>P.U.HT</b> <b>5,00 €</b>
	<b>Bleu marine</b> 39 x 39 cm Paquet de 150 <b>1008496P</b>		x 12	<b>P.U.HT</b> <b>5,00 €</b>
	<b>Marron</b> 39 x 39 cm Paquet de 150 <b>1007686P</b>		x 12	<b>P.U.HT</b> <b>5,00 €</b>
	<b>Orange</b> 39 x 39 cm Paquet de 150 <b>1007687P</b>		x 12	<b>P.U.HT</b> <b>5,00 €</b>
	<b>Jaune</b> 39 x 39 cm Paquet de 150 <b>1007689P</b>		x 12	<b>P.U.HT</b> <b>5,00 €</b>
	<b>Rose fuchsia</b> 39 x 39 cm Paquet de 150 <b>1007688P</b>		x 12	<b>P.U.HT</b> <b>5,00 €</b>
	<b>Bleu clair</b> 39 x 39 cm Paquet de 150 <b>1007683</b>		x 12	<b>P.U.HT</b> <b>5,00 €</b>
	<b>Bleu pétrole</b> 39 x 39 cm Paquet de 150 <b>1007684P</b>		x 12	<b>P.U.HT</b> <b>5,00 €</b>
	<b>Citron vert</b> 39 x 39 cm Paquet de 150 <b>1007685P</b>		x 12	<b>P.U.HT</b> <b>5,00 €</b>
	<b>Champagne</b> 29 x 39 cm Paquet de 300 <b>1003347</b>		x 8	<b>P.U.HT</b> <b>8,50 €</b>
	<b>Marron</b> 29 x 39 cm Paquet de 300 <b>1007690</b>		x 8	<b>P.U.HT</b> <b>11,30 €</b>
	<b>Bordeaux</b> 33 x 33 cm Paquet de 200 <b>1008492P</b>		x 10	<b>P.U.HT</b> <b>5,00 €</b>
	<b>Rouge cerise</b> 33 x 33 cm Paquet de 200 <b>1008495P</b>		x 10	<b>P.U.HT</b> <b>5,00 €</b>

Serviette  
ouate blanche

2 plis - Paquet de 100  
**1013394P** L. 24 x l. 24 cm x 30 **P.U.HT**  
**1,40 €**



1 pli - Paquet de 400  
**1013393P** E L. 30 x l. 30 cm x 8 **P.U.HT**  
**3,00 €**



2 plis - Paquet de 100  
**64381P** E L. 30 x l. 30 cm x 48 **P.U.HT**  
**1,10 €**



2 plis - Paquet de 100  
**1013398P** L. 30 x l. 39 cm x 24 **P.U.HT**  
**1,80 €**



3 plis - Paquet de 100  
**1013379P** L. 39 x l. 39 cm x 18 **P.U.HT**  
**2,50 €**

## Serviette ouate blanche enchevêtrée



1 pli - Paquet de 250  
**60683P** L. 25 x l. 30 cm x 1 **P.U.HT**  
**2,20 €**

1 pli - Paquet de 1125  
**100003P** L. 21,6 x l. 33 cm x 8 **P.U.HT**  
**17,00 €**

2 plis - Paquet de 500  
**71189P** L. 21,6 x l. 33 cm x 8 **P.U.HT**  
**13,70 €**



1 pli décalé - Paquet de 250  
**1013396P** L. 29 x l. 29 cm x 12 **P.U.HT**  
**2,00 €**



2 plis - Paquet de 50  
**1010500P** E L. 48 x l. 48 cm x 12 **P.U.HT**  
**3,10 €**





COCKTAIL

### Serviette cocktail Airlaid

En non tissé. 55 g/m<sup>2</sup>. Pliée en 10 x 10 cm. Douce et souple. 20 x 20 cm. Certifié FSC.



L. 20 x l. 20 cm



Noir

Paquet de 180  
**1003652P**



x 16

**P.U.HT**  
**10,50 €**



Bordeaux

Paquet de 180  
**1003650**



x 16

**P.U.HT**  
**10,50 €**



Blanc

Paquet de 180  
**1006405P**



x 16

**P.U.HT**  
**9,10 €**

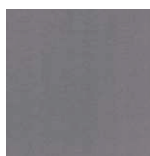

Granite

Paquet de 180  
**1010680**



x 16

**P.U.HT**  
**10,50 €**

### Serviette cocktail Céli-ouate

En Céli-ouate. 2 plis. 17 g/m<sup>2</sup>. Pliée 10 x 10 cm. Autres coloris, nous consulter. Personnalisable. 20 x 20 cm.



L. 20 x l. 20 cm



Merci

Paquet de 50  
**68084P**



x 18

**P.U.HT**  
**2,40 €**

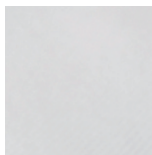

Blanc

Paquet de 50  
**65155P**



x 40

**P.U.HT**  
**0,97 €**



Ebène uni

Paquet de 50  
**1012599P**



x 18

**P.U.HT**  
**1,10 €**



Rouge

Paquet de 50  
**1003646P**



x 18

**P.U.HT**  
**1,10 €**

### 1<sup>er</sup> PRIX

### Serviette cocktail ouate

En ouate. 2 plis. 16 g/m<sup>2</sup>. Pliée 10 x 10 cm. Autres coloris et formats, nous consulter. Personnalisable. 20 x 20 cm.



L. 20 x l. 20 cm

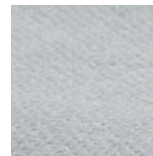

Béton

Paquet de 100  
**1006461P**



x 18

**P.U.HT**  
**1,90 €**

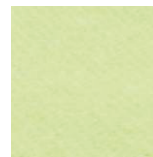

Pistache

Paquet de 100  
**1006465P**



x 18

**P.U.HT**  
**1,90 €**

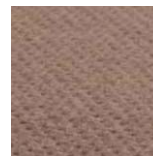

Chocolat

Paquet de 100  
**1006462P**



x 18

**P.U.HT**  
**1,90 €**

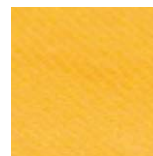

Mandarine

Paquet de 100  
**1006463P**



x 18

**P.U.HT**  
**1,90 €**



Framboise

Paquet de 100  
**1006464P**



x 18

**P.U.HT**  
**1,90 €**

### Distributeur de serviettes cocktail

En PVC transparent.



L. 11 x l. 11 cm

**1000591P**



x 12

**P.U.HT**  
**6,70 €**





## Duniletto

Serviette non tissée Dunilin, 70g/m<sup>2</sup>, 40 x 48 cm, prépliée pour former une pochette à couverts, 24 x 10 cm. Certifié FSC.



Noir

Paquet de 50

**69139P**



x 4

**P.U.HT**

**15,25 €**



Crème

Paquet de 50

**69140P**



x 4

**P.U.HT**

**15,25 €**



Granit

Paquet de 50

**64623P**



x 4

**P.U.HT**

**15,25 €**



Café

Paquet de 50

**64357P**



x 4

**P.U.HT**

**15,25 €**

## Duniletto Slim

Serviette non tissée, 55 g/m<sup>2</sup>, 40 x 33 cm, prépliée pour former une pochette à couverts, 24 x 10 cm. Certifié FSC.



Blanc

Paquet de 65

**1010690P**



x 4

**P.U.HT**

**12,70 €**

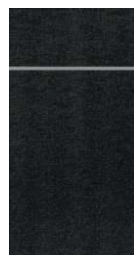

Noir

Paquet de 65

**1010692P**



x 4

**P.U.HT**

**12,70 €**



Granit

Paquet de 65

**1010691P**



x 4

**P.U.HT**

**12,70 €**

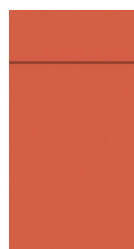

Mandarine

Paquet de 65

**1003679P**



x 4

**P.U.HT**

**12,70 €**



# SWITTY

## Switty

Serviette non tissée, 60g/m<sup>2</sup>, 40 x 40 cm, prépliée pour former un pochette à couverts, 20 x 10 cm.



Ebène

Paquet de 50

**1000161P**



x 10

**P.U.HT**

**12,00 €**



Bordeaux

Paquet de 50

**1003644P**



x 10

**P.U.HT**

**12,00 €**



Ivoire

Paquet de 50

**1000160P**



x 10

**P.U.HT**

**12,00 €**



Framboise

Paquet de 50

**1006472**



x 10

**P.U.HT**

**12,00 €**



# SACCHETO AIRLAID

# ISI

# ECOLINE

## Sachetto / serviette AirLaid



Pochette en papier 23 x 11,5 cm avec 2 ouvertures : l'une contenant une serviette AirLaid 32 x 40 cm en non tissé 55 g/m<sup>2</sup>, l'autre pour y glisser des couverts. Certifié FSC.



Noir

Paquet de 60  
**1005762P**



x 4

**P.U.HT**  
**14,60 €**



Crème

Paquet de 60  
**1005761P**



x 4

**P.U.HT**  
**14,60 €**



Grège

Paquet de 60  
**1010689P**



x 4

**P.U.HT**  
**14,60 €**



Mandarine

Paquet de 60  
**1007146P**



x 4

**P.U.HT**  
**14,60 €**

## Isi

Pochette contenant une serviette double point : 38 x 38 cm pliée au format 19 x 9,5 cm, coloris assortis.



A coordonner avec le nappage Lisah page 294



Paquet de 200  
**1006338P** Lagon  
**70348P** Ivoire



**P.U.HT**  
x 1 **35,25 €**  
x 1 **35,25 €**



Paquet de 200  
**70347P** Gris  
**70343P** Blanc



**P.U.HT**  
x 1 **35,25 €**  
x 1 **35,25 €**



Paquet de 200  
**70351P** Vert  
**70346P** Framboise



**P.U.HT**  
x 1 **35,25 €**  
x 1 **35,25 €**

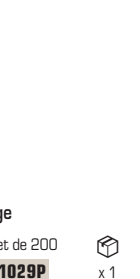

Rouge  
Paquet de 200  
**1001029P**



**P.U.HT**  
x 1 **35,25 €**

## Ecoline

Pochette 8,5 x 20 cm contenant une serviette ovate 2 plis blanche 29 x 39 cm, pliée.



Noir

Paquet de 100  
**1010621P**



x 5

**P.U.HT**  
**11,00 €**



Bordeaux

Paquet de 100  
**1010620P**



x 5

**P.U.HT**  
**11,00 €**



Brun

Paquet de 100  
**1010622P**



x 5

**P.U.HT**  
**11,00 €**



Kivi

Paquet de 100  
**1010623P**



x 5

**P.U.HT**  
**11,00 €**





## Assiette carrée

En polystyrène.



Noir - Sachet de 50  **P.U.HT**  
**62237P** L. 18,5 cm x 8 **9,00 €**  
**62230P** L. 24 cm x 8 **13,00 €**

## Assiette octogonale

En polystyrène.



Noir - Sachet de 50  **P.U.HT**  
**18498P** Ø 18,5 cm x 1 **9,00 €**  
**18500P** Ø 24 cm x 1 **13,00 €**



Blanc - Sachet de 50  **P.U.HT**  
**40318P** Ø 24 cm x 1 **13,00 €**



Couvercle cristal - Sachet de 25  
 Pour assiette Ø 24 cm  **P.U.HT**  
**1006793P** x 8 **7,40 €**



## nouveau !

### Fibre moulée

En pulpe (ou fibre) de canne à sucre. 100% OK Compost, biodégradable au sens de la norme européenne (EN 13432).



Assiette carrée - Sachet de 50  **P.U.HT**  
**1013691P** L. 20 x l. 20 cm x 1 **8,10 €**



Assiette rectangle - Sachet de 40  **P.U.HT**  
**1013692P** L. 28 x l. 20 cm x 1 **8,00 €**



Assiette plate - Sachet de 50  **P.U.HT**  
**1013687P** Ø 18 cm x 1 **4,20 €**  
**1013688P** Ø 23 cm x 1 **7,00 €**  
**1013689P** Ø 26 cm x 1 **8,40 €**



Assiette creuse - Sachet de 50  **P.U.HT**  
**1013690P** Ø 18 cm x 1 **7,20 €**



## Gamme Bagasse

Compostable en milieu industriel.  
 Fabriquée à partir de matériaux renouvelables (fibres de canne à sucre).



Assiette plate - Sachet de 50  **P.U.HT**  
**1007649** Ø 22 cm x 9 **10,30 €**  
**1007650** Ø 18 cm x 8 **5,20 €**



Assiette creuse - Paquet de 50  **P.U.HT**  
**1007651** Ø 16 cm x 10 **6,70 €**

## Assiette carton

Assiette en carton laminé. Format idéal pour les desserts ou la dégustation. Blanc.



Paquet de 100  **P.U.HT**  
**1005759P** Ø 18 cm x 1 **4,10 €**  
**1005758P** Ø 23 cm x 1 **5,70 €**

## Assiette calotte

En PS Blanc. Jusqu'à 80° C. Très bonne rigidité. Contenance optimale.



Sachet de 100  **P.U.HT**  
**48125P** E Ø 12 cm x 1 **3,40 €**  
**58355** E Ø 12,5 cm x 18 **3,60 €**  
**48127P** E Ø 15 cm x 1 **5,00 €**  
**1004470** E Ø 17 cm x 24 **5,80 €**  
**1004469P** E Ø 22 cm x 1 **8,50 €**

## 1<sup>er</sup> PRIX

### Assiette plastique

En PS blanc. 100 % recyclable.



Sachet de 100  **P.U.HT**  
**1002292P** E Ø 17 cm x 1 **3,80 €**  
**1002294P** E Ø 20,5 cm x 1 **4,60 €**  
**1002293P** E Ø 22 cm x 1 **5,40 €**

### Bol

En PS blanc.



Sachet de 50  **P.U.HT**  
**1002295P** E Ø 16,7 x H. 4 cm - 50 cl x 1 **3,50 €**

**Kit couverts métallisés**



Kit composé de : fourchette - couteau  
**1012085** Paquet de 250 x 1 **P.U.HT 111,00 €**



Kit composé de : fourchette - couteau - serviette ouate 2 plis blanche  
**1012086** Paquet de 250 x 1 **P.U.HT 130,00 €**



Kit composé de : fourchette - couteau - cuillère à café - serviette ouate 2 plis blanche  
**1012087** Paquet de 250 x 1 **P.U.HT 151,00 €**



Kit composé de : fourchette - couteau - cuillère à café - serviette ouate 2 plis blanche - sel et poivre  
**1012088** Paquet de 250 x 1 **P.U.HT 166,00 €**



**Kit couverts bois**

Kit 4 en 1, couverts + serviette blanche 2 plis dans un étui en papier kraft brun. Couverts et serviette entièrement biodégradables.



**1011209** E Paquet de 250 x 1 **P.U.HT 89,50 €**

**Kit couverts amidon de maïs**

Sachet couverts luxe trois en un. Résistant à la chaleur. L. 16,5 cm.



Le set de 3 pièces (couteau, fourchette, serviette)  
**1003329** Carton de 500 x 1 **P.U.HT 166,00 €**

**Kit couverts**

En cristal.



Kit composé de : couteau - fourchette - cuillère à dessert - serviette ouate 2 plis blanche.  
**1004283P** Paquet de 250 x 1 **P.U.HT 51,50 €**

**Kit couverts couleur**



Composé de trois couverts en plastique (couteau, fourchette, cuillère à dessert) designé par Philippe Starck et d'une serviette 2 plis de couleur. L. 17,5 cm.



Sachet de 50 **68231P** Argent x 1 **P.U.HT 13,70 €**



Sachet de 50 **68230P** Noir x 1 **P.U.HT 13,70 €**

**1er PRIX**

**Kit couverts blanc**

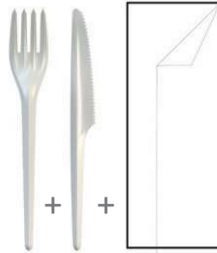

Kit composé de : couteau - fourchette - serviette ouate 2 plis blanche.  
**1011575P** E Paquet de 250 x 1 **P.U.HT 22,25 €**



Kit composé de : couteau - fourchette - cuillère à café - serviette ouate 2 plis blanche.  
**1011574P** E Paquet de 250 x 1 **P.U.HT 23,00 €**



Kit composé de : couteau - fourchette - cuillère à café - serviette ouate 2 plis blanche - sel - poivre.  
**1011576P** Paquet de 250 x 1 **P.U.HT 33,25 €**



**Couverts amidon de maïs**

En amidon de maïs. Résistant à la chaleur. L.16,5 cm.



Ivoire  
 Sachet de 50  
**1004158** E Couteau x 20 **P.U.HT 7,70 €**  
**1004156** E Fourchette x 20 **8,80 €**  
**1004157** E Cuillère x 20 **8,60 €**

**Couverts bois**

Produit entièrement biodégradable.



Paquet de 100  
**1011203** E Fourchette x 25 **P.U.HT 6,40 €**  
**1011202** E Couteau x 25 **5,70 €**  
**1011201** E Cuillère x 25 **6,90 €**  
**1011204** E Petite cuillère x 50 **4,50 €**

**Couverts métallisés**



Boîte de 50  
**1012077** Couteau x 10 **P.U.HT 6,10 €**  
**1012076** Fourchette x 10 **6,10 €**  
**1012075** Cuillère de table x 10 **6,10 €**  
**1012072** Cuillère à café x 20 **4,60 €**

**Couverts Luxe**



En cristal.



Paquet de 50  
**1005067P** Couteau x 1 **P.U.HT 2,70 €**  
**1005066P** Fourchette x 1 **2,70 €**  
**1005065P** Cuillère à dessert x 1 **2,70 €**

Paquet de 100  
**62529P** Cuillère à café x 1 **P.U.HT 2,00 €**

**1er PRIX**

**Couverts**



Paquet de 100  
**1011568P** E Couteau x 1 **P.U.HT 2,50 €**  
**1011567P** E Fourchette x 1 **2,40 €**  
**1011566P** E Cuillère à dessert x 1 **2,50 €**  
**1005000P** Cuillère à café x 1 **1,30 €**

Sachet de 1000  
**1002616P** E Cuillère à café x 2 **P.U.HT 9,80 €**





### Flûte

En PS cristal.



10 cl  
Sachet de 10  
**A 65105P** E Ø 5,5 x H. 17 cm x 1 **P.U.HT 2,50 €**

13,5 cl  
Paquet de 10  
**B 1011556P** E Ø 5,5 x H. 17 cm x 1 **P.U.HT 2,60 €**



### Verre cocktail

En PS cristal.



25 cl  
Sachet de 20  
**A 65107P** E Ø 7 x H. 10 cm x 1 **P.U.HT 2,20 €**

20 cl  
Sachet de 10  
**B 68229P** E Ø 6 x H. 11,5 cm x 1 **P.U.HT 1,60 €**



### Verre à pied

En PS cristal injecté.



17 cl  
Sachet de 12  
**65106P** E Ø 6,2 x H. 10 cm x 1 **P.U.HT 1,60 €**



### Smoothie Huhtamaki



Pour smoothie, jus de fruit, granité dessert ou salade à emporter. **Même diamètre pour toute la gamme, les couvercles s'adaptent à tous les gobelets.**

35 cl - ligné 20 cl  
Paquet de 75  
**1007720P** Ø 9,5 x H. 9,6 cm x 1 **P.U.HT 5,90 €**

40 cl - ligné 30 cl  
Paquet de 67  
**1007721P** Ø 9,5 x H. 10,7 cm x 1 **P.U.HT 6,60 €**

50 cl - ligné 40 cl  
Paquet de 56  
**1007722P** Ø 9,5 x H. 12,7 cm x 1 **P.U.HT 5,90 €**

60 cl - ligné 50 cl  
Paquet de 50  
**1007723P** Ø 9,5 x H. 15,13 cm x 1 **P.U.HT 7,10 €**



Couvercle plat fermé  
Paquet de 64  
**1007744** Ø 9,5 x H. 1,4 cm x 28 **P.U.HT 4,00 €**

Couvercle dôme à trou  
Paquet de 100  
**1007742P** Ø 9,5 x H. 4 cm x 1 **P.U.HT 6,10 €**

Couvercle dôme sans trou  
Paquet de 100  
**1007741P** Ø 9,5 x H. 4 cm x 20 **P.U.HT 6,10 €**

nouveau !



Couvercle plat avec croisillon  
Paquet de 100  
**1013004P** Ø 9,5 cm x 1 **P.U.HT 6,20 €**

### Gobelet lisse



Transparent et brillant. Incassable. 100% recyclable. 1007074P en PET.

30 cl - ligné 25 cl  
Sachet de 50  
**1007074P** Ø 7,8 x H. 10,7 cm x 1 **P.U.HT 3,90 €**

30 cl - ligné 25 cl  
Sachet de 100  
**1002285P** Ø 8 x H. 10,2 cm x 1 **P.U.HT 4,50 €**

35 cl - ligné 30 cl  
Sachet de 50  
**1007075P** Ø 7,8 x H. 12,3 cm x 1 **P.U.HT 4,10 €**

50 cl  
Sachet de 50  
**1014137P** Ø 10,05 x H. 13,5 cm x 1 **P.U.HT 5,50 €**



### Gobelet strié



Transparent  
23 cl - ligné 20 cl  
Sachet de 50  
**1002273P** E Ø 7 x H. 10 cm x 20 **P.U.HT 3,00 €**



Blanc  
Sachet de 100  
**1002392P** E Ø 5,8 x H. 6 cm - 10 cl x 1 **P.U.HT 1,40 €**  
**1002283P** Ø 7,03 x H. 7,2 cm - 15 cl x 1 **2,20 €**  
**1002284P** E Ø 7,3 x H. 8,26 cm - 20 cl x 1 **1,60 €**



Transparent  
23 cl - ligné à 20 cl  
Sachet de 100  
**1002271P** E Ø 4,8 x H. 9,5 cm x 30 **P.U.HT 1,90 €**



Blanc  
23 cl  
Sachet de 100  
**1002270P** E Ø 6,5 x H. 9,5 cm x 30 **P.U.HT 2,00 €**



### Gobelet spécial bière



61 cl - ligné 50 cl  
Sachet de 50  
**1002274P** Ø 9,3 x H. 14 cm x 16 **P.U.HT 4,60 €**

### Gobelet carton

Huhtamaki

En carton avec couche polyéthylène intérieure et extérieure. Panaché de 4 couleurs dans un sachet.



Orange

Vert

30 cl  
Paquet de 100  
**1004161P** Ø 8 x H. 11,8 cm x 20 **P.U.HT 5,70 €**

### Partyclips

Le clip s'accroche à l'assiette et le verre se glisse dans l'anneau.



Paquet de 20  
**1000157P** x 1 **P.U.HT 9,20 €**





### Gobelet Love Nature

Huhtamaki BioWare

100 % biodégradable et compostable. EN 13432. Couche d'étanchéité assurée par un matériau compostable. Couleurs panachées.



<b>Gobelet</b>				
Sachet de 80			<b>P.U.HT</b>	
<b>64367P</b>	E Ø 6,2 x H. 6,4 cm - 10 cl	x 1	<b>6,00 €</b>	
<b>Gobelet</b>				
Paquet de 100			<b>P.U.HT</b>	
<b>1000359P</b>	E Ø 7 x H. 8 cm - 15 cl	x 1	<b>12,00 €</b>	
<b>1001461P</b>	E Ø 7 x H. 9,3 cm - 20 cl	x 1	<b>12,10 €</b>	

### Gobelet Hot cup Huhtamaki

En carton avec couche polyéthylène intérieure et extérieure. Gobelet résistant et étanche.



<b>Paquet de 80</b>				
	<b>1002412P</b>	Ø 6,2 x H. 6,4 cm - 10 cl	x 1	<b>P.U.HT</b>
		(Couvercle 1007063)		<b>3,30 €</b>



<b>Paquet de 100</b>				
	<b>1002413P</b>	Ø 7 x H. 8 cm - 15 cl	x 1	<b>P.U.HT</b>
		(Couvercle 1002417)		<b>4,70 €</b>



<b>Paquet de 100</b>				
	<b>1002415P</b>	Ø 7 x H. 9,3 cm - 18 cl	x 1	<b>P.U.HT</b>
		(Couvercle 1002417)		<b>5,50 €</b>



<b>Paquet de 50</b>				
	<b>1007717P</b>	Ø 8 x H. 9,15 cm - 20 cl	x 1	<b>P.U.HT</b>
		(Couvercle 1002416)		<b>2,80 €</b>



<b>Paquet de 55</b>				
	<b>1002414P</b>	Ø 8 x H. 11,6 cm - 30 cl	x 1	<b>P.U.HT</b>
		(Couvercle 1002416)		<b>4,90 €</b>



<b>Couvercle pour gobelet Hot Cup</b>				
Paquet de 100				
	<b>A 1007063P</b>	Ø 6,2 cm pour 10 cl	x 1	<b>P.U.HT</b>
	<b>B 1002417P</b>	Ø 7 cm pour 15/18 cl	x 1	<b>4,10 €</b>
	<b>B 1002416P</b>	Ø 8,3 cm pour 20/30 cl	x 1	<b>4,50 €</b>



### Gobelet double paroi

Huhtamaki

Gobelet double paroi, couleur Kraft.



<b>Paquet de 25</b>				
	<b>1014114P</b>	Ø 6,3 x H. 6,4 cm - 10 cl	x 20	<b>P.U.HT</b>
				<b>2,90 €</b>
<b>Paquet de 37</b>				
	<b>1007718P</b>	Ø 8 x H. 9,15 cm - 20 cl	x 25	<b>P.U.HT</b>
				<b>4,80 €</b>

### Tasse



En PS. Avec anse pour faciliter la prise en main sans se brûler.



<b>Noir - blanc</b>				
	<b>1004153P</b>	E 10 cl - Paquet de 100	x 20	<b>P.U.HT</b>
				<b>5,00 €</b>



<b>Marron - blanc</b>				
	<b>1011557P</b>	E 18 cl - Paquet de 50	x 20	<b>P.U.HT</b>
				<b>4,70 €</b>



<b>Blanc</b>				
	<b>61141P</b>	10 cl - Paquet de 50	x 30	<b>P.U.HT</b>
	<b>1004172P</b>	20 cl - Paquet de 50	x 20	<b>2,10 €</b>
				<b>3,60 €</b>



<b>Blanc</b>				
	<b>1005074P</b>	E 15 cl - Paquet de 40	x 20	<b>P.U.HT</b>
				<b>2,50 €</b>



### Agitateur bois



<b>1011564P</b>	L. 14 cm - Paquet de 1000	x 1	<b>P.U.HT</b>
<b>1011565P</b>	L. 11cm - Paquet de 5000	x 1	<b>4,90 €</b>
			<b>16,25 €</b>



### Agitateur

En PS blanc.



<b>Sachet de 1000</b>				
	<b>48134P</b>	L. 11,2 cm	x 1	<b>P.U.HT</b>
				<b>5,90 €</b>



### Distributeur agitateurs

Boîte en carton.



<b>Boîte de 1500</b>				
	<b>48135P</b>	E L. 11 cm	x 1	<b>P.U.HT</b>
				<b>8,90 €</b>

### SUCRE



### Naturel et coloré



S'utilise à chaud et à froid pour la pâtisserie, les cocktails et la restauration.

<b>480 buchettes de 4 g</b>				
	<b>64791P</b>	Naturel	x 1	<b>P.U.HT</b>
				<b>32,75 €</b>

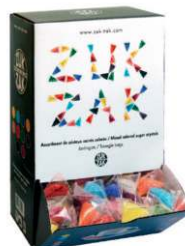

<b>380 berlingots de 4 g</b>				
	<b>64792P</b>	Naturel	x 1	<b>P.U.HT</b>
	<b>64789P</b>	Coloré	x 1	<b>32,75 €</b>
				<b>37,00 €</b>





## Kit plateau repas



Plateau fond noir 5 compartiments dont 1 dédié aux accessoires (verre, couverts, pain) et couvercle cristal anti-buée forme ludique avec ses dômes ronds successifs. Comprend 1 ravier "dessert", 2 ravier "entrée", et 1 ravier principal. Plats isolés les uns des autres. Stabilité en empilabilité du plateau fermé pour le transport. Kits fonds + couvercles dans le même carton.

Paquet de 20  
**70469P** L. 39 x l. 25 x H. 8 cm x 1 **P.U.HT 37,75 €**



## Kit plateau repas Prestige



Vaisselle blanche. Couvercle cristal cloisonné préservant saveurs et arômes de chaque plat. Fond en PS, ravier en PP et couvercle en OPS. Température d'utilisation -5 à + 80°C.

Kit plateau repas 5 compartiments

Paquet de 15  
**62588P** E L. 42 x l. 26,4 x H. 6,5 cm - Bordeaux x 4 **P.U.HT 30,00 €**



Kit plateau repas 7 compartiments - Noir

**59496P** L. 42 x l. 32,6 x H. 6 cm x 30 **P.U.HT 3,00 €**



Kit plateau repas 7 compartiments - Bordeaux

**59497P** L. 42 x l. 32,6 x H. 6 cm x 30 **P.U.HT 3,00 €**



nouveau !



## Fibre moulée

En fibre et pulpe de canne à sucre. 5 compartiments. 100 % OK Compost, biodégradable au sens de la norme européenne (EN 13432).

Plateau 5 compartiments

Paquet de 50  
**1013703P** L. 30 x l. 24 x H. 4 cm x 1 **P.U.HT 17,00 €**

Couvercle

Paquet de 50  
**1013704P** L. 31 x l. 25 x H. 3 cm x 1 **P.U.HT 11,00 €**



## Plateau repas



Plateaux en PS blanc, couvercles en PET transparent clipsables. Empilables même remplis.

Plateau repas 5 compartiments GN 1/2

Sachet de 50  
**44706P** L. 32 x l. 26 x H. 3,5 cm x 1 **P.U.HT 27,00 €**

Couvercle GN 1/2

Sachet de 25  
**31014P** L. 32,4 x l. 26,4 x H. 5 cm x 1 **P.U.HT 10,00 €**

Plateau repas 5 compartiments

Sachet de 50  
**48198P** E L. 29 x l. 22,4 x H. 3 cm x 1 **P.U.HT 16,25 €**

Couvercle

Sachet de 50  
**58322P** E L. 29,7 x l. 23,1 x H. 5 cm x 1 **P.U.HT 15,75 €**





nouveau !

## Palette bois solia



Code	Dimensions	Quantité	P.U. HT
1013634	L. 40 x l. 30 x H. 4,1 cm	x 4	9,10 €
1013635	L. 30 x l. 20 x H. 3,4 cm	x 10	5,10 €

## Plateau traiteur



Carton contre collé d'un film métallisé sur une face. Dessous blanc, dessus couleur or ou argent. 1200 g/m<sup>2</sup>. Dégraissable.



Face or	Paquet de 25	Quantité	P.U. HT
61493P	E L. 42 x l. 28 cm.	x 4	12,80 €



Face argent	Paquet de 25	Quantité	P.U. HT
61492P	E L. 42 x l. 28 cm.	x 4	12,80 €

## Rond traiteur

Rond en carton extra fort double face or/noir.



Paquet de 100	Dimensions	Quantité	P.U. HT
1011205	Ø 20 cm	x 1	11,70 €
1011206	Ø 26 cm	x 1	20,50 €
1011207	Ø 34 cm	x 1	41,25 €

## Boîte traiteur

En carton blanc.



Paquet de 25	Dimensions	Quantité	P.U. HT
47670P	E L. 42,5 x l. 28,5 x H. 6 cm	x 1	17,25 €

## Caisse traiteur

En carton.



Paquet de 25	Dimensions	Quantité	P.U. HT
58356P	L. 64 x l. 42 x H. 10 cm	x 1	22,00 €

## Ravier

Ravier blanc sans film PE, en carton extra fort.



Paquet de 250	Dimensions	Quantité	P.U. HT
1011211	L. 20 x l. 13 cm	x 6	10,40 €

Ravier blanc avec film PE ingraissable, en carton extra fort.



Paquet de 250	Dimensions	Quantité	P.U. HT
1011212	L. 18 x l. 13 cm	x 4	20,00 €

## Carré rainé



Support en carton blanc, pour gâteaux, tartes sucrées et salées, pizzas, quiches.



Paquet de 250	Dimensions	Quantité	P.U. HT
1005646	L. 13 x l. 13 cm	x 1	4,00 €

## Rond festonné blanc

En carton épaisseur 400 g/m<sup>2</sup>.



Paquet de 250	Dimensions	Quantité	P.U. HT
49045P	Ø 32 cm	x 1	22,25 €

## DENTELLES

### Dentelle

En papier blanc.

Ronde

Paquet de 250	Dimensions	Quantité	P.U. HT
1000343P	Ø 10 cm	x 1	4,10 €
1000344P	Ø 12 cm	x 1	4,70 €
1000345P	Ø 15 cm	x 1	6,00 €
1000346P	Ø 17 cm	x 1	6,50 €
1000347P	Ø 19 cm	x 1	7,40 €
1000348P	Ø 21 cm	x 1	9,20 €
1000349P	Ø 23 cm	x 1	10,20 €
1000350P	Ø 25 cm	x 1	11,20 €
1000351P	Ø 28 cm	x 1	13,80 €
1000352P	Ø 30 cm	x 1	16,00 €

Ovale

Paquet de 250	Dimensions	Quantité	P.U. HT
49517P	L. 24 x l. 17 cm	x 1	7,20 €
1000357P	L. 30 x l. 22 cm	x 1	21,00 €

Rectangulaire

Paquet de 250	Dimensions	Quantité	P.U. HT
1000353P	L. 35 x l. 26 cm	x 1	18,25 €
1000354P	L. 40 x l. 30 cm	x 1	20,00 €
1000355P	L. 45 x l. 35 cm	x 1	25,00 €





### Pipette

En polyéthylène.

Paquet de 100  
**1001497P**

Ø 1,5 x H. 9 cm  
- 0,4 cl



x 1

P.U.HT  
**9,10 €**

**solia**

### 1<sup>er</sup> PRIX



### Tubby



Paquet de 60

**1004248P**

Ø 4 x H. 5,5 cm - 3,5 cl



x 8

P.U.HT  
**6,50 €**



### Carrée



Paquet de 50

**70474P**

L. 6 x l. 6 x  
H. 1,4 cm - 2 cl



x 10

P.U.HT  
**8,10 €**

### nouveau !

### Soupière

Noire et dorée

**solia**



Paquet de 24

**1013625**

Ø 6,1 x H. 5,9 cm - 4,5 cl



x 5

P.U.HT  
**21,25 €**

### nouveau !

### Poêle

Noire et dorée.

**solia**



Paquet de 24

**1013624**

Ø 5,5 x H. 2,5 cm -  
3,05 cl



x 10

P.U.HT  
**10,00 €**

### Casserole

Noire et dorée

**solia**



Paquet de 24

**1013623**

Ø 5 x H. 4,1 cm - 4,5 cl



x 10

P.U.HT  
**11,70 €**



### Bol thai

Panaché de 5 couleurs.

**solia**



Paquet de 100

**1004245P**

E Ø 5 x H. 2,8 cm -  
3 cl



x 10

P.U.HT  
**24,50 €**

Paquet de 24

**1013623**

Ø 5 x H. 4,1 cm - 4,5 cl



x 10

P.U.HT  
**11,70 €**

### 1<sup>er</sup> PRIX

### Le cinq



Paquet de 50

**1003743P**

Ø 4,4 x H. 5 cm - 5 cl



x 12

P.U.HT  
**7,50 €**

### nouveau !

### Coquille d'œuf

Véritables coquilles d'œufs, découpées au laser et traitées thermiquement pour stérilisation.

**solia**



Paquet de 18

**1013620**

Ø 4,5 x H. 4,9 cm - 5 cl



x 18

P.U.HT  
**25,00 €**

### Cuillère



Paquet de 60

**1004253P**

E L. 8,3 x l. 3,3 cm



x 8

P.U.HT  
**9,60 €**

### Cuillère cristal



Paquet de 50

✓ **1003742P**

L. 12 x l. 4,2 cm



x 6

P.U.HT  
**7,00 €**



1<sup>er</sup> PRIX



## Schnaps



Paquet de 50  
58763P Ø 4,3 cm x  
H. 5,2 cm - 5 cl



P.U.HT  
2,50 €



## Diams

En APET coloris noir.

**solia**

Paquet de 40  
1004241P Ø 5,7 x H. 4 cm -  
7,5 cl



P.U.HT  
23,00 €



## Tulipe



Paquet de 60  
1004252P E Ø 6,3 x H. 5 cm - 6 cl



P.U.HT  
11,50 €



## Verre carré



Paquet de 60  
1004251P E L. 3,5 x l. 3,5 x  
H. 6,1 cm - 7,5 cl



P.U.HT  
11,50 €

nouveau !



## Bol Tulip'

Noir et doré.



Paquet de 20  
1013621 Ø 5,7 x H. 3,9 cm - 6,5 cl x 12  
1013622 Ø 7,5 x H. 5,3 cm - 16,5 cl x 12



P.U.HT  
8,30 €  
9,30 €



## Sph'air

En APET.

**solia**

Paquet de 40  
1004243P Ø 5,7 x H. 4 cm -  
7,5 cl



P.U.HT  
18,00 €

Paquet de 20  
1004242P Ø 7 x H. 5 cm -  
15 cl



P.U.HT  
14,30 €



## Saladier



Paquet de 60  
1004250P E Ø 6,7 x H. 3,1 cm - 7,5 cl x 10



P.U.HT  
11,50 €



## Cube



Paquet de 100  
1003707P L. 4,7 x l. 4,7 x  
H. 4,5 cm - 6 cl



P.U.HT  
16,25 €



## Sph'air goutte

En APET.

**solia**

Paquet de 40  
1004244 Ø 5,8 x H. 6,2 cm -  
11,5 cl



P.U.HT  
24,25 €



## Bizo



Paquet de 60  
1004254P E Ø 3,1 x H. 6 cm - 6 cl



P.U.HT  
11,50 €



## Verre conique



Paquet de 100  
1004261P Ø 8 x H. 5 cm - 15 cl



P.U.HT  
28,25 €

MISES EN BOUCHE



USAGE UNIQUE

nouveau !

## Bodega

**solia** PS  
POLYSTYRÈNE



Paquet de 8  
**1013637P** Ø 6,5 x H. 4,7 cm - 12 cl

x 25

P.U.HT  
**1,10 €**



Carton de 200  
**1013638** Ø 7 x H. 0,5 cm

x 1

P.U.HT  
**11,90 €**

## Bodega

**ALPHA** PS  
POLYSTYRÈNE



Pot + couvercle  
Paquet de 30  
**1006315P** E Ø 8 x H. 6,3 cm - 18 cl

x 10

P.U.HT  
**8,50 €**



## Rmes

PS  
POLYSTYRÈNE

Paquet de 10  
**1003744P** L. 5,5 x l. 5,5 x  
H. 8 cm - 16 cl

x 20

P.U.HT  
**3,50 €**



## Emeraude

**solia** PS  
POLYSTYRÈNE

Paquet de 100  
**1004264P** Ø 6,5 x l. 6,5 x  
H. 6 cm - 15,5 cl

x 6

P.U.HT  
**27,50 €**



## Tube tronqué

**solia** PS  
POLYSTYRÈNE

Paquet de 50  
**1004259P** Ø 5 x H. 11 cm - 16 cl

x 6

P.U.HT  
**24,50 €**



## Féria

**ALPHA** PS  
POLYSTYRÈNE

Paquet de 30  
**1004171P** Ø 8,3 x H. 6 cm - 25 cl

x 10

P.U.HT  
**9,20 €**

nouveau !

## Cagette

En bois.

**solia**



Paquet de 10  
**1013629** L. 8 x l. 5 x H. 4 cm

x 9

P.U.HT  
**14,50 €**

## Bouteille Perette

En PET.

**solia**



Paquet de 100  
**1007591** Ø 5,5 x H. 14 cm - 25 cl

x 1

P.U.HT  
**64,00 €**

Bouchon aluminium  
**1007592** Paquet de 100

x 1

P.U.HT  
**33,00 €**

nouveau !

## Palette

En bois.

**solia**



**1013634** L. 40 x l. 30 x H. 4,1 cm  
**1013635** L. 30 x l. 20 x H. 3,4 cm

x 4  
x 10

P.U.HT  
**9,10 €**  
**5,10 €**

Paquet de 10  
**1013636** L. 8 x l. 6 x H. 1,7 cm

x 18

**11,60 €**





## Cuillère

En PS métallisé.

Paquet de 100  
**1012080** L. 10 cm

x 10



P.U.HT  
**7,30 €**



Boule bleu, jaune, rouge et vert

Paquet de 200  
**70290P** L. 15 cm

x 1

P.U.HT  
**9,10 €**



## Fourchette

En PS métallisé.

Paquet de 100  
**1012079** L. 10 cm

x 10



P.U.HT  
**7,30 €**



## Pique

Pour les cocktails.

Golf

Paquet de 250  
✓ **61342P** L. 9 cm  
✓ **61343P** L. 15 cm

x 1  
x 1

P.U.HT  
**8,30 €**  
**10,20 €**



## Cuillère

PS cristal.

Sachet de 250  
✓ **64524P** L. 10 cm

x 20



P.U.HT  
**5,10 €**



Ruban

Paquet de 500  
✓ **1002346P** L. 6 cm

x 1

P.U.HT  
**13,60 €**



## Fourchette

PS cristal.

Sachet de 250  
**64525P** L. 10 cm

x 20



P.U.HT  
**5,60 €**

Paquet de 200  
✓ **63507P** L. 9 cm

x 1

P.U.HT  
**5,80 €**



## Pique

Pique brochette apéritive en bambou.

**solia**

Cercle rouge et blanc

Paquet de 200  
**1006373P** L. 12 cm

x 1

P.U.HT  
**12,80 €**



Fleur

Paquet de 250  
**1002342P** L. 12 cm

x 1

P.U.HT  
**14,50 €**



Noir et rouge

Paquet de 200  
**70287P** L. 12 cm

x 1

P.U.HT  
**11,70 €**



Boule rouge

Paquet de 500  
✓ **1002344P** L. 12 cm

x 1

P.U.HT  
**22,75 €**

nouveau !



Trident

Paquet de 100  
**1013628** L. 8,5 cm

x 20

P.U.HT  
**5,60 €**



Pêcheur

Paquet de 100  
**1013626** L. 12 cm

x 20

P.U.HT  
**14,00 €**



Boucle

Paquet de 100  
**1013627** L. 17 cm

x 20

P.U.HT  
**5,90 €**



## Pique

En PS.

Carton de 100  
**1002347P** L. 9 cm

x 1

P.U.HT  
**1,60 €**

## Pique bois

Boite de 1000

1 pointe  
✓ **65089P** L. 6,5 cm

x 1

P.U.HT  
**2,60 €**

2 pointes  
✓ **1002343P** L. 8 cm

x 1

P.U.HT  
**3,30 €**



## Cure dents

Matériau plastique. Pointe biseautée. Emballés individuellement.

Paquet de 1000  
✓ **65092P**

x 1

P.U.HT  
**15,75 €**



## BURGER

### Boîte burger

Boîte hamburger carton au look naturel. Structure en micro-cannelures assurant en outre une bonne tenue en température.

**solia**



Paquet de 50

**1011335P** L. 14 x l. 14 x H. 7 cm  
**1011334P** L. 17 x l. 17 x H. 8 cm

x 1  
x 1

**P.U.HT**  
**8,60 €**  
**14,10 €**

### Papier ingraissable burger

Papier impression «journal» enduit une face. Ce papier est spécialement conçu pour l'emballage des burgers. Epaisseur 40 g/m<sup>2</sup>.



Paquet de 900

**1008452P** L. 33 x l. 40 cm

x 1

**P.U.HT**  
**23,00 €**

## FRITES



A



B



### Barquette

Barquette kraft intérieur blanc.

Paquet de 500

A **1011530P** 40 cl - L. 15,5 x l. 8,5 x H. 3,7 cm

**Huhtamaki**

x 1

**P.U.HT**  
**38,25 €**

### Pochette frites

Pochette kraft intérieur blanc.

Paquet de 1000

B **1011532P** 45 cl - L. 13,5 x l. 5,8 x H. 9,8 cm  
B **1011531P** 40 cl - L. 12 x l. 5 x H. 8,5 cm

**Huhtamaki**

x 10  
x 10

**P.U.HT**  
**77,50 €**  
**70,00 €**

### Pot à sauce

En APET. Utilisation froide.

**ALPHA**

Sachet de 100

**1001609P** Ø 7,3 x H. 2,3 cm - 5 cl  
**1001610P** Ø 7,3 x H. 4 cm - 8 cl  
**1001611P** Ø 7,3 x H. 4,9 cm - 10 cl  
**1001612P** Ø 7,3 x H. 5,8 cm - 12,5 cl  
**1001613P** Couvercle Ø 7,5 cm

x 1  
x 1  
x 1  
x 1  
x 1

**P.U.HT**  
**5,50 €**  
**5,30 €**  
**5,50 €**  
**5,60 €**  
**4,20 €**

nouveau !

### Papier ingraissable pour cornet ou panier à frites

Papier ingraissable brun impression journal.



Paquet de 1000

**1014119P** L. 25 x l. 20 cm

x 1

**P.U.HT**  
**11,50 €**



### Pot à sauce Bagasse

Compostable en milieu industriel.

Fabriquée à partir de matériaux renouvelables (fibres de canne à sucre).

**Duni**



Paquet de 150

**1007694P** Ø 6,3 x H. 1,8 cm - 5 cl  
**1007695** Ø 6,3 x H. 3,2 cm - 6 cl

x 10  
x 10

**P.U.HT**  
**5,70 €**  
**7,80 €**

## WRAP / TORTILLA



### Wrap

Pot carton kraft pour wrap.

Paquet de 50

**1011333P** Ø 8 x H. 12 cm

x 1

**P.U.HT**  
**7,90 €**

**solia**



## SANDWICHS



### Sac sandwich en papier ingraissable

Paquet de 1000  
✓ **1004164P** L. 35 x l. 10 + 5 cm

☐ x 1



**P.U.HT**  
**25,00 €**

### Sac sandwich en papier à fenêtre Oléane

Paquet de 1000  
**1004168P** L. 35 x l. 10 + 5,5 cm

☐ x 1



**P.U.HT**  
**30,25 €**

nouveau !



### Sac sandwich Bago

Cellophane transparent. 23 µ.

Paquet de 500  
**1013371P** L. 34 x l. 10 cm

☐ x 2

**P.U.HT**  
**50,25 €**

### Sac sandwich

50 µ, impression 4 couleurs.

Paquet de 500  
**1013374P** L. 35 x l. 14 cm

☐ x 2

**P.U.HT**  
**21,75 €**



### Sac sandwich

En papier cristal. 100% recyclable.

Paquet de 1000  
**71170P** L. 35 x l. 10 cm

☐ x 1

**P.U.HT**  
**54,50 €**

nouveau !



### Sac sandwich Grill Bag

Qualité papier cuisson, kraft brun.

Paquet de 600  
**1013373P** L. 32 x l. 10,5 cm + soufflet 4 cm

☐ x 1

**P.U.HT**  
**78,00 €**



### Sac sandwich

En papier cristal.

Paquet de 500  
**49036P** L. 40 x l. 15 cm

☐ x 2

**P.U.HT**  
**32,75 €**

## CROISSANTS

### Sac croissants

En kraft blanc avec décor.



Paquet de 1000  
✓ **1004166P** L. 26 x l. 14 + 7 cm

☐ x 1

**P.U.HT**  
**27,50 €**



nouveau !

### Sac viennoiseries

En papier kraft blanc, pour viennoiseries, confiseries...



Carton de 1000  
**1013370** L. 30 x l. 17 cm + soufflet 7 cm  
**1013369** L. 27 x l. 14 cm + soufflet 7 cm  
**1013368** L. 21 x l. 14 cm + soufflet 7 cm

☐ x 1  
☐ x 1  
☐ x 1

**P.U.HT**  
**18,25 €**  
**15,00 €**  
**12,40 €**



## POTS



### Pot kraft

Fabriqué à partir de matériaux éco-responsables. Idéal pour les soupes, salades ou frozen yogurts.

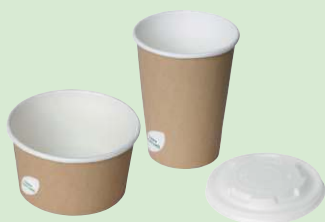

Pot - Paquet de 50		P.U.HT
<b>1011219P</b>	Ø 9 x H. 6,2 cm - 25 cl x 8	<b>5,70 €</b>
<b>1011221P</b>	Ø 11,5 x H. 6,3 cm - 40 cl x 10	<b>8,60 €</b>
<b>1011222P</b>	Ø 11,5 x H. 7,7 cm - 55 cl x 10	<b>8,60 €</b>
<b>1011223</b>	Ø 11,5 x H. 14,8 cm - 95 cl x 10	<b>11,80 €</b>

Couvercle - Paquet de 50		P.U.HT
<b>1011220P</b>	Pour pot 25 cl x 16	<b>5,70 €</b>
<b>1011224P</b>	Pour pot 40/55/95 cl x 16	<b>9,40 €</b>



### Pot

En carton/PE. Idéal pour les soupes, salades ou pâtes.



Bol Paquet de 50		P.U.HT
<b>1011225P</b>	Ø 9 x H. 6,2 cm - 25 cl x 8	<b>4,70 €</b>
<b>1011227P</b>	Ø 11,5 x H. 6,3 cm - 40 cl x 10	<b>6,40 €</b>
<b>1011228P</b>	Ø 11,5 x H. 7,7 cm - 55 cl x 10	<b>7,00 €</b>

Paquet de 46		P.U.HT
<b>1011235</b>	Ø 18,4 x H. 6,5 cm - 126 cl x 6	<b>18,50 €</b>

### Pot

Pour produits chauds. Passage au four à micro-ondes pour réchauffage des aliments.



Paquet de 50		P.U.HT
<b>1011352P</b>	Ø 10,1 x H. 4,8 cm - 23,5 cl x 1	<b>3,10 €</b>
<b>1011353P</b>	Ø 10,1 x H. 10,4 cm - 50 cl x 1	<b>4,30 €</b>

Couvercle		P.U.HT
<b>1011354P</b>	Pour pots 23,5 et 50 cl x 1	<b>2,00 €</b>

### Pot Tussipack

En APET. Utilisation froide.



Sachet de 50		P.U.HT
<b>1001638P</b>	Ø 11,7 x H. 4,3 cm - 25 cl x 1	<b>4,90 €</b>
<b>1001639P</b>	Ø 11,7 x H. 5,7 cm - 35 cl x 1	<b>5,80 €</b>
<b>1001640P</b>	Ø 11,7 x H. 8,1 cm - 50 cl x 1	<b>7,10 €</b>
<b>1001641P</b>	Ø 11,7 x H. 11,6 cm - 75 cl x 1	<b>10,80 €</b>
<b>1001642</b>	Ø 11,7 x H. 15,6 cm - 100 cl x 10	<b>12,00 €</b>
<b>1001643P</b>	Couvercle Ø 12,2 cm x 1	<b>3,00 €</b>



Couvercle transparent Paquet de 50		P.U.HT
<b>1011226P</b>	Ø 9,5 cm - Bol 25 cl x 1	<b>2,10 €</b>
<b>1011230P</b>	Ø 12 cm - Bol 40 / 55 / 95 cl x 1	<b>3,90 €</b>

Paquet de 80		P.U.HT
<b>1011236</b>	Ø 19 cm - Bol 126 cl x 4	<b>13,90 €</b>

## PÂTES

### Pot à pâtes blanc

Pot à pâtes en carton avec couche en polyéthylène.



Paquet de 500		P.U.HT
<b>1007691P</b>	50 cl x 1	<b>69,50 €</b>
<b>1004188P</b>	75 cl x 1	<b>93,00 €</b>



### Pot à pâtes décoré

Pot à pâtes en carton avec couche en polyéthylène. Décor standard avec couteau et fourchette sur base blanche.

Carton de 500		P.U.HT
<b>1007148P</b>	50 cl x 1	<b>82,00 €</b>
<b>1004185P</b>	75 cl x 1	<b>94,50 €</b>
<b>1004186P</b>	100 cl x 1	<b>128,00 €</b>

## PIZZA

### Part pizza

Support individuel pour part pizza et autres.



Paquet de 250		P.U.HT
<b>1004163P</b>	L. 19 x l. 17 x H. 2 cm x 1	<b>13,80 €</b>



### Boîte à pizza

Boîte à pizza en carton ondulé.

Carton de 100		P.U.HT
<b>1004192P</b>	L. 29 x l. 29 cm. H. 4 cm x 1	<b>26,00 €</b>
<b>1004193P</b>	L. 33 x l. 33 cm. H. 4 cm x 1	<b>29,50 €</b>

nouveau !

### Sac isotherme

Sac de livraison conçu spécialement pour les livraisons professionnelles d'aliments chauds et froids. Fabriqué en nylon résistant. Large fenêtre transparente pour étiquette. Système de fermeture et poignées Velcro. Boucle d'accroche pour séchage et rangement. Système spécifique d'œillets, qui améliore la performance thermique des sacs en utilisation intensive. La vapeur est libérée efficacement et l'humidité est nettement réduite.



4 pizzas de 40 cm		P.U.HT
<b>1013301P</b>	L. 54,6 x l. 50,1 x H. 19,6 cm x 1	<b>68,50 €</b>



6 pizzas de 40 cm		P.U.HT
<b>1013302P</b>	L. 50,1 x l. 50,1 x H. 33 cm x 1	<b>96,50 €</b>





## DESSERTS



### Tarte

Part de tarte individuelle (sucrée/salée) avec fond et couvercle.

Paquet de 30

**1006211** L. 11,9 x l. 11,9 x H. 3,5 cm

x 24

P.U.HT  
**4,70 €**



### Part de tarte

Avec couvercle. Pour les préparations salées ou sucrées.

Sachet de 90

**64794P** 45 cl - L. 16,2 x l. 13,5 x H. 5 cm

x 1

P.U.HT  
**20,00 €**



### Tarte

Barquette carton avec couvercle attachant à fenêtre.

Paquet de 50

**1011330P** L. 12 x l. 12 x H. 4 cm

x 1

P.U.HT  
**22,50 €**

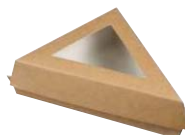

### Part de tarte

Barquette carton à fenêtre.

Paquet de 50

**1011331** L. 15,5 x l. 15,5 x H. 4,5 cm

x 10

P.U.HT  
**21,25 €**



nouveau !



A



B



C



D



E

### Pot à dessert

En APET.



Pot - Paquet de 50

A **1013499P** 20 cl - Ø 8,5 x H. 6,6 cm

x 1

P.U.HT  
**3,80 €**

Couvercle dôme sans trou pour Ø 8,5 cm - Paquet de 50

A **1013500** Ø 8,5 x H. 3,6 cm

x 10

**3,30 €**

Pot - Paquet de 50

B **1013504** 20,5 cl - Ø 9,5 x H. 5,3 cm

x 16

P.U.HT  
**5,40 €**

Couvercle dôme sans trou pour Ø 9,5 cm - Paquet de 50

B **1013507** Ø 10,1 x H. 2,7 cm

x 32

**2,00 €**

Pot - Paquet de 50

C **1013505** 30 cl - Ø 9,5 x H. 8 cm

x 16

P.U.HT  
**6,40 €**

C **1013506** 40 cl - Ø 9,5 x H. 11,1 cm

x 16

**7,50 €**

Couvercle plat pour Ø 9,5 cm - Paquet de 50

C **1013509** Ø 10,1 x H. 1,24 cm

x 32

**1,70 €**

Insert pour Ø 9,5 cm - Paquet de 50

D **1013508** Ø 8,35 x H. 2,2 cm

x 32

**0,95 €**

Pot - Paquet de 50

E **1013502** 25 cl - Ø 7,6 x H. 9,3 cm

x 20

P.U.HT  
**4,10 €**

E **1013501** 20 cl - Ø 7,6 x H. 8 cm

x 20

**4,10 €**

Couvercle plat pour Ø 7,6 cm - Paquet de 50

E **1013503** Ø 8,1 x H. 1,24 cm

x 20

**1,40 €**

### Coupe à dessert



Sachet de 25 coupes

**65080P** Ø 9,5 x H. 6,1 cm - 20 cl

x 1

P.U.HT  
**2,80 €**

Sachet de 50 couvercles dôme

**65081P** Ø 10 x H. 3 cm

x 1

P.U.HT  
**3,70 €**





## Barquette charcutière

En PS. Translucide.



### Fond plat

Code	Description	Quantité	P.U. HT
3791	L. 7,5 x l. 6,5 x H. 3 cm - 7,5 cl - Paquet de 500	x 10	5,70 €
3792	L. 9,2 x l. 6,2 x H. 3,2 cm - 10 cl - Paquet de 500	x 12	5,90 €
3793P	E L. 9,1 x l. 7,1 x H. 3,5 cm - 12,5 cl - Paquet de 500	x 1	6,30 €
3794P	E L. 11,3 x l. 6,7 x H. 3,4 cm - 15 cl - Paquet de 500	x 1	8,00 €
3795	E L. 11,2 x l. 8,8 x H. 3,3 cm - 20 cl - Paquet de 500	x 6	9,40 €
3796P	E L. 11,1 x l. 8,7 x H. 4,2 cm - 25 cl - Paquet de 500	x 1	10,40 €
3797P	E L. 13,8 x l. 9 x H. 4,6 cm - 37,5 cl - Paquet de 250	x 1	6,20 €

### Fond ondulé

Code	Description	Quantité	P.U. HT
53034	L. 11,1 x l. 8,1 x H. 4,2 cm - 25 cl - Paquet de 500	x 6	12,10 €
3799P	E L. 14,3 x l. 11,1 x H. 4,9 cm - 50 cl - Paquet de 250	x 1	8,90 €
4000P	E L. 17,6 x l. 11,6 x H. 4,9 cm - 70 cl - Paquet de 250	x 1	13,10 €
4001P	E L. 18,9 x l. 14,4 x H. 5,4 cm - 100 cl - Paquet de 250	x 1	17,00 €

## Ravier à fond plat

En PS.



### Paquet de 250

Code	Description	Quantité	P.U. HT
48237	L. 13,7 x l. 9,5 x H. 2,5 cm - 22 cl	x 12	7,70 €

## Moule pour oeuf

PS Cristal.



### Paquet de 150

Code	Description	Quantité	P.U. HT
58323P	L. 8,6 x l. 6,6 x H. 3,4 cm - 9 cl	x 1	7,40 €

## Petite coquille

En pulpe de canne à sucre. Entièrement biodégradable. Résiste à la chaleur, au four et au micro-ondes.

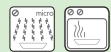

### Paquet de 50

Code	Description	Quantité	P.U. HT
1011218	Ø 12 x L. 11,4 x H. 2,9 cm - 150 ml	x 10	9,10 €

## Caissette translucide ronde

En PS.



### Boîte de 1000

Code	Description	Quantité	P.U. HT
44722P	Ø 9,2 x H. 2,7 cm - 12 cl	x 4	31,50 €





## Takipack



En PS avec couvercle en OPS. Le contenu est valorisé grâce au large champ de vision du couvercle.

### Sachet de 30

<b>1004331</b>	90 cl - L. 23,1 x l. 17,1 x H. 4,6 cm
<b>1013513</b>	85 cl - L. 17,7 x l. 17,7 x H. 4 cm

	P.U.HT
x 12	<b>14,20 €</b>
x 12	<b>10,30 €</b>



## Boîte fraîcheur multi-positions Sekipack



En APET. Non micro-ondable. Accepte des plats chauds jusqu'à 70° C. Etanche. Couvercle déchirable pour une dégustation à même la boîte. De -40° C à +70° C.

<b>49334P</b>	25 cl - Ø 12 x H. 7 cm - Sachet de 60
<b>66333P</b>	37,5 cl - Ø 13,7 x H. 8 cm - Sachet de 50
<b>44542P</b>	50 cl - Ø 15,5 x H. 8,5 cm - Sachet de 50
<b>44543P</b>	75 cl - Ø 17,5 x H. 9,5 cm - Sachet de 50
<b>48277P</b>	100 cl - Ø 18,5 x H. 10,2 cm - Sachet de 50

	P.U.HT
x 1	<b>7,10 €</b>
x 6	<b>9,50 €</b>
x 1	<b>11,20 €</b>
x 1	<b>16,00 €</b>
x 4	<b>20,50 €</b>



## Boîte fraîcheur Multipack



En APET. Couvercle rentrant avec charnière. De -40° C à +70° C.

<b>44652</b>	12,5 cl - L. 10,3 x l. 8,7 x H. 3,4 cm - Sachet de 100
<b>44653P</b>	25 cl - L. 12,6 x l. 10,6 x H. 4,1 cm - Sachet de 100
<b>44654P</b>	37,5 cl - L. 13,9 x l. 11,6 x H. 4,6 cm - Sachet de 50
<b>44656P</b>	75 cl - L. 17,4 x l. 14,6 x H. 5,9 cm - Sachet de 50
<b>44657P</b>	100 cl - L. 19,6 x l. 15,8 x H. 6,2 cm - Sachet de 40
<b>44658</b>	150 cl - L. 21,9 x l. 17,9 x H. 6,8 cm - Sachet de 75
<b>44659</b>	200 cl - L. 24 x l. 19,5 x H. 7,2 cm - Sachet de 50

	P.U.HT
x 8	<b>8,10 €</b>
x 1	<b>10,20 €</b>
x 1	<b>7,40 €</b>
x 1	<b>12,10 €</b>
x 1	<b>12,40 €</b>
x 2	<b>41,25 €</b>
x 4	<b>30,25 €</b>



## Boîte fraîcheur

Contenant de forme rectangulaire pour produits frais en RPET.

### Paquet de 50

<b>1011363P</b>	E 25 cl - L. 11,72 x l. 11,25 x H. 4,1 cm
<b>1011364P</b>	E 37,5 cl - L. 13,4 x l. 12,85 x H. 4,85 cm
<b>1011365P</b>	E 50 cl - L. 13,4 x l. 12,85 x H. 6,45 cm
<b>1011366P</b>	E 75 cl - L. 17,5 x l. 16,62 x H. 5,1 cm
<b>1011367P</b>	E 100 cl - L. 17,5 x l. 16,62 x H. 6,63 cm
<b>1011368P</b>	E 150 cl - L. 19,2 x l. 18,45 x H. 8 cm

	P.U.HT
x 1	<b>3,70 €</b>
x 1	<b>5,50 €</b>
x 1	<b>5,90 €</b>
x 1	<b>8,50 €</b>
x 1	<b>10,10 €</b>
x 1	<b>14,50 €</b>





## Wokipack



Fond noir, couvercle transparent en OPS, avec un évent excentré permettant l'évacuation de la vapeur d'eau: pas de buée. Barquette étanche pour sécuriser les déplacements. Résiste de -20° C à +130° C.

<b>Cocotte - Paquet de 15</b>			<b>P.U.HT</b>
<b>1007066P</b> 230 cl - L. 24,3 x l. 20,4 x H. 11 cm		x 18	<b>6,50 €</b>
<b>Couvercle - Paquet de 15</b>			
<b>1006318</b> L. 24 x l. 20 x H. 2,4 cm		x 18	<b>3,30 €</b>

nouveau !



<b>Boîte avec couvercle - Paquet de 15</b>			<b>P.U.HT</b>
<b>1013465P</b> L. 22,9 x l. 19,2 x H. 4,6 cm		x 12	<b>5,30 €</b>
<b>1013466P</b> L. 24,3 x l. 20,4 x H. 4,9 cm		x 12	<b>5,70 €</b>

## Marmipack



Hermétique. Livrée avec couvercle. Résiste à des températures de -10°C à +80°C.



<b>Boîte 1 compartiment - Sachet de 25</b>			<b>P.U.HT</b>
<b>A 65585P</b> 50 cl - L. 21,8 x l. 14 x H. 5,8 cm		x 8	<b>9,30 €</b>
<b>Boîte 2 compartiments - Sachet de 25</b>			<b>P.U.HT</b>
<b>B 65586P</b> 90 cl - L. 25,4 x l. 18,7 x H. 6,8 cm		x 8	<b>18,00 €</b>

## Prestipack



Résiste à des températures de -20°C à +130°C. Pratique : graduation sur un côté.



<b>Sachet de 30</b>			<b>P.U.HT</b>
<b>65581P</b> 60 cl - L. 15,8 x l. 13 x H. 5,5 cm		x 1	<b>8,90 €</b>
<b>65582P</b> 90 cl - L. 15,8 x l. 13 x H. 9,5 cm		x 1	<b>10,10 €</b>
<b>66007P</b> 100 cl - L. 17,5 x l. 15,9 x H. 8,5 cm		x 1	<b>11,30 €</b>
<b>65583P</b> 150 cl - L. 17,5 x l. 15,9 x H. 11,7 cm		x 1	<b>12,20 €</b>
<b>65584P</b> 180 cl - L. 17,5 x l. 15,9 x H. 13,7 cm		x 1	<b>13,30 €</b>

## Ondipack



Du congélateur au micro-ondes : résiste de -20°C à + 130°C. Boîtes à couvercle charnière bombé. Fermeture facile, étanchéité parfaite, rangement aisé.

<b>Sachet de 50</b>			<b>P.U.HT</b>
<b>57086P</b> E 25 cl - L. 12,3 x l. 11,4 x H. 5 cm		x 1	<b>5,00 €</b>
<b>66206P</b> 37,5 cl - L. 12,3 x l. 11,4 x H. 7,1 cm		x 1	<b>6,00 €</b>
<b>57087P</b> 50 cl - L. 14,2 x l. 12,3 x H. 6,9 cm		x 1	<b>7,90 €</b>
<b>1000765</b> 75 cl - L. 14,2 x l. 12,3 x H. 10,5 cm		x 12	<b>9,80 €</b>
<b>57088P</b> 80 cl - L. 18,5 x l. 13,5 x H. 6,8 cm		x 1	<b>11,00 €</b>
<b>1000763</b> 76 cl - L. 19 x l. 18,5 x H. 4,8 cm		x 6	<b>15,25 €</b>
<b>65580P</b> 120 cl - L. 19 x l. 18,5 x H. 6,8 cm		x 1	<b>17,50 €</b>
<b>57089P</b> 150 cl - L. 19 x l. 18,5 x H. 8,4 cm		x 1	<b>19,75 €</b>

nouveau !



## Cookipack



Résiste de -20° C à +120° C.

<b>Boîte - Paquet de 40</b>			<b>P.U.HT</b>
<b>1013514</b> 80 cl - L. 21,5 x l. 17 x H. 4 cm		x 8	<b>5,30 €</b>
<b>Couvercle - Paquet de 20</b>			<b>P.U.HT</b>
<b>1013515</b> L. 21,5 x l. 17 x H. 2 cm		x 16	<b>2,40 €</b>

## Boîte micro-ondes



Résiste à 100° C.



<b>Pot rond - Paquet de 50</b>			<b>P.U.HT</b>
<b>A 1013705P</b> 37,5 cl - Ø 13,3 x H 5,3 cm		x 1	<b>6,70 €</b>
<b>A 1013706P</b> 50 cl - Ø 13,3 x H 6,6 cm		x 1	<b>7,00 €</b>
<b>Couvercle pour pot - Paquet de 50</b>			
<b>B 1013707P</b> Ø 13,3 x H 1,5 cm		x 1	<b>5,50 €</b>
<b>Boîte carrée - Paquet de 50</b>			
<b>C 1013708P</b> 75 cl - L. 16,5 x l. 16,5 x H. 5,5 cm		x 1	<b>11,20 €</b>
<b>Couvercle carré - Paquet de 50</b>			
<b>D 1013709P</b> L. 16,9 x l. 16,9 x H. 2,3 cm		x 1	<b>8,20 €</b>
<b>Boîte rectangle - Paquet de 75</b>			
<b>E 1013710P</b> 60 cl - L. 23 x l. 16,8 x H. 3,6 cm		x 1	<b>19,75 €</b>
<b>Boîte rectangle 2 compartiments - Paquet de 75</b>			
<b>F 1013711P</b> 30 + 60 cl - L. 23 x l. 16,8 x H. 4,8 cm		x 1	<b>20,50 €</b>
<b>Couvercle rectangle</b>			
<b>G 1013712P</b> L. 23 x l. 17 x H. 2,1 cm		x 1	<b>13,30 €</b>





A



D



F



E



G

H

nouveau !

## Fibre moulée

En pulpe de canne à sucre. 100% OK Compost, biodégradable au sens de la norme européenne (EN 13432).

	<b>Barquette inclinée - Paquet de 50</b>				<b>P.U.HT</b>
<b>A 1013701P</b>	L. 18,4 x l. 18,6 x H. 7,7 cm		x1		<b>11,10 €</b>
	<b>Couvercle - Paquet de 50</b>				
<b>B 1013702P</b>	L. 19,2 x l. 19,2 x H. 3,8 cm		x1		<b>12,20 €</b>
	<b>Barquette carrée - Paquet de 50</b>				
<b>C 1013699P</b>	L. 17 x l. 17 x H. 5,3 cm		x1		<b>11,10 €</b>
<b>C 1013698P</b>	L. 17 x l. 17 x H. 3,7 cm		x1		<b>9,10 €</b>
	<b>Couvercle carré - Paquet de 50</b>				
<b>D 1013700P</b>	L. 17,5 x l. 17,5 x H. 1,7 cm		x1		<b>11,60 €</b>
	<b>Ravier rectangle - Paquet de 50</b>				
<b>E 1013693P</b>	L. 20 x l. 14 x H. 1 cm		x1		<b>9,00 €</b>
	<b>Couvercle rectangle - Paquet de 50</b>				
<b>F 1013694P</b>	L. 21 x l. 16 x H. 3 cm		x1		<b>12,50 €</b>
	<b>Barquette rectangle - Paquet de 75</b>				
<b>G 1013696P</b>	L. 23 x l. 16 x H. 5 cm		x1		<b>14,90 €</b>
<b>G 1013695P</b>	L. 23 x l. 16 x H. 3 cm		x1		<b>12,20 €</b>
	<b>Couvercle rectangle - Paquet de 75</b>				
<b>H 1013697P</b>	23,2x17,2x2,2 cm		x1		<b>17,75 €</b>

## 1<sup>er</sup> PRIX



## Barquette

Contenant pour produits chauds. Contact du produit avec les aliments 60 mn à 70° C et 30 mn à 100° C.

	<b>Barquette</b>				<b>P.U.HT</b>
<b>1011355P</b>	E 25,5 cl - L. 10,8 x l. 8,2 x H. 4,9 cm - Sachet de 50		x1		<b>2,20 €</b>
<b>1011356P</b>	E 30,5 cl - L. 10,8 x l. 8,2 x H. 6 cm - Sachet de 50		x1		<b>2,50 €</b>
<b>1011357P</b>	E 51 cl - L. 10,8 x l. 8,2 x H. 9,9 cm - Sachet de 50		x1		<b>3,40 €</b>
<b>1011359P</b>	E 83,1 cl - L. 18 x l. 13,5 x H. 5,55 cm - Sachet de 25		x1		<b>3,80 €</b>
<b>1011360P</b>	E 98 cl - L. 18 x l. 13,5 x H. 6,3 cm - Sachet de 25		x1		<b>4,10 €</b>
<b>1011361P</b>	E 151 cl - L. 18 x l. 13,45 x H. 8,6 cm - Sachet de 25		x1		<b>6,30 €</b>
	<b>Couvercle - Sachet de 50</b>				<b>P.U.HT</b>
<b>1011358P</b>	E Pour Boîte 25,5 cl - 30,5 cl - 51 cl		x1		<b>1,50 €</b>
<b>1011362P</b>	E Pour boîte 83,1 cl - 98 cl - 151 cl		x1		<b>5,50 €</b>

## nouveau !



## Barquette micro-ondes

Barquette alimentaire opaque, avec couvercle. Résiste de -20° C à +120° C.

	<b>Paquet de 200</b>				<b>P.U.HT</b>
<b>1013609P</b>	45 cl - L. 12,1 x l. 10,6 x H. 5,4 cm		x1		<b>52,50 €</b>
<b>1013610P</b>	75 cl - L. 14,2 x l. 11,8 x H. 6,8 cm		x1		<b>66,50 €</b>
	<b>Paquet de 100</b>				<b>P.U.HT</b>
<b>1013612P</b>	110 cl - L. 18,5 x l. 14,3 x H. 5,4 cm		x1		<b>44,25 €</b>
<b>1013611P</b>	115 cl - L. 15,9 x l. 13 x H. 8,3 cm		x1		<b>53,50 €</b>
<b>1013613P</b>	135 cl - L. 17 x l. 13,2 x H. 8,4 cm		x1		<b>48,25 €</b>
<b>1013614P</b>	180 cl - L. 18,5 x l. 14,3 x H. 9 cm		x1		<b>52,50 €</b>



## Barquette

Boîte avec couvercle. Résistant de -30° à + 70 °C.

	<b>Sachet de 50</b>				<b>P.U.HT</b>
<b>1012073</b>	29 cl - L. 13,8 x l. 10,4 x H. 3,8 cm		x10		<b>5,10 €</b>
<b>1012074</b>	43 cl - L. 13,8 x l. 10,4 x H. 5,3 cm		x10		<b>5,70 €</b>
<b>1012078</b>	57 cl - L. 13,8 x l. 10,4 x H. 6,8 cm		x10		<b>6,40 €</b>
<b>1012081</b>	65 cl - L. 15,9 x l. 12 x H. 4,7 cm		x6		<b>8,10 €</b>
<b>1012082</b>	84 cl - L. 18,3 x l. 13,9 x H. 5,3 cm		x4		<b>9,20 €</b>
<b>1012083</b>	112 cl - L. 18,3 x l. 13,9 x H. 6,7 cm		x4		<b>9,90 €</b>
<b>1012084</b>	173 cl - L. 18,3 x l. 13,9 x H. 10,2 cm		x4		<b>12,20 €</b>



## Boîte snacking

En carton. Imperméable et micro-onidable.

	<b>Sachet de 50</b>				<b>P.U.HT</b>
<b>1001437P</b>	50 cl - L. 14 x l. 10,5 x H. 5,5 cm		x1		<b>31,75 €</b>
<b>1001436P</b>	100 cl - L. 19 x l. 14 x H. 5 cm		x1		<b>35,50 €</b>



## Taste

Boîte repas en carton micro-cannelé à couvercle avec fenêtre couche interne en PE qui assure l'étanchéité des produits aux sauces. Passe au micro-ondes et au four à 220° pendant 30 min.

	<b>Sachet de 250</b>				<b>P.U.HT</b>
<b>1011533P</b>	50 cl - L. 12,5 x l. 8 x H. 6 cm - Sachet de 250		x1		<b>94,00 €</b>
<b>1011534P</b>	75 cl - L. 12,5 x l. 12,5 x H. 6 cm - Sachet de 140		x1		<b>71,00 €</b>
<b>1011535P</b>	120 cl - L. 18,5 x l. 12,5 x H. 6 cm - Sachet de 110		x1		<b>69,00 €</b>





# Moule de cuisson aluminium\*

Jusqu'à 200° C.



Barquette operculable - Paquet de 100

- 1010204** E 43,5 cl - L. 14,6 x l. 12,1 x H. 4 cm
- 1010205P** E 68,5 cl - L. 20,1 x l. 10,9 x H. 4,9 cm
- 1010206** 91 cl - L. 21,8 x l. 15,5 x H. 3,8 cm

- P.U.HT**  
x 10 **8,70 €**
- x 1 **14,30 €**
- x 4 **18,50 €**



Couvercle operculable - Paquet de 100

- 1010227** E Pour barquette 68,5 cl
- 1010228** Pour barquette 91 cl

- P.U.HT**  
x 5 **4,30 €**
- x 4 **6,70 €**



Barquette - Paquet de 200

- 1010198P** 49 cl - L. 15 x l. 12,4 x H. 4,4 cm
- 1010199P** 82 cl - L. 20,1 x l. 13,7 x H. 4,5 cm
- 1010200** 89 cl - L. 20,3 x l. 13,8 x H. 5 cm

- P.U.HT**  
x 1 **10,10 €**
- x 1 **16,50 €**
- x 7 **17,00 €**



Plat cuivre

- 1010218** 315 cl - L. 36,8 x l. 24,7 x H. 4,8 cm
- 1010217** 400 cl - L. 36,8 x l. 24,9 x H. 5,9 cm

- P.U.HT**  
x 100 **150,00 €**
- x 100 **210,00 €**



Plat GN 1/2

- 1010219** 360 cl - L. 32,2 x l. 26,2 x H. 6 cm - Paquet de 100
- 1010220** 425 cl - L. 32,5 x l. 26,5 x H. 6,5 cm - Paquet de 172

- P.U.HT**  
x 10 **56,50 €**
- x 1 **184,00 €**



Plat rectangulaire - Paquet de 100

- 1011141** 61 cl - L. 20,6 x l. 13,8 x H. 2,8 cm
- 1011136** 262,5 cl - GN 1/2 L. 32,2 x l. 26,2 x H. 3,8 cm

- P.U.HT**  
x 12 **240,00 €**
- x 1 **38,75 €**



Coquille - Paquet de 100

- 1010207** 13,5 cl - Ø 12,3 x H. 2 cm

- P.U.HT**  
x 10 **7,10 €**



Moule à cake

- 1010212P** 105 cl - L. 23,2 x l. 10,8 x H. 6 cm - Paquet de 100
- 1010213P** 164 cl - L. 24,7 x l. 13,3 x H. 6,8 cm - Paquet de 50

- P.U.HT**  
x 1 **19,50 €**
- x 1 **19,50 €**



Tourtière - Paquet de 100

- 1010211P** 16 cl - Ø 10,9 x H. 2,1 cm
- 1010210** 22 cl - Ø 13,8 x H. 2 cm

- P.U.HT**  
x 1 **5,70 €**
- x 15 **7,70 €**



Ramequin - Paquet de 100

- 1010215P** E 17,6 cl - Rond Ø 9,3 x H. 3,6 cm
- 1010214P** 25,1 cl - Rond Ø 10,7 x H. 4,1 cm

- P.U.HT**  
x 1 **17,50 €**
- x 1 **18,50 €**



Godet - Paquet de 100

- 1010221P** E 9 cl - Ø 7,5 x H. 3,4 cm
- 1010222P** E 11 cl - Ø 8 x H. 3,5 cm
- 1010223P** E 15 cl - Ø 8,5 x H. 4,1 cm

- P.U.HT**  
x 1 **5,10 €**
- x 1 **5,30 €**
- x 1 **6,00 €**

\* À utiliser seulement dans les fours qui permettent l'utilisation de celui-ci. Le conteneur ne doit pas toucher les parois du four, 2 cm minimum entre les parois du four et la barquette. Ne pas mettre le conteneur vide dans le four.



nouveau !

## Barquette en bois

Barquette salade avec couvercle plastique transparent.

**solia**



Paquet de 50

<b>1013633</b>	70 cl - L. 18,5 x l. 13,5 x H. 4 cm
<b>1013632</b>	100 cl - L. 25 x l. 13 x H. 4 cm

	<b>P.U.HT</b>
x 4	<b>43,50 €</b>
x 3	<b>59,50 €</b>

## Saladier en bois

Couvercle en OPS.

**solia**



Saladier - Paquet de 20

<b>1013630</b>	65cl - Ø 15,5 cm x H. 4,5 cm
----------------	------------------------------

	<b>P.U.HT</b>
x 10	<b>16,75 €</b>

Couvercle - Paquet de 100

<b>1013631</b>	Ø 16,3 x H. 2,5 cm
----------------	--------------------

	<b>P.U.HT</b>
x 2	<b>23,75 €</b>

## Moule de cuisson bois

Papier de cuisson siliconé double face inclus.  
De -40° à +240° C.



Possibilité de personnaliser vos moules et barquettes. Consultez-nous !



Moule rectangle

			<b>P.U.HT</b>
<b>1006325</b>	L. 12 x l. 9,5 x H. 3,5 cm - Paquet de 400	x 1	<b>166,00 €</b>
<b>1006326</b>	L. 14 x l. 9,5 x H. 5 cm - Paquet de 240	x 1	<b>104,00 €</b>
<b>1006323</b>	L. 17,5 x l. 7,5 x H. 5 cm - Paquet de 175	x 1	<b>88,00 €</b>
<b>1006324</b>	L. 17,5 x l. 11 x H. 5 cm - Paquet de 100	x 1	<b>52,00 €</b>
<b>1006319</b>	L. 24 x l. 11,5 x H. 7 cm - Paquet de 100	x 1	<b>67,50 €</b>
<b>1006320</b>	L. 29 x l. 8 x H. 4,5 cm - Paquet de 100	x 1	<b>67,50 €</b>



Moule octo

<b>1006322</b>	Ø 14,5 x H. 4,5 cm - Paquet de 210
<b>1006321</b>	Ø 18 cm x H. 5 cm - Paquet de 120

	<b>P.U.HT</b>
x 1	<b>112,00 €</b>
x 1	<b>77,50 €</b>

## Caissette

Caissette servant à la cuisson et la présentation.



Paquet de 100

<b>1008400P</b>	Ø 3,8 x H. 2,8 cm - Blanc
-----------------	---------------------------

	<b>P.U.HT</b>
x 30	<b>5,00 €</b>

Paquet de 250

<b>1000608P</b>	Ø 5,4 x H. 4 cm - Marron
<b>1000609P</b>	Ø 5,4 x H. 4 cm - Blanc

	<b>P.U.HT</b>
x 10	<b>20,50 €</b>
x 16	<b>17,50 €</b>



## Salades



Gamme Tusipack

Gamme Takipack

Gamme Crudipack

## Plats chauds



Gamme Cookipack

Gamme Wokipack

Gamme Prestipack

Gamme Marmipack

## Desserts



Gamme Servipack Dessert

Gamme Takipack Dessert

Gamme Moulipack Dessert

# Alphaform

Alphaform est le partenaire emballages et vaisselle à usage unique des commerces traditionnels et de la consommation hors domicile, sociale et commerciale.

Avec leurs designs épurés et leurs praticités, nos gammes permettent de répondre au mieux à la demande des utilisateurs finaux tels que les « métiers de bouche », les « collectivités » ou la « VAESnacking ».



nouveau !



GN 1/2  
GN 1/3

CL 750  
GN 1/4



CL 250  
GN 1/8

## Scelleuse manuelle

TECHNITRANS  
Constructeur de machines d'emballage

GARANTIE 1 an CE

Machine permettant de sceller hermétiquement des barquettes aluminium, plastiques, carton, bois, avec des films adaptés. Découpe et soude simultanément du film. Régulation électronique de la température. Fabrication inox alimentaire. Outillages de scellage non inclus adaptés notamment au format maximum GN 1/2 (325 x 265 mm). Système de relevage des barquettes. Anti-rolling pour film pelable. Relevage du bras de soudure par vérin gaz. Réglage de température extérieure de 90° à 180° par potentiomètre. Utilisation en restauration collective. Alimentation 230 V. Puissance 1000 W.

### Scelleuse 1/2 gastronomique manuelle

1013424

L. 43 x l. 65 x H. 60 cm  
Poids 25 kg

x 1

P.U.HT  
3 345,00 €



## Scelleuse manuelle

GARANTIE 1 an CE

En inox. Découpe et soude du film simultanément. Idéal pour la restauration à emporter et les collectivités pour tous types de barquettes thermoscellables (9,5 x 13,5 cm et 13,5 x 19,5 cm) en PP, PS, PET et PVC. Pour tous les formats de 250 à 2000 cl grâce à la matrice réglable. Alimentation 230 V. Puissance 400 W.

### OP140

62439

L. 54,5 x l. 19 x H. 44 cm  
Poids 8 kg.

x 1

P.U.HT  
823,00 €



### Film pelable pour scelleuse

69336P

L. 300 m x l. 15 cm

x 1

P.U.HT  
33,25 €

Le film pelable est composé d'un film PET 12µ + PE 50µ. Une fois le scellage réalisé, il permet de décoller ce dernier manuellement avant consommation.



### Film soudable pour scelleuse

45113

L. 500 m x l. 15 cm

x 1

P.U.HT  
20,25 €

Le film soudable est composé d'un matériau PP (identique aux barquettes). Le scellage est réalisé par fusion des deux matériaux. À ouvrir avec une lame.



## Barquette scellable Alphacel

ALPHA

micro-ondes

PS  
POLYPROPYLENE

En polypropylène. Barquette micro-ondable. Idéale pour l'hygiène de vos préparations. Plage de scellage standard. Résiste à des températures de -20°C à +130°C.

### 25 cl - Sachet de 100

65465P

L. 13,7 x l. 9,6 x H. 3,2 cm

x 1

P.U.HT  
3,60 €

### 37 cl - Sachet de 120

65457P

L. 13,7 x l. 9,6 x H. 4,9 cm

x 1

P.U.HT  
4,60 €

### 50 cl - Sachet de 100

65456P

L. 13,7 x l. 9,6 x H. 6,6 cm

x 1

P.U.HT  
5,20 €

### 73 cl - Sachet de 140

65458P

L. 19,2 x l. 13,7 x H. 4,1 cm

x 1

P.U.HT  
10,30 €

### 100 cl - Sachet de 160

65459P

L. 19,2 x l. 13,7 x H. 5,5 cm

x 1

P.U.HT  
14,20 €

### 150 cl - Sachet de 110

66205P

L. 19,2 x l. 13,7 x H. 8,6 cm

x 1

P.U.HT  
10,80 €



nouveau !



## Sac cabas

Impression primeur.



Paquet de 100  
**1013607** L. 40 x l. 35 cm - Soufflet de 20 cm

**P.U.HT**  
x 1 **121,00 €**

## Sac isotherme

Isotherme, avec fermeture velcro.



Paquet de 100  
**1013608** L. 38 x 44 cm - Soufflet de 19 cm

**P.U.HT**  
x 1 **342,00 €**



## Sac cabas

Sac cabas avec fond plat et poignées plates. 80 g/m<sup>2</sup>. Possibilité de personnaliser. Nous consulter.



**Kraft Blanc - Carton de 250**  
**1002259P** L. 26 x l. 26 cm - Soufflet de 20 cm

**P.U.HT**  
x 1 **52,50 €**

**Kraft Brun - Carton de 250**  
**1009337** L. 18 x l. 22 cm - Soufflet de 8 cm  
**1002260P** L. 20 x l. 26 cm - Soufflet de 26 cm  
**1009338** L. 22 x l. 29 cm - Soufflet de 10 cm  
**1009340** L. 26 x l. 27 cm - Soufflet de 17 cm  
**1009339** L. 26 x l. 29 cm - Soufflet de 14 cm  
**1009341** L. 32 x l. 38 cm - Soufflet de 17 cm  
**1009343** L. 32 x l. 44 cm - Soufflet de 17 cm

**P.U.HT**  
x 1 **36,00 €**  
x 1 **53,00 €**  
x 1 **40,75 €**  
x 1 **48,50 €**  
x 1 **50,50 €**  
x 1 **64,50 €**  
x 1 **67,00 €**

**Carton de 100**  
**1009342** L. 45 x l. 47 cm - Soufflet de 17 cm

x 1 **48,50 €**



## Sac fast food

60 g/m<sup>2</sup>. Idéal pour fruits et légumes, snacking fast food...



**Kraft Brun**  
**1009344** L. 14 x l. 22 cm - Soufflet de 9 cm - Paquet de 1300  
**1003330P** L. 18 x l. 34 cm - Soufflet de 11 cm - Paquet de 500  
**1009599** L. 27 x l. 40 cm - Soufflet de 15 cm - Paquet de 50

**P.U.HT**  
x 1 **51,00 €**  
x 1 **36,50 €**  
x 5 **8,00 €**



## Sac bouteille

En papier kraft brun. Parfait pour proposer une solution doggy bag aux restaurateurs.

**Carton de 250**  
**1009024P** L. 14 x L. 36 cm - Soufflet de 8 cm

**P.U.HT**  
x 1 **80,50 €**

## Sac multi-usages

Transparents, pour viennoiseries, confiseries... 50 µ.



**Paquet de 200**  
**1013375** L. 17 x l. 22 cm  
**1013376** L. 23 x l. 31 cm  
**1013377** L. 30 x l. 35 cm

**P.U.HT**  
x 15 **5,40 €**  
x 10 **9,50 €**  
x 5 **13,90 €**

## Sac bretelle

Pratique, multi-usages, réutilisable. 50 µ.



**Blanc**  
**1009348** L. 21 x l. 40 cm - Sachet de 1000  
**1009349** L. 26 x l. 45 cm - Sachet de 500  
**1009353** L. 30 x l. 54 cm - Sachet de 500  
**1009359** L. 45 x l. 45 cm - Sachet de 250

**P.U.HT**  
x 1 **68,00 €**  
x 1 **40,25 €**  
x 1 **57,00 €**  
x 1 **59,50 €**

**Bleu**  
**1009350** L. 26 x l. 45 cm - Sachet de 500  
**1009354** L. 30 x l. 54 cm - Sachet de 500

**P.U.HT**  
x 1 **39,25 €**  
x 1 **57,00 €**

**Vert**  
**1009351** L. 26 x l. 45 cm - Sachet de 500  
**1009355** L. 30 x l. 54 cm - Sachet de 500

**P.U.HT**  
x 1 **39,25 €**  
x 1 **57,00 €**

**Rose**  
**1009352** L. 26 x l. 45 cm - Sachet de 500  
**1009356** L. 30 x l. 54 cm - Sachet de 500

**P.U.HT**  
x 1 **39,25 €**  
x 1 **57,00 €**



SACS



USAGE UNIQUE



## Bloc commandes



Papier autocopiant, numéroté de 1 à 50.  
Encart détachable.

	Tripli				<b>P.U.HT</b>
✓	<b>52700P</b>	L. 15 x l. 8 cm	x 50		<b>1,50 €</b>
✓	<b>1002402P</b>	L. 17 x l. 9,5 cm	x 10		<b>1,70 €</b>

	Dupli				<b>P.U.HT</b>
✓	<b>52699P</b>	L. 15 x l. 8 cm	x 50		<b>1,10 €</b>
✓	<b>1002401P</b>	L. 17 x l. 9,5 cm	x 10		<b>1,40 €</b>



## Bloc brasserie

Pour la prise de commande au restaurant,  
6 coupons, papier autocopiant, avec encart  
détachable. 50 liasses encollées en pied. Zone  
neutralisée en pied afin d'éviter de perdre des  
informations lors de la prise des commandes.

	Tripli - Paquet de 10				<b>P.U.HT</b>
✓	<b>69441P</b>	L. 25,9 x l. 10 cm	x 1		<b>27,75 €</b>

	Dupli - Paquet de 10				<b>P.U.HT</b>
✓	<b>69440P</b>	L. 25,9 x l. 10 cm	x 1		<b>21,00 €</b>



## Bloc addition

Carnet pour rédiger les additions au restaurant  
en papier autocopiant, numéroté de 1 à 50.  
Avec intercalaire protège-écriture détachable.  
Double taux pour les TVA normale et réduite.  
Large zone pour apposer le tampon de  
l'établissement.

✓	Dupli - Paquet de 10				<b>P.U.HT</b>
	<b>69437P</b>	L. 23,5 x l. 10,2 cm	x 1		<b>16,50 €</b>



## Socle porte-fiches

En inox et marbre.

✓	<b>31445P</b>	H. 16 cm	x 1		<b>P.U.HT</b> <b>15,50 €</b>
---	---------------	----------	-----	--	---------------------------------



## Barre à fiches aluminium



					<b>P.U.HT</b>
	<b>67625P</b>	Longueur 60 cm	x 2		<b>24,75 €</b>
	<b>67626P</b>	Longueur 92 cm	x 2		<b>30,75 €</b>

## Barre porte-fiches

En inox. H 9,5 cm.



					<b>P.U.HT</b>
✓	<b>44759P</b>	8 clips - L. 62,5 cm	x 1		<b>27,50 €</b>
✓	<b>44760P</b>	12 clips - L. 100 cm	x 1		<b>39,50 €</b>

## Bobine carte bancaire

En papier thermique. Epaisseur 55g/m<sup>2</sup>.  
Mandrin 12 mm. Ø 4 cm.



	Paquet de 50				<b>P.U.HT</b>
✓	<b>1002393P</b>	L. 18 m x l. 5,7 cm	x 1		<b>28,75 €</b>

## Bobine papier autocopiant pour caisse

En papier chimique autocopiant.  
Epaisseur 55g/m<sup>2</sup>.  
Mandrin 12 mm Ø ext. 7,6 cm.



	Paquet de 50				<b>P.U.HT</b>
✓	<b>1002398P</b>	L. 22 m x l. 7 cm	x 1		<b>63,50 €</b>

## Bobine papier offset pour caisse

En papier offset 60 g/m<sup>2</sup>.  
Mandrin 12 mm Ø ext. 7,6 cm.



	Paquet de 50				<b>P.U.HT</b>
✓	<b>1002396P</b>	L. 44 m x l. 7 cm	x 1		<b>56,00 €</b>

## Bobine papier thermique sans BPA pour caisse

En papier thermique 55 g/m<sup>2</sup> sans bisphénol A.  
Mandrin 12 mm. Ø ext. 8 cm.



	Paquet de 30				<b>P.U.HT</b>
✓	<b>1002397P</b>	L. 75 m x l. 8 cm	x 1		<b>79,00 €</b>

## Bobine papier thermique pour caisse

En papier thermique 55 g/m<sup>2</sup>.  
Mandrin 12 mm Ø ext. 8 cm.



	Paquet de 30				<b>P.U.HT</b>
✓	<b>1002394P</b>	L. 75 m x l. 8 cm	x 1		<b>57,50 €</b>

En papier thermique 48 g/m<sup>2</sup>.  
Mandrin 12 mm Ø ext. 8 cm.

	Paquet de 50				<b>P.U.HT</b>
✓	<b>69406P</b>	L. 50 m x l. 6 cm	x 1		<b>85,00 €</b>





## Collection Damas 67 par Déglon

### Exception, performance et tradition

Des couteaux offrant qualité de coupe, esthétisme et confort d'utilisation :

- Lame composée en son coeur du fameux acier VG10, hautement chargé en carbone, apportant dureté et longévité de coupe. De part et d'autre, 66 couches damassées de 2 aciers 420 et 431 assurant inoxydabilité et esthétique d'exception.
- Manche réalisé en matériau de type « Corian » : excellente résistance aux chocs, aux taches, aux UV et aux bactéries.

Gamme composée de 6 couteaux : Offices 9 et 11 cm, Santoku 18 cm, Découper 23 cm, Chefs 20 et 25 cm.



# CUISINE

STOCKAGE ET MANUTENTION .....332

MATÉRIEL ÉLECTRIQUE .....358

MATÉRIEL DE CUISSON .....382

MATÉRIEL DE PRÉPARATION .....410



# Camshelving



Le rayonnage Camshelving est proposé en 5 hauteurs (140 à 180 cm), 4 profondeurs (30 à 60 cm) et 12 longueurs (60 à 170 cm) afin de vous permettre d'élaborer une configuration efficace dans tous les espaces.

CONSULTER VOTRE MAGASIN ECOTEL



Scannez pour découvrir la gamme Camshelving

Raccords d'angle connectent facilement une unité de base et une unité additionnelle.

**54075** x 1 **P.U.HT 2,80 €**

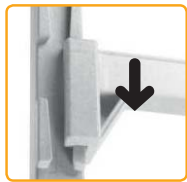

Les traverses s'enclenchent facilement sur les queues d'arondes.



Montants et traverses constitués d'une âme d'acier garantissant la solidité et la stabilité des rayonnages.



Pour utilisation en milieu humide ou sec.

Supporte jusqu'à -38 °C : idéal en chambre froide.

Traverses et montants constitués d'une âme d'acier enrobée de polypropylène lisse : très grande robustesse et durabilité.

Sans soudure et inoxydable : hygiénique, garanti à vie contre la rouille et la corrosion.

Éléments lavables au lave-vaisselle : entretien facile.

Très simple à monter, sans outils, par simple enclenchement des différents éléments.

Charge maximale par étagère : 200 kg.

Attention : ces rayonnages sont sur commande spéciale : ni repris, ni échangés.



Rayonnage additionnel et rayonnage de base se connectent en ligne droite en partageant une paire de montants central.

- Maximise coût et espace
- Pas de perte de charge

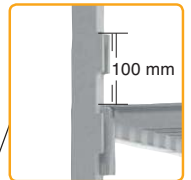

Les étagères s'ajustent par intervalles de 10 cm sans démonter l'unité.



À l'épreuve de l'humidité, du sel et des produits chimiques.



Conception hygiénique. Tablettes intègrent une protection anti-microbienne Camguard® qui exerce une action permanente contre la prolifération des microbes entre les lavages.

Autres options : nous consulter.



Rack de séchage



Rack de séchage plateaux



Système d'identification du rayonnage

Caillebotis Voir page 357

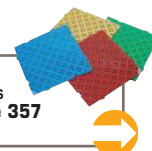

## Rayonnage 2 kits de montants et 4 kits d'étagères

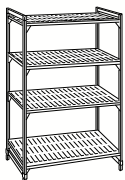

				P.U.HT	Dont Éco-participation
<b>65785</b>	L. 98 x l. 40 x H. 170 cm	x 1	<b>360,00 €</b>	<b>2,84 €</b>	
<b>65786</b>	L. 108 x l. 40 x H. 170 cm	x 1	<b>381,00 €</b>	<b>3,06 €</b>	
<b>65787</b>	L. 118 x l. 40 x H. 170 cm	x 1	<b>396,00 €</b>	<b>3,18 €</b>	
<b>65788</b>	L. 138 x l. 40 x H. 170 cm	x 1	<b>444,00 €</b>	<b>3,50 €</b>	
<b>65793</b>	L. 98 x l. 60 x H. 170 cm	x 1	<b>419,00 €</b>	<b>3,17 €</b>	
<b>65794</b>	L. 108 x l. 60 x H. 170 cm	x 1	<b>439,00 €</b>	<b>3,36 €</b>	
<b>65795</b>	L. 118 x l. 60 x H. 170 cm	x 1	<b>456,00 €</b>	<b>3,48 €</b>	
<b>65796</b>	L. 138 x l. 60 x H. 170 cm	x 1	<b>527,00 €</b>	<b>4,12 €</b>	



## Rayonnage mobile : 2 kits de montants + 4 kits d'étagères + 4 roues

				P.U.HT	Dont Éco-participation
<b>66158</b>	L. 138 x l. 60 x H. 179 cm	x 1	<b>733,00 €</b>	<b>4,66 €</b>	
<b>66157</b>	L. 118 x l. 60 x H. 179 cm	x 1	<b>669,00 €</b>	<b>3,58 €</b>	

## Rayonnage additionnel 1 kit de montants et 4 kits d'étagères

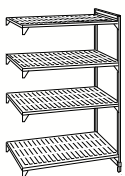

				P.U.HT	Dont Éco-participation
<b>65789</b>	L. 94 x l. 40 x H. 170 cm	x 1	<b>293,00 €</b>	<b>2,23 €</b>	
<b>65790</b>	L. 104 x l. 40 x H. 170 cm	x 1	<b>301,00 €</b>	<b>2,45 €</b>	
<b>65791</b>	L. 114 x l. 40 x H. 170 cm	x 1	<b>316,00 €</b>	<b>2,57 €</b>	
<b>65792</b>	L. 134 x l. 40 x H. 170 cm	x 1	<b>376,00 €</b>	<b>2,89 €</b>	
<b>65797</b>	L. 94 x l. 60 x H. 170 cm	x 1	<b>350,00 €</b>	<b>2,57 €</b>	
<b>65798</b>	L. 104 x l. 60 x H. 170 cm	x 1	<b>366,00 €</b>	<b>2,76 €</b>	
<b>65799</b>	L. 114 x l. 60 x H. 170 cm	x 1	<b>384,00 €</b>	<b>2,88 €</b>	
<b>66000</b>	L. 134 x l. 60 x H. 170 cm	x 1	<b>450,00 €</b>	<b>3,52 €</b>	



## Etagère pleine. Charge maximale 68 kg

				P.U.HT	Dont Éco-participation
<b>55161</b>	E L. 91 x l. 46 x H. 34 cm	x 1	<b>149,00 €</b>	<b>0,33 €</b>	



## Etagère claire-voie. Charge maximale 68 kg

				P.U.HT	Dont Éco-participation
<b>60720</b>	E L. 91 x l. 36 x H. 34 cm	x 1	<b>116,00 €</b>	<b>0,27 €</b>	

# Camshelving Basics Plus



Le nouveau système de rayonnage Cambro est adapté à toutes les zones de stockage (froid, chaud, sec, ...) de -38°C à +88°C.

Garanti à vie contre la corrosion et la rouille, il allie une résistance aux moisissures, aux produits chimiques et aux agents lessiviels avec une grande facilité de nettoyage. Montage aisé et grande résistance à la charge, jusqu'à 800 kg pour un élément !

Facile à monter (les montants sont livrés assemblés), sa configuration peut être modifiée sans désassembler l'ensemble du rayonnage (étagère par étagère).

Fabriqué à partir de composites : il est donc garanti à vie contre la rouille et la corrosion, et son entretien est simple : clayettes amovibles et lavables en lave-vaisselle industriel.

La résistance à la charge : 190 kg par étagère de moins d'1 mètre !



COMPONENTS

### Rayonnage 2 kits de montants et 4 kits d'étagères

Largeur 46 cm			P.U. HT	Dont Éco-participation
<b>1003388</b>	E L. 91 x l. 46 x H. 183 cm	x 1	<b>267,00 €</b>	<b>1,48 €</b>
<b>1003389</b>	E L. 107 x l. 46 x H. 183 cm	x 1	<b>294,00 €</b>	<b>1,60 €</b>
<b>1003390</b>	E L. 122 x l. 46 x H. 183 cm	x 1	<b>305,00 €</b>	<b>1,73 €</b>
<b>1003391</b>	E L. 138 x l. 46 x H. 183 cm	x 1	<b>333,00 €</b>	<b>1,86 €</b>
<b>1003392</b>	E L. 153 x l. 46 x H. 183 cm	x 1	<b>354,00 €</b>	<b>1,97 €</b>

Largeur 54 cm			P.U. HT	Dont Éco-participation
<b>1003393</b>	E L. 91 x l. 54 x H. 183 cm	x 1	<b>306,00 €</b>	<b>1,61 €</b>
<b>1003394</b>	E L. 107 x l. 54 x H. 183 cm	x 1	<b>323,00 €</b>	<b>1,75 €</b>
<b>1003395</b>	E L. 122 x l. 54 x H. 183 cm	x 1	<b>336,00 €</b>	<b>1,89 €</b>
<b>1003396</b>	E L. 138 x l. 54 x H. 183 cm	x 1	<b>368,00 €</b>	<b>2,03 €</b>
<b>1003397</b>	E L. 153 x l. 54 x H. 183 cm	x 1	<b>393,00 €</b>	<b>2,16 €</b>

Largeur 61 cm			P.U. HT	Dont Éco-participation
<b>1003398</b>	E L. 91 x l. 61 x H. 183 cm	x 1	<b>301,00 €</b>	<b>1,76 €</b>
<b>1003399</b>	E L. 107 x l. 61 x H. 183 cm	x 1	<b>330,00 €</b>	<b>1,92 €</b>
<b>1003400</b>	E L. 122 x l. 61 x H. 183 cm	x 1	<b>350,00 €</b>	<b>2,05 €</b>
<b>1003401</b>	E L. 138 x l. 61 x H. 183 cm	x 1	<b>377,00 €</b>	<b>2,21 €</b>
<b>1003402</b>	E L. 153 x l. 61 x H. 183 cm	x 1	<b>400,00 €</b>	<b>2,36 €</b>



**TOURNUS<sup>®</sup>**  
**EQUIPEMENT**

**Fier de mon  
équipement !**



## **Tout l'équipement pour votre cuisine**

Premier fabricant français d'équipement inox, Tournus Equipement a construit sa notoriété grâce à la qualité de ses produits, l'étendue de sa gamme : manutention (chariots, échelles), mobilier inox (plonges, tables, meubles), remise et maintien en température etc...

Les produits fabriqués à Tournus sont conçus avec la double exigence de robustesse et d'ergonomie, ils offrent la garantie de la fiabilité.



## Rayonnage

En polypropylène haute densité et Duralinox anodisé.  
Montage simple et rapide sans outil. S'adapte à vos besoins.  
Longerons en tube de 25 x 42 mm. Robuste.  
Résiste aux températures de -30°C à + 60°C.  
Supporte en charge jusqu'à 150 kg répartis par niveau,  
120 kg pour les longueurs 193,2 cm et 149,4 cm.

Idéal pour équiper vos chambres froides.  
Autres dimensions et unités additionnelles  
également disponibles : nous consulter.



**Une personne seule assemble 5 mètres en 5 minutes et sans aucun outil.**  
Retrouvez le film de montage en scannant le flashcode.

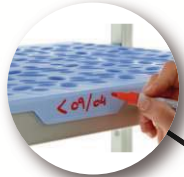

**Exclusivité Tournus :**  
Marquage direct à la main sur le bord de la clayette, avec un feutre à encre effaçable, aide à la gestion du stock de denrées alimentaires (2 feutres fournis).

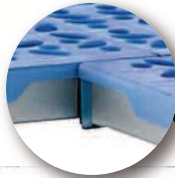

**Accessibilité maximale :**  
Le crochet d'angle permet de supprimer l'échelle et de stocker les produits y compris dans l'angle. Nettoyage des sols facilité.



**Hygiène :**  
Clayettes amovibles, lavables en machine jusqu'à 90° C.



**Robustesse :**  
Montants en tube aluminium anodisé 32 x 30 mm.



**Facilité de montage :**  
Par emboîtement conique autobloquant qui rigidifie la structure.



**Résistance à la charge :**  
150 kg répartis par niveau.

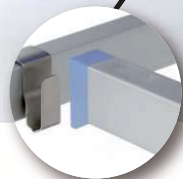

**Modularité :**  
Montage en ligne ou en angle.



**Stabilité :**  
Vérins réglables sans filetage apparent hygiène.



### Rayonnage de base, 4 niveaux de clayettes amovibles

#### Largeur 40 cm

				P.U. HT	Dont Eco-participation
65743	E L. 99,2 x l. 40 x H. 175 cm	x 1	367,00 €	0,25 €	
65744	E L. 119,2 x l. 40 x H. 175 cm	x 1	397,00 €	0,28 €	
65745	E L. 149,4 x l. 40 x H. 175 cm	x 1	448,00 €	0,33 €	

#### Largeur 50 cm

				P.U. HT	Dont Eco-participation
55175	E L. 99,2 x l. 50 x H. 175 cm	x 1	377,00 €	0,28 €	
65746	E L. 119,2 x l. 50 x H. 175 cm	x 1	405,00 €	0,32 €	



### Rayonnage additionnel, 4 niveaux de clayettes amovibles. (angle ou en ligne)

#### Largeur 40 cm

				P.U. HT	Dont Eco-participation
1007746	E L. 95,1 x l. 40 x H. 175 cm	x 1	310,00 €	0,23 €	
65747	E L. 115,1 x l. 40 x H. 175 cm	x 1	339,00 €	0,24 €	
1007747	E L. 155,3 x l. 40 x H. 175 cm	x 1	402,00 €	0,31 €	

#### Largeur 50 cm

				P.U. HT	Dont Eco-participation
1007749	E L. 95,1 x l. 50 x H. 175 cm	x 1	317,00 €	0,24 €	
65748	E L. 115,1 x l. 50 x H. 175 cm	x 1	345,00 €	0,27 €	
1007748	E L. 155,3 x l. 50 x H. 175 cm	x 1	414,00 €	0,35 €	





## Table inox standard

En acier inoxydable, hauteur 90 cm, réglable jusqu'à 93 cm. Plan de travail épaisseur 1,5 mm doublé par panneau stratifié double face. Bandeau avant et dossier rayonnés. Piètement en tube inox Ø 45 mm équipé de vérins avec embouts anti-dérappants. Montage très rapide, sans outils. Pieds arrières en retrait de 65 mm sur les tables à dossier et de 55 mm sur les tables centrales. Possibilité de montage instantané de tiroirs en toutes positions sur le cadre profilé à cet effet.



### Sans dossier. Avec étagère

			P.U.HT	Dont éco-participation
42409	L. 100 x l. 70 cm	x 1	659,00 €	0,61 €
42410	L. 120 x l. 70 cm	x 1	680,00 €	0,70 €
42411	L. 140 x l. 70 cm	x 1	764,00 €	0,79 €
42412	L. 160 x l. 70 cm	x 1	810,00 €	0,88 €
42413	L. 180 x l. 70 cm	x 1	860,00 €	1,01 €
42414	L. 200 x l. 70 cm	x 1	909,00 €	1,07 €
42415	L. 220 x l. 70 cm	x 1	1 055,00 €	1,31 €
42416	L. 240 x l. 70 cm	x 1	1 170,00 €	1,40 €

### A dossier. Avec étagère

			P.U.HT	Dont éco-participation
42419	L. 100 x l. 70 cm	x 1	705,00 €	0,61 €
42420	L. 120 x l. 70 cm	x 1	725,00 €	0,74 €
42421	L. 140 x l. 70 cm	x 1	773,00 €	0,79 €
42422	L. 160 x l. 70 cm	x 1	861,00 €	0,88 €
42423	L. 180 x l. 70 cm	x 1	939,00 €	1,01 €
42424	L. 200 x l. 70 cm	x 1	964,00 €	1,07 €
42425	L. 220 x l. 70 cm	x 1	1 096,00 €	1,31 €
42426	L. 240 x l. 70 cm	x 1	1 217,00 €	1,40 €



Nettoyage facilité grâce à l'absence totale d'interstices dans les angles.



Tables inox avec roues, nous consulter

## 1<sup>er</sup> PRIX

### Table inox CHR

En acier inoxydable, hauteur 90 cm, réglable jusqu'à 93 cm. Plan de travail épaisseur 1,2 mm, doublé par panneau stratifié hydrofuge, et renforcé par un cadre en profilé. Bandeau hauteur 40 mm à bords droits. Piètement inox Ø 38 mm, en retrait à l'arrière de 55 mm sur les tables centrales et de 65 mm sur les tables à dossier. Plis écrasés sur le plan de travail, le dossier et l'étagère afin d'éviter tout risque de coupure. Montage très rapide par emboîtement.



Autres dimensions possibles, nous consulter. Tables inox sans étagère, nous consulter.



### Sans dossier. Avec étagère

			P.U.HT	Dont éco-participation
66002	E L. 100 x l. 70 cm	x 1	400,00 €	0,48 €
1003634	E L. 120 x l. 70 cm	x 1	415,00 €	0,59 €
1003635	E L. 140 x l. 70 cm	x 1	528,00 €	0,66 €

### A dossier. Avec étagère

			P.U.HT	Dont éco-participation
1003636	E L. 100 x l. 70 cm	x 1	490,00 €	0,48 €
1003637	E L. 120 x l. 70 cm	x 1	515,00 €	0,59 €
1003638	E L. 140 x l. 70 cm	x 1	534,00 €	0,66 €

## nouveau !

### Table de pré-tri des déchets

En acier inoxydable. Dessus épaisseur 15/10ème de mm doublé par panneau stratifié double face étanche comportant 2 ou 3 trous vide-déchets Ø 19-28 cm avec collerette caoutchouc gris. Piètement en tube inox Ø 45 mm équipé de vérins avec embouts anti-dérappants. Table livrée avec porte-sacs hauteur 80 cm sans couvercle, avec guidage. Bandeau rayonné avant et arrière.



### Table centrale 2 trous

			P.U.HT
1013485	L. 120 x l. 60 x H. 90 cm	x 1	1 108,00 €



### Table centrale 3 trous

			P.U.HT
1013486	L. 170 x l. 60 x H. 90 cm	x 1	1 364,00 €



## Armoire suspendue CHR

**TOURNUS**  
EQUIPEMENT

En acier inoxydable. Hauteur 60 cm. Portes coulissantes doublées suspendues sur un rail disposé en partie supérieure, avec butée de fin de course. Étagère intermédiaire réglable. Plis écrasés sur le bandeau, l'étagère, les poignées et le plancher. Fixation murale par 2 supports.

			P.U.HT	Dont Eco-participation
<b>65655</b>	E L. 120 x l. 40 cm	x 1	<b>675,00 €</b>	<b>0,72 €</b>
<b>65654</b>	E L. 140 x l. 40 cm	x 1	<b>745,00 €</b>	<b>0,83 €</b>
<b>65656</b>	E L. 180 x l. 40 cm	x 1	<b>902,00 €</b>	<b>1,04 €</b>



## Meuble avec dossieret CHR

**TOURNUS**  
EQUIPEMENT

En acier inoxydable. Hauteur réglable 90 à 96,5 cm. Dessus doublé par panneau stratifié hydrofuge. Dossieret plié hauteur 10 cm. Bandeau avant de hauteur 40 mm. Étagère réglable. Portes coulissantes doublées suspendues sur un rail disposé en partie supérieure, avec butée de fin de course. Piètement en polyamide avec vérins à filetage non apparent. Généralisation des plis écrasés afin d'éviter tout risque de coupure.

			P.U.HT	Dont Eco-participation
<b>65736</b>	E L. 120 x l. 70 cm	x 1	<b>1 353,00 €</b>	<b>1,58 €</b>
<b>65737</b>	E L. 140 x l. 70 cm	x 1	<b>1 404,00 €</b>	<b>1,76 €</b>
<b>65738</b>	E L. 180 x l. 70 cm	x 1	<b>1 611,00 €</b>	<b>2,07 €</b>



## Armoire haute

**TOURNUS**  
EQUIPEMENT

Construction soudée en acier inoxydable. Hauteur bord avant 180 cm/arrière 191 cm. Parois intérieures doublées. Portes coulissantes doublées. Toit incliné pour faciliter le nettoyage. 3 étagères réglables. Piètement Ø 60 mm avec vérins à filetage non apparent permettant un réglage de 50 mm.

			P.U.HT	Dont Eco-participation
<b>43041</b>	E L. 100 x l. 60 cm	x 1	<b>2 225,00 €</b>	<b>2,17 €</b>
<b>43042</b>	E L. 120 x l. 60 cm	x 1	<b>2 423,00 €</b>	<b>2,32 €</b>
<b>43043</b>	E L. 140 x l. 60 cm	x 1	<b>2 470,00 €</b>	<b>2,69 €</b>

nouveau !

## Meuble de pré-tri des déchets avec rampe à plateaux

**TOURNUS**  
EQUIPEMENT

En acier inoxydable. Dessus épaisseur 15/10ème de mm comprenant 2 ou 3 trous vide-déchets Ø 19-28 cm avec collerette en caoutchouc gris. Bandeau rayonné. Habillage des côtés et de l'avant à choisir parmi 20 teintes. Rampe à plateaux type self.



20 teintes disponibles, nous consulter



Meuble central 2 trous  
**1013483** L. 120 x l. 60 x H. 90 cm x 1 **2 511,00 €**

Meuble central 3 trous  
**1013484** L. 170 x l. 60 x H. 90 cm x 1 **2 905,00 €**





## Étagère pour micro-ondes

En acier inoxydable. Étagère à plateau, épaisseur 1,2 mm.  
Charge 100 kg répartis (suivant la nature de la paroi).  
Dossieret arrière H. 4 cm, en retrait du mur de 4 cm.  
Fixation murale par 4 vis. Poids 4,7 kg.

**TOURNUS**  
EQUIPEMENT

<b>1003412</b>	E L. 60 x l. 50 x H. 11 cm	x 1	<b>P.U.HT</b> <b>101,00 €</b>	Dont Éco-participation <b>0,14 €</b>
----------------	----------------------------	-----	----------------------------------	---



## Étagère à crémaillères 2 niveaux

En acier inoxydable.  
Charge 100 kg répartis (suivant la nature de la paroi).  
Plateaux réglables avec dossieret de hauteur 5 cm. Epaisseur 1,2 mm.  
Fixation par vis.  
Hauteur 70 cm, largeur 39 cm, pas 5,5 cm.

**TOURNUS**  
EQUIPEMENT

<b>65734</b>	L. 120 cm	x 1	<b>P.U.HT</b> <b>353,00 €</b>	Dont Éco-participation <b>0,32 €</b>
<b>65735</b>	L. 140 cm	x 1	<b>378,00 €</b>	<b>0,34 €</b>
<b>65732</b>	L. 180 cm	x 1	<b>447,00 €</b>	<b>0,45 €</b>



## Étagère murale CHR

En acier inoxydable. Étagère à plateau, épaisseur 1,2 mm.  
Charge 100 kg répartis (suivant la nature de la paroi).  
Dossieret arrière hauteur 4 cm, en retrait du mur de 4 cm.  
Fixation murale par 4 vis.  
Largeur utile 36 cm.  
Hauteur 20 cm.

**TOURNUS**  
EQUIPEMENT

<b>65739</b>	E L. 120 x l. 40 cm	x 1	<b>P.U.HT</b> <b>137,00 €</b>	Dont Éco-participation <b>0,14 €</b>
<b>65742</b>	E L. 160 x l. 40 cm	x 1	<b>176,00 €</b>	<b>0,19 €</b>

Produits pour l'hygiène des mains, voir page 489



## Lave-mains à dossieret

Dossieret inox. Livré avec accessoires (jupe inox, bec col de cigne, mélangeur eau chaude /eau froide, robinet temporisé, flexible et syphon).

**H.A.C.C.P.**

<b>70618P</b>	E L. 33 x l. 40 cm	x 1	<b>P.U.HT</b> <b>171,00 €</b>	Dont Éco-participation <b>0,13 €</b>
---------------	--------------------	-----	----------------------------------	---



## Table roulante

Construction soudée en acier inoxydable. 4 roues pivotantes Ø 8 cm, à chape en acier électrozingué, dont 2 avec freins.

**TOURNUS**  
EQUIPEMENT

<b>51372</b>	E L. 45 x l. 45 x H. 48 cm	x 1	<b>P.U.HT</b> <b>406,00 €</b>	Dont Éco-participation <b>0,14 €</b>
--------------	----------------------------	-----	----------------------------------	---

Idéal pour le rangement et le déplacement des appareils et machines en cuisine (trancheur, robot, coupe-pain...)  
Stockage possible.



Hauteur 48 cm





## Chariot porte-plateaux à niveau constant

**TOURNAIS**  
EQUIPEMENT

Construction en acier inoxydable, plate-forme 54 x 38 cm épaisseur 1,2 mm. Guidage de la partie mobile à l'aide de 4 galets montés sur roulements à billes. 4 roues pivotantes Ø 12,5 cm à chape polyamide dont 2 à frein. Butoirs de protection en polyéthylène moulé. Charge maximale 150 kg. Capacité 140 plateaux.

**60750** E L. 81,7 x l. 54,5 x H. 93 cm

 x 1

**P.U.HT**  
**990,00 €**

Dont Éco-participation  
**0,66 €**



Plateaux  
cafétéria,  
à partir de  
la page 241



## Chariot porte-plateaux

**SAINT ROMAIN**  
FABRICANT

Panier fils et structure inox.  
4 roues Ø 12,5 cm sans frein.  
Capacité 90 plateaux.

**43115** L. 69,7 x l. 54 x H. 91 cm

 x 1

**P.U.HT**  
**671,00 €**



## Chariot porte-plateaux

**TOURNAIS**  
EQUIPEMENT

Construction en acier inoxydable. Plateau inox amovible épaisseur 1,2 mm pour faciliter le nettoyage. Dossieret boulonné. Tube 25 x 25 mm. 4 roues pivotantes (Ø 12,5 cm) à chape polyamide dont 2 à frein. Avec pare-chocs annulaires. Charge maxi : 150 kg. Capacité 140 plateaux.

**60707** E Dim. hors tout 81,7 x 54,5 x 93 cm  
Dim. utile 75 x 51 cm

 x 1

**P.U.HT**  
**365,00 €**

Dont Éco-participation  
**0,24 €**





180 - 480 assiettes



## Chariot porte-assiettes

**CAMBRO**  
TRUSTED FOR GENERATIONS™

Chariot ajustable offrant une souplesse d'utilisation illimitée avec un design unique pour de multiples combinaisons d'assiettes, de bols et de plateaux. Une capacité exceptionnelle de 180 à 480 assiettes ou 45 à 60 assiettes par colonne (total de 6 colonnes). Conception ergonomique avec des poignées moulées qui font de cette unité, un chariot à la fois compact et facile à manoeuvrer. Paroi extérieure en polyéthylène, robuste, anticorrosion, indéformable, infissurable et inébréchable. Ce chariot possède 4 roues pivotantes de Ø 15,24 cm avec frein à chaque angle ainsi qu'une roue centrale rigide qui permet de faciliter le transport.

**1011740** E Capacité de 180 à 480 assiettes  
Dim. hors tout : L. 76,2 x l. 98,43 x H. 90,17 cm

 **P.U.HT** Dont Éco-participation  
x 1 **1 543,00 €** **4,80 €**



200 - 400 assiettes



## Chariot porte-assiettes

**TOURNUS**  
EQUIPEMENT

Chariot porte-assiettes réhaussé avec grilles de séparation anti-chute :

- Construction en acier inoxydable alimentaire.
- Arceaux en tube 25 x 25 mm.
- 4 roues pivotantes Ø 12,5 cm à chape polyamide dont 2 à frein, bandage non marquant.
- 2 grilles de séparation anti-chute réglables en fil d'acier inoxydable Ø 6 mm.
- Assiettes jusqu'à 29 cm.

**1002297** E Capacité 400 assiettes - Charge maxi 240 kg  
Dim. hors tout : L. 106,5 x l. 74 x H. 100 cm

 **P.U.HT** Dont Éco-participation  
x 1 **761,00 €** **0,53 €**

**1002296** E Capacité 200 assiettes - Charge maxi 120 kg  
Dim hors tout : L. 106,5 x l. 45 x H. 100 cm

x 1 **581,00 €** **0,35 €**

Plateforme réhaussée pour une utilisation plus ergonomique.



200 - 400 assiettes



## Chariot porte-assiettes

**TOURNUS**  
EQUIPEMENT

Chariot porte-assiettes avec grille de séparation anti-chute.

- En acier inoxydable.
- Arceaux en tube 25 x 25 mm avec séparations réglables.
- 4 roues pivotantes Ø 12,5 cm à chape polyamide avec roulement à billes dont 2 à frein.
- Pare-chocs annulaires.
- Assiettes jusqu'à 29 cm.

**60754** E Capacité 400 assiettes sans grille escamotable  
Dim. hors tout : L. 106,5 x l. 74 x H. 81 cm

 **P.U.HT** Dont Éco-participation  
x 1 **679,00 €** **0,49 €**

**60753** Capacité 200 assiettes sans grille escamotable  
Dim. hors tout : L. 106,5 x l. 45 x H. 81 cm

x 1 **500,00 €** **0,33 €**

**60745** E Capacité 200 assiettes avec grille avant escamotable  
Dim. hors tout : L. 106,5 x l. 45 x H. 81 cm

x 1 **384,00 €** **0,36 €**





## Chariot porte-bacs GN

**TOURNAIS**  
EQUIPEMENT

Chariot conçu pour l'égouttage et le stockage des bacs, grilles, plateaux et couvercles GN 1/1 et GN 1/2, après leur passage en plonge.  
Construction en acier inoxydable.  
Structure tube 25 x 25 mm soudée.  
Grilles amovibles pour faciliter le nettoyage, en fils inox Ø 6 et 4 mm.  
Deuxième niveau réglable pour le stockage éventuel de bacs GN 2/1.  
2 barres horizontales faisant office de butées facilement escamotables pour la mise en place des bacs.  
Pare-chocs annulaires.  
4 roues pivotantes Ø 12,5 cm à chape polyamide dont 2 à frein.

**63635** E L. 127 x l. 62 x H. 170,5 cm

 x 1 **P.U.HT** 1 785,00 €  
Dont Éco-participation 0,68 €



## Chariot pliant

Accueille tous types d'assiettes d'une hauteur maximale de 7 cm. 4 roues dont 2 à frein. Encombrement au sol 50 x 50 cm. Il se replie pour le rangement, accroché à un mur ou rangé dans un petit coin. Poids 18,5 kg.

**38509** Capacité 84 assiettes  
Dim. : 48 x 48 x H. 190 cm

 **GARANTIE 1 an**

 x 1 **P.U.HT** 1 174,00 €

### LES SYSTÈMES DE STOCKAGE POUR ASSIETTES GARNIES. SIMPLIFIEZ-VOUS LA VIE...

Gain de temps/gain de place : sur roues, mural ou posé sur table, vous préparez à l'avance et stockez un maximum d'assiettes dans un minimum d'espace.

Polyvalence astucieuse : toujours modulables, ils permettent le stockage et la distribution de tous types d'assiettes en diamètre ainsi qu'en hauteur.

Hygiène garantie : stockage des préparations hors contamination avec le système de housse de protection.

Nettoyage facile au jet ou à l'éponge.

Autres modèles, nous consulter.

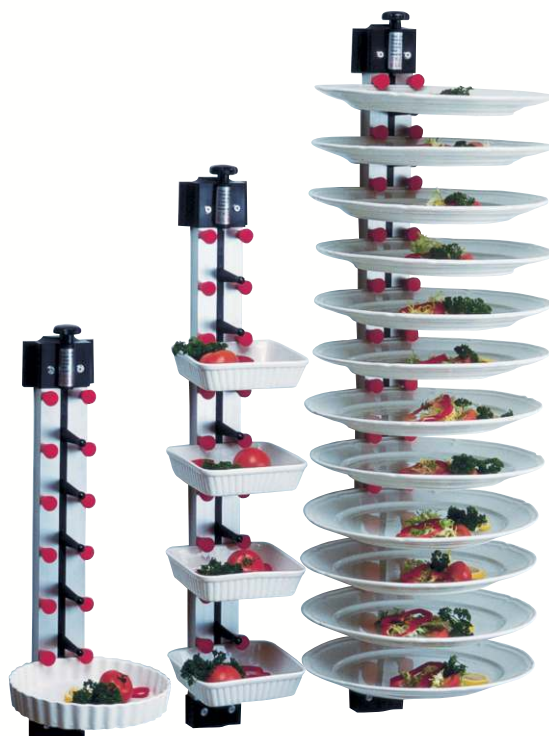

## Support mural

Accueille tous types d'assiettes d'une hauteur maximale de 7 cm. Fixation par œillet permettant un décrochage du système pour le nettoyage.

**42150** Capacité 6 assiettes - H. 63,5 cm  
**42151** Capacité 9 assiettes - H. 83,8 cm  
**42152** Capacité 12 assiettes - H. 99 cm

 **GARANTIE 1 an**

 x 1 **P.U.HT** 139,00 €  
x 1 **179,00 €**  
x 1 **221,00 €**





4377

### Chariot Euronorme



Construction en acier inoxydable.  
 Montants tubes carrés 25 x 25 mm.  
 Glissières soudées argon avec butées d'arrêt en extrémité.  
 4 roues pivotantes Ø 12,5 cm à chape acier électrozingué dont 2 à frein.  
 Pare-chocs annulaires. Livrés assemblés.

Nombre de niveaux	16 niveaux	16 niveaux
Entrée	40 cm	60 cm
Espace glissières	9,4 cm	9,4 cm
Dim Hors tout (L x l x H)	72,5 x 54 x 178,5 cm	52,5 x 73,2 x 178,5 cm
Référence	<b>4377</b>	<b>4376</b>
P.U.H.T	<b>332,00 €</b>	<b>328,00 €</b>
Dont Éco-participation	<b>0,39 €</b>	<b>0,35 €</b>



60749

Nombre de niveaux	20 niveaux
Entrée	40 cm
Espace glissières	7,5 cm
Dim Hors tout (L x l x H)	72,5 x 54 x 178,5 cm
Référence	<b>60749 €</b>
P.U.H.T	<b>342,00 €</b>
Dont Éco-participation	<b>0,41 €</b>

**1<sup>er</sup> PRIX**



### Chariot Euronorme

Construction en acier inoxydable.  
 Montants tubes carré 25 x 25 mm.  
 Pare-chocs annulaires pour plus de sécurité.  
 Livré en kit, montage aisé.

Nombre de niveaux	16 niveaux
Entrée	40 cm
Espace glissières	8,3 cm
Dim Hors tout (L x l x H)	69 x 54 x 170 cm
Référence	<b>70426P</b>
P.U.H.T	<b>310,00 €</b>
Dont Éco-participation	<b>0,33 €</b>



### Chariot encastrable 20 niveaux

Construction en acier inoxydable, encastrable en Z.  
Structure tube carré 25 x 25 mm, épaisseur 1.2 mm, soudures renforcées.  
Douilles inox soudées dans le tube. Glissières avec double butée soudées.  
4 roulettes polyamide Ø 12,5 cm, dont 2 avec frein.  
Pare-chocs annulaires.  
Livré assemblé.

	GN 1/1	GN 2/1
Entrée	32,5 cm	53 cm
Espace glissières	7,5 cm	7,5 cm
Dim Hors tout (L x l x H)	56,5 x 38,9 x 178,6 cm	68,5 x 59,4 x 178,6 cm
Références	<b>57068</b>	<b>57069</b>
P.U H.T	<b>407,00 €</b>	<b>449,00 €</b>



57068



60748



Plaques et grilles  
voir pages 442/443

### Chariot 20 niveaux

Construction en acier inoxydable.  
Montants tube carré 25 x 25 mm.  
Glissières soudées argon avec butées d'arrêt en extrémité.  
4 roues pivotantes Ø 12,5 cm dont 2 à frein.  
Pare-chocs annulaires.  
Livré assemblé.

	GN 1/1	GN 2/1
Entrée	32,5 cm	53 cm
Espace glissières	7,7 cm	7,7 cm
Dim Hors tout (L x l x H)	65,3 x 45,5 x 178,5 cm	77,3 x 66 x 178,5 cm
Référence	🛒 <b>60748 E</b>	<b>61348 E</b>
P.U H.T	<b>275,00 €</b>	<b>285,00 €</b>
Dont Éco-participation	<b>0,32 €</b>	<b>0,38 €</b>

## HOUSES



### Dériveur mural

Inox.

Dériveur housses jetables  **P.U. HT**  
**53546** E L. 101 x l. 19 cm x 1 **205,00 €**

Polyéthylène haute densité, translucide. Ép. 20 µ.

Rouleau de 200 housses jetables  **P.U. HT**  
**53545** E H. 180 cm x 1 **157,00 €**

### Housse jetable de protection

Pour chariot GN 2/1 et format pâtisseries.

Polyéthylène basse densité. Résistantes et transparentes. Ep. 26 µ.

Carton de 5 rouleaux de 20 housses  **P.U. HT**  
**1008681P** E L. 180 x l. 140 cm x 1 **66,00 €**



Plateau cafétéria,  
voir page 243



1<sup>er</sup> PRIX

**Chariot 16 niveaux**

Construction en acier inoxydable.  
Montants tubes carré 25 x 25 mm.  
Pare-chocs annulaires pour plus de sécurité.  
Livré en kit, montage aisé.



	<b>GN 1/1</b>
Entrée	32,5 cm
Espace glissières	8,5 cm
Dim Hors tout (L x l x H)	62 x 45 x 170,5 cm
Référence	<b>70425P</b>
P.U.H.T	<b>324,00 €</b>
Dont Éco-participation	<b>0,45 €</b>

**Chariot 8 niveaux**

Construction en acier inoxydable avec tablette.  
Montants tubes carrés 25 x 25 mm.  
Glissières soudées argon avec butées d'arrêt en extrémité.  
4 roues pivotantes Ø 12,5 cm, dont 2 à frein, à chape polyamide.  
Pare-chocs annulaires.  
Charge maxi : 20 kg par niveau.



	<b>GN 1/1</b>
Entrée	32,5 cm
Espace glissières	8,1 cm
Dim Hors tout (L x l x H)	65,6 x 45,7 x 90 cm
Référence	<b>1007388</b>
P.U.H.T	<b>248,00 €</b>
Dont Éco-participation	<b>0,23 €</b>



CHARIOTS CAFÉTÉRIA

**Chariot cafétéria 12 plateaux**

Espace entre glissières 11,5 cm, tube 25 mm. Fil tout inox. 4 roues sans frein. Pour plateaux 48 x 37 cm. Habillage latéral gris en polystyrène alimentaire 5 mm. Sangles élastiques amovibles pour le maintien des plateaux. Existe en GN 1/1.



	<b>Avec habillage</b>	<b>Sans habillage</b>
Sens d'entrée et dimension	longueur 48 x 37 cm	
Dimension	L. 53,5 x l. 61,5 x H. 176 cm	L. 53,5 x l. 61,5 x H. 176 cm
Référence	<b>43686</b>	<b>43117</b>
P.U.H.T	<b>778,00 €</b>	<b>587,00 €</b>
Dont Éco-participation	<b>1,11 €</b>	<b>0,38 €</b>

**Chariot cafétéria 24 plateaux**

Montures et glissières en acier inoxydable. Espacement entre les glissières 12,5 cm. 4 roues pivotantes en polyamide Ø 12,5 cm, dont 2 avec frein. Panneaux d'habillage : en stratifié beige. Livré monté. Pare-chocs annulaires. Clips anti-chute pour les plateaux à l'entrée de chaque niveau.



	<b>Avec habillage</b>	<b>Sans habillage</b>
Sens d'entrée et dimension	largeur 32 à 37 cm	
Dimension	L. 93 x l. 63 x H. 179 cm	L. 93 x l. 63 x H. 179 cm
Référence	<b>60747 E</b>	<b>60746 E</b>
P.U.H.T	<b>746,00 €</b>	<b>591,00 €</b>
Dont Éco-participation	<b>0,63 €</b>	<b>0,57 €</b>



nouveau !



**Éco Pain**

Chariot ouvert sur le dessus, comportant 3 côtés en acier inoxydable. A l'avant, une porte à guillotine en plexiglass, à poignée. Bac en polypropylène translucide sous la porte, pour la récupération et l'évacuation des morceaux de pain. Fond du chariot en acier inoxydable, incliné, pour faciliter l'évacuation. 4 roues pivotantes avec butoirs annulaires, dont 2 à frein.



**La solution éducative pour réduire le gaspillage du pain**

L'Éco pain a été conçu comme un outil incitatif pour apprendre au personnel et aux élèves à maîtriser et diminuer la quantité non consommée. Comporte deux curseurs qui permettent d'indiquer le niveau actuel (rouge) et celui à atteindre (vert).



	<b>Chariot</b>
Dim Hors tout (L x l x H)	66,4 x 46,8 x 120 cm
Référence	<b>1013555</b>
P.U.H.T	<b>994,00 €</b>



Dimensions plateau  
100 x 60 cm



## Chariot de service inox



Construction en acier inoxydable.  
Plateaux emboutis avec bords écrasés, insonorisés.  
Arceaux tube Ø 2,5 cm.  
4 roues pivotantes Ø 12,5 cm à chape polyamide dont 2 à frein. Pare-chocs annulaires.  
Bandage caoutchouc non marquant.  
Espacement entre les plateaux : 56 cm pour les 2 plateaux, 26 cm pour le 3 plateaux.  
Charge maxi : 50 kg par niveau.

L. 109,5 x 69,5 x H. 96 cm

**1002180** E 2 plateaux  
**1002181** E 3 plateaux

☐ x 1  
x 1

**P.U.HT** Dont Éco-participation  
**292,00 €** **0,39 €**  
**307,00 €** **0,52 €**



Dimensions plateau  
80 x 53 cm



L. 89,5 x l. 62,5 x H. 96 cm

**60743** E 2 plateaux  
**60744** E 3 plateaux



☐ x 1  
x 1

**P.U.HT** Dont Éco-participation  
**270,00 €** **0,28 €**  
**297,00 €** **0,37 €**

### 1<sup>er</sup> PRIX

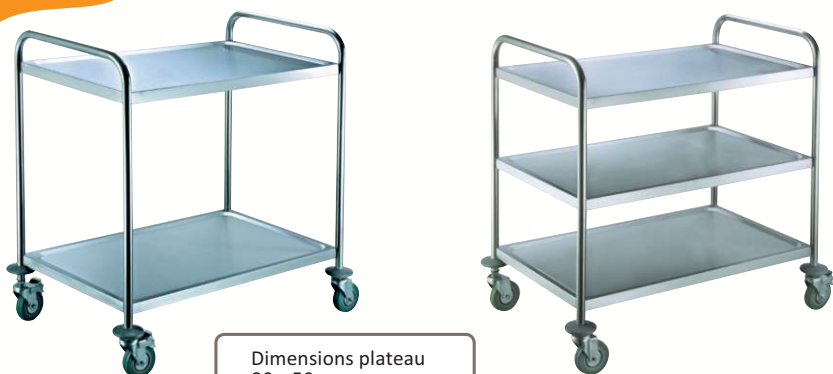

Dimensions plateau  
80 x 50 cm  
Livré en kit



## Chariot de service inox

Chariot en inox avec absorbeur de son.  
4 roues directrices Ø 10 cm dont 2 à frein.  
Pare-chocs annulaires.  
Charge maxi : 40 kg par niveau.  
Livré en kit, montage aisé.  
Espacement entre les plateaux :  
57 cm pour le 2 plateaux.  
27 cm pour le 3 plateaux.

L. 85,5 x l. 53,5 x H. 92,5 cm

**70423P** 2 plateaux  
**70424P** 3 plateaux



☐ x 1  
x 1

**P.U.HT** Dont Éco-participation  
**201,00 €** **0,25 €**  
**220,00 €** **0,33 €**



65653



65652



66001

## Accessoires pour chariot de service

Bac à déchets inox 15 L

**65653** E Crochetable sur les chariots de service.  
42 x 20 x 25 cm

☐ x 1

**P.U.HT**  
**108,00 €**

Bac à couverts inox 7 L

**65652** E Amovible et crochetable sur l'arceau des chariots de service.  
32,5 x 17,6 x 20 cm

☐ x 1

**P.U.HT**  
**76,50 €**

Support sac poubelle inox 70 L

**66001** E Amovible et crochetable sur l'arceau des chariots de service.  
36 x 35,5 x 81 cm

☐ x 1

**P.U.HT**  
**130,00 €**



## Chariot de service polypropylène **CAMBRO** TRUSTED FOR GENERATIONS™

Chariot de service polyvalent et durable.  
Les étagères (L. 80 x l. 52 cm) légèrement granité munies de rambardes empêchent le contenu de tomber.  
Les montants en aluminium assurent la stabilité.  
4 roues Ø 12,7 cm pivotantes.  
Livré démonté : assemblage aisé.  
Charge maximum: 180 Kg.  
Coloris noir.

**Chariot 3 plateaux**  **P.U.HT**  
**65398P** E L. 95 x l. 54 x H. 101,5 cm x 1 **322,00 €**  
Dont Éco-participation 1,26 €



Avec un jeu de 3 panneaux



**65403P**



Avec 2 jeux de 3 panneaux



**65460P**



**65397P**

## Accessoire pour chariot de service **CAMBRO** TRUSTED FOR GENERATIONS™

**Jeu de 3 panneaux d'étagères noirs**  **P.U.HT**  
En polypropylène. Panneaux optionnels à ajouter durant le montage, pour fermer une étagère sur 3 cotés.  
**65403P** E L. 80,3 x l. 45 x H. 30 cm x 1 **99,50 €**  
Dont Éco-participation 0,02 €

**Panier à couverts 9,5 L noir**  **P.U.HT**  
**65460P** E L. 33 x l. 24 x H. 18,5 cm x 1 **51,50 €**

**Poubelle 30 L noire**  **P.U.HT**  
**65397P** E L. 33 x l. 24 x H. 56 cm x 1 **92,50 €**

## 1<sup>er</sup> PRIX



## Chariot de service polypropylène

Construction en plastique : utilisation silencieuse.  
Poignées ergonomiques.  
Surface lisse : nettoyage facile.  
3 plateaux de 75 x 49 cm.  
Hauteur entre chaque tablette : 29 cm.  
4 roues pivotantes Ø 10 cm.  
Charge maximum : 90,7 kg.  
Coloris noir.

**3 plateaux**  **P.U.HT**  
**64373P** E L. 103 x l. 50,5 x H. 94 cm x 1 **166,00 €**  
Dont Éco-participation 1,11 €

Ergonomique et maniable  
Facile à entretenir  
Robuste et léger  
3 niveaux





## Chariot petit déjeuner



Structure polyéthylène monobloc.  
Design contemporain, légèreté, maniabilité, solidité, silencieux.  
Ce chariot, facile à nettoyer, dispose d'un plan de travail spacieux et de 2 poignées inox pour une fermeture totale.  
Capacité : 12 plateaux GN1/1 ou 24 plateaux GN1/2 + 2 niveaux pour bacs.  
Espace entre glissières : 98 mm.

L. 101 x l. 65 x H. 110 cm			<b>P.U.HT</b>
<b>1000112</b> E Noir	x 1		<b>1 433,00 €</b>
<b>1000110</b> E Framboise	x 1		<b>1 433,00 €</b>
<b>1000111</b> E Bleu	x 1		<b>1 433,00 €</b>
Dont Éco-participation 3,52 €			



Des accessoires sont disponibles en option : tablette de préparation, support poubelle inox avec poubelle 25 L, 2 roues à frein.

<b>Tablette de préparation</b>			<b>P.U.HT</b>
<b>1000114</b> E L. 51 x l. 41 x H. 14 cm	x 1		<b>146,00 €</b>

<b>Support poubelle inox avec poubelle 25 L</b>			<b>P.U.HT</b>
<b>1000115</b> E L. 48,5 x l. 28 x H. 55 cm	x 1		<b>81,50 €</b>

<b>Deux roues à frein</b>			<b>P.U.HT</b>
<b>1000113</b> E Ø 12,5 cm	x 1		<b>20,00 €</b>



## Chariot petit-déjeuner sans porte



Structure polyéthylène monobloc.  
Chariot composite pour plateaux préparés sur place.  
Comprenant un panier inox pour le pain et les croissants et une galerie inox pour les verres et les bols.  
Tablette + support sac complet. 2 roues fixes Ø 16 cm.  
2 roues directionnelles composite sans frein Ø 12,5 cm.  
3 rayons espace 27 cm.  
Dimensions utiles des rayons : 70 x 46 cm.  
Dimensions utiles du dessus du chariot : 44 x 43 cm et 46 x 20 cm.  
Dimensions replié : L. 118,4 x P. 56,5 x H. 126 cm.  
Bac à couverts amovible.

<b>52431</b> E L. 159 x P. 56,5 x H. 126 cm			<b>P.U.HT</b>
	x 1		<b>1 252,00 €</b>
Dont Éco-participation 4,34 €			

Une tablette de travail pour la préparation des plateaux.  
Possibilité de rabattre la tablette et le support sac, pour le stockage ou la circulation dans les passages étroits.



Les casiers "CAMRACK" ont des parois pleines et anti-éclaboussures, permettant de maintenir l'eau pour assurer un nettoyage rigoureux. Empilage parfait. Poignées et bords arrondis facilitent la manipulation sans risque. Ces casiers de couleurs vous permettent une identification par secteur, par type de produit ou par destination. Le couvercle, légèrement bombé, augmente la rigidité et l'efficacité de la fermeture. Il permet de fermer hermétiquement pour le stockage après lavage (les housses de protection encombrantes s'accrochent, se déchirent ou traînent sur le sol). La conception en nid d'abeilles protège la verrerie fine, les délicats verres à pied, des fêlures et des ébrèchures. Ils sont conçus pour contenir 20 % de verre en plus que les casiers comparables à compartiments carrés et réduisent ainsi l'espace de stockage.



**CAMBRO**  
TRUSTED FOR GENERATIONS™

## Casier verres Camrack

En polypropylène 50 x 50 cm. Vendu à l'unité.



1.



2.



3.



4.



5.



6.



7.



8.



9.

Chariots pour casiers  
voir page 352



### 1. Casier 9 compartiments (gris/marron)

Diamètre maxi (cm)	14,8	14,8	14,8	14,8	14,8	14,8
Hauteur maxi (cm)	9	13,2	17,4	21,6	25,8	30
Hauteur casier (cm)	14,3	18,4	22,5	26,7	30,8	34,9
Référence	<b>66096</b>	<b>66097</b>	<b>66098</b>	<b>66099</b>	<b>66100</b>	<b>66095</b>
P.U H.T	<b>35,75 €</b>	<b>47,25 €</b>	<b>51,50 €</b>	<b>62,50 €</b>	<b>72,50 €</b>	<b>84,00 €</b>

### 2. Casier 16 compartiments (gris/rouge)

Diamètre maxi (cm)	10,9	10,9	10,9	10,9	10,9	10,9
Hauteur maxi (cm)	9	11	13,2	15,2	17,4	19,4
Hauteur casier (cm)	14,3	14,3	18,4	18,4	22,5	22,5
Référence	<b>66134</b>	<b>66139</b>	<b>66135</b>	<b>66104</b>	<b>66105</b>	<b>66106</b>
P.U H.T	<b>32,50 €</b>	<b>34,00 €</b>	<b>42,50 €</b>	<b>43,50 €</b>	<b>51,50 €</b>	<b>52,50 €</b>

Diamètre maxi (cm)	10,9	10,9	10,9	10,9	10,9	10,9
Hauteur maxi (cm)	21,6	23,8	25,8	27,8	30	32
Hauteur casier (cm)	26,7	26,7	30,8	30,8	34,9	34,9
Référence	<b>66136</b>	<b>66137</b>	<b>66138</b>	<b>66101</b>	<b>66102</b>	<b>66103</b>
P.U H.T	<b>62,00 €</b>	<b>63,00 €</b>	<b>71,50 €</b>	<b>72,50 €</b>	<b>83,00 €</b>	<b>84,00 €</b>

### 3. Casier 20 compartiments (gris/rouge cerise)

Diamètre maxi (cm)	9,84	9,84	9,84	9,84	9,84	9,84
Hauteur maxi (cm)	9	13,3	17,5	21,6	25,8	30
Hauteur casier (cm)	14,3	18,4	22,5	26,7	30,8	34,9
Référence	<b>70093</b>	<b>70094</b>	<b>70095</b>	<b>70096</b>	<b>70097</b>	<b>70098</b>
P.U H.T	<b>32,50 €</b>	<b>43,25 €</b>	<b>52,00 €</b>	<b>62,00 €</b>	<b>71,50 €</b>	<b>83,00 €</b>

### 4. Casier 25 compartiments (gris/bleu)

Diamètre maxi (cm)	8,7	8,7	8,7	8,7	8,7	8,7
Hauteur maxi (cm)	9	11	13,2	15,2	17,4	19,4
Hauteur casier (cm)	14,3	14,3	18,4	18,4	22,5	22,5
Référence	<b>66141P</b>	<b>66140P</b>	<b>66144P</b>	<b>66142</b>	<b>66143P</b>	<b>66145P</b>
P.U H.T	<b>35,50 €</b>	<b>33,00 €</b>	<b>39,75 €</b>	<b>42,50 €</b>	<b>47,50 €</b>	<b>53,00 €</b>

Diamètre maxi (cm)	8,7	8,7	8,7	8,7	8,7	8,7
Hauteur maxi (cm)	21,6	23,8	25,8	27,8	30	32
Hauteur casier (cm)	26,7	26,7	30,8	30,8	34,9	34,9
Référence	<b>66146P</b>	<b>66147</b>	<b>66110</b>	<b>66107</b>	<b>66108</b>	<b>66109</b>
P.U H.T	<b>58,50 €</b>	<b>63,50 €</b>	<b>67,50 €</b>	<b>73,50 €</b>	<b>78,50 €</b>	<b>84,50 €</b>

### 5. Casier 30 compartiments (gris/noir)

Diamètre maxi (cm)	7,94	7,94	7,94	7,94	7,94	7,94
Hauteur maxi (cm)	9,2	13,3	17,5	21,6	25,8	30
Hauteur casier (cm)	14,3	18,4	22,5	26,7	30,8	34,9
Référence	<b>70099</b>	<b>70100</b>	<b>70101</b>	<b>70102</b>	<b>70103</b>	<b>70104</b>
P.U H.T	<b>34,00 €</b>	<b>43,50 €</b>	<b>53,00 €</b>	<b>63,00 €</b>	<b>73,00 €</b>	<b>83,00 €</b>

### 6. Casier 36 compartiments (gris)

Diamètre maxi (cm)	7,2	7,2	7,2	7,2	7,2	7,2
Hauteur maxi (cm)	9	11,4	13,2	15,2	17,4	19,4
Hauteur casier (cm)	14,3	14,3	18,4	18,4	22,5	22,5
Référence	<b>56150P E</b>	<b>45604 E</b>	<b>56151 E</b>	<b>66114P</b>	<b>56153P E</b>	<b>56154 E</b>
P.U H.T	<b>31,75 €</b>	<b>36,75 €</b>	<b>41,00 €</b>	<b>44,50 €</b>	<b>48,75 €</b>	<b>55,50 €</b>

Diamètre maxi (cm)	7,2	7,2	7,2	7,2	7,2	7,2
Hauteur maxi (cm)	21,6	23,8	25,8	27,8	30	32
Hauteur casier (cm)	26,7	26,7	30,8	30,8	34,9	34,9
Référence	<b>66115</b>	<b>66117</b>	<b>66116</b>	<b>66111</b>	<b>66112</b>	<b>66113</b>
P.U H.T	<b>63,00 €</b>	<b>66,00 €</b>	<b>69,50 €</b>	<b>76,00 €</b>	<b>78,50 €</b>	<b>86,00 €</b>

### 7. Casier 49 compartiments (gris/vert)

Diamètre maxi (cm)	6	6	6	6	6	6
Hauteur maxi (cm)	9	13,2	17,4	21,6	25,8	30
Hauteur casier (cm)	14,3	18,4	22,5	26,7	30,8	34,9
Référence	<b>66123</b>	<b>66122</b>	<b>66121</b>	<b>66120P</b>	<b>66119</b>	<b>66118</b>
P.U H.T	<b>34,50 €</b>	<b>44,75 €</b>	<b>54,00 €</b>	<b>58,50 €</b>	<b>74,50 €</b>	<b>86,00 €</b>

### 8. Couvercle pour casier

Protège les verres par le haut		P.U.H.T
<b>45605P</b> E L. 49,9 x l. 49,9 x H. 2,4 cm	x 1	<b>60,00 €</b>

### 9. Clip d'identification pour casier

ABS.		P.U.H.T
<b>1011749</b>	x 6	<b>1,80 €</b>





## Casier à assiettes

**CAMBRO** PP  
TRUSTED FOR GENERATIONS™ POLYPROPYLENE

Dans un sens, il permet de placer les assiettes ordinaires et, dans l'autre sens, les assiettes creuses, bols et cloches. Capacité en configuration à 5 compartiments : 10 bols, assiettes creuses, plats ou cloches de 25,4 cm. Capacité en configuration à 9 compartiments : 18 assiettes de 25,4 cm ou 12 assiettes de 30,5 cm ou 27 assiettes de 19 cm ou 9 plateaux de 36 x 46 cm.

Casier à plats sans extension  
5 x 9 rangées  
65379P E L. 50 x l. 50 x H. 10,1 cm x 1 **22,75 €**

Casier à plats avec extension  
5 x 9 rangées  
50597 E L. 50 x l. 50 x H. 14,3 cm x 1 **46,25 €**



## Casier à objets creux

**CAMBRO** PP  
TRUSTED FOR GENERATIONS™ POLYPROPYLENE

52497P E L. 50 x l. 50 x H. 14,9 cm x 1 **67,00 €**



## Casier ouvert

**CAMBRO** PP  
TRUSTED FOR GENERATIONS™ POLYPROPYLENE

Idéal pour laver, ranger les plateaux de service ou les plaques de cuisson GN1/1. Grâce à son côté ouvert, il est facile de placer et d'enlever les plateaux de toutes longueurs. Capacité : 9 plateaux en position verticale.

50647P E L. 50 x l. 50 x H. 8,2 cm x 1 **37,50 €**



## Panier à couverts

PP  
POLYPROPYLENE

8 compartiments.  
65030P E L. 42,7 x l. 20,8 x H. 15,1 cm x 1 **37,25 €**



## Casier à couverts vrac

**VOLLRATH** PP  
Outperform every day™ POLYPROPYLENE

36048P E 50 x 50 x H. 10,5 cm x 1 **22,75 €**



## Godet à couverts

**VOLLRATH**  
Outperform every day™

En polypropylène.  
Carré  
45394P E L. 11 x l. 11 x H. 14 cm x 1 **4,00 €**



En plastique blanc.  
Rond  
38504P E Ø 9,5 x H. 14,3 cm x 1 **3,80 €**



# Verres à pied

Code Verre	PRODUIT	Page catalogue	Cont (cl)	Haut (cm)	Diam (cm)	Code Casier
1005396	Ais	153	43,5	22	8,5	66147
69662	Allegro	150	35	21,9	5,9	66119
69663	Allegro	150	27	20,2	5,6	66120
1007017	Allegro	150	45	23,4	8,3	66147
69664	Allegro flûte	150	16	22,4	4,4	66119
33797	Amelia	149	16	10,1	6,9	45604
33798	Amelia	149	19	10,6	7,2	45604
33799	Amelia	149	25	11,7	7,9	70100
40056	Amelia	149	32	12,5	8,5	66144
64270	Arom'up	137	43	21,5	9,1	66137
64271	Arom'up	137	35	19,5	8,3	66146
1005715	Arom'up	137	25	17,8	7,6	70102
1007069	Arom'up	137	60	24,1	10,1	66138
65359	Arom'up flûte	137	21	21,1	7,4	70102
1005642	Artois	152	23,7	11	7,8	45604
1005643	Artois	152	21,5	12,6	8,3	66144
59513	Aurum	146	43	21,3	8,95	70096
59516	Aurum	146	35	20,3	8,3	66146
59514	Aurum flûte	146	23	23,5	6,8	66117
1530	Ballon	152	19	13	7,7	70100
1531	Ballon	152	15	11,8	7,1	56151
1532	Ballon	152	14	11,3	6,8	56151
1533	Ballon	152	10	10,2	6,2	45604
1534	Ballon	152	13	10,4	8,8	66139
65363	Ballon	152	25	13,8	8,3	66142
1000577	Brio	171	9,5	17,1	5,6	66121
1001634	Brio	171	16	19,8	6,5	66115
69665	Bubble	171	15	16,3	4,9	66121
53579	Cabernet cocktail	170	22	17,2	11,6	66098
53580	Cabernet cocktail	170	30	18,8	12	66099
1000533	Cabernet	143	16	22,5	7	66117
1000534	Cabernet	143	58	23	9,5	66137
1000535	Cabernet	143	19	16,5	6,6	56153
1003336	Cabernet	153	35	20,2	8,1	66146
1008177	Cabernet multi-usages	170	35	17,2	7,4	70101
50146	Cabernet	143	47	22	9	66137
50147	Cabernet	143	35	20,2	8,1	66146
50148	Cabernet	143	25	18	7,2	56154
50149	Cabernet	142	70	22,1	11,5	66137
50150	Cabernet	142	58	20,9	10,5	66136
50151	Cabernet	142	47	19,6	10	66136
50152	Cabernet	142	35	18,2	9,1	70096
62710	Cabernet coupe	170	30	17	12	66098
62714	Cabernet	142	35	20	9	70096
62715	Cabernet	142	47	21,5	9,7	70096
62726	Cabernet	142	58	22,3	10,4	66137
47350	Champagne	171	22	10	7,8	66140
40009	Charente	170	51	18,4	9,7	66106
59518	Colosseo	149	28	13,7	8,2	66142
59519	Colosseo	149	22	12,4	7,4	70100
35668	D.O.C.	144	41	18,2	7,9	56154
35669	D.O.C.	144	31	17,4	7,3	66143
35670	D.O.C.	144	21,5	15,5	6,5	56153
35671	D.O.C.	144	12	13,6	6	66122
55706	D.O.C.	153	21,5	15,5	6,5	56153
40127	Dortmund	173	37	24,3	7,6	66110
69203	Dream	171	14,2	19	5,4	66120
1502	Elégance	150	31	18	8,1	66145
1503	Elégance	150	24,5	16,6	7,4	70101
1504	Elégance	150	19	15,3	6,9	66114
1505	Elégance	150	14,5	14,2	6,4	66114
50655	Elégance	150	12	13,4	5,9	66121
53537	Elégance	150	19	15,3	6,9	66114
53538	Elégance	150	24,5	16,6	7,4	70101
1506	Elégance flûte	150	13	17,9	5,8	66120
2154	Elégance flûte	150	10	15,9	5,8	66121
31659	Elégance flûte	150	17	17,5	5,8	66120
45482	Elisa	148	30	19,4	7,6	70102
45483	Elisa	148	23	17,6	7,1	56154
45484	Elisa	148	18	16,6	6,5	56153
62406	Elisa	148	23	8,2	7,1	56150
45485	Elisa flûte	148	16	19,2	6,3	56154
64207	Grands cépages	141	24	23,5	7	66117
64209	Grands cépages	141	47	22,7	9,5	66137
64210	Grands cépages	141	62	23,8	10,1	66137
65355	Grands cépages	141	35	21	8,5	66146
1005716	Grands cépages	141	25	18,5	7,7	70102
63534	Hawai	170	44	21,5	8,6	66146
1013150	Héritage	170	26	13,2	11,05	sur demande
57163	Hurricane	170	25	19,5	7,1	56154
57164	Hurricane	170	44	20,8	7,9	66146
71204	Kalix	147	27	18	7,7	70102
71205	Kalix	147	17	19,6	5,8	66120
71206	Kalix	147	22	16,9	7,7	70101
1000536	Kyoto	170	31	17,9	8,1	66145
57201	Linéal	147	31	19,6	8,2	66146
57202	Linéal	147	19	16,4	7	56153
57203	Linéal	147	25	17,4	7,6	70102
1008185	Linéal	147	45	21,5	9,3	70096
57204	Linéal flûte	147	18	18,9	6,2	56154
1011427	Macaron	139	40	20	9,3	70096
1011426	Macaron	139	50	21,5	10	66137
1011428	Macaron	139	30	19,5	8,1	66146

Code Verre	PRODUIT	Page catalogue	Cont (cl)	Haut (cm)	Diam (cm)	Code Casier
1013250	Macaron fascination	139	60	22,8	10,8	sur demande
1013251	Macaron fascination	139	50	21,5	10,3	66136
1013252	Macaron fascination	139	40	20	9,5	70096
1013253	Macaron fascination	171	30	19,1	9,5	70096
1013256	Macassar	136	25	19,7	8,3	66146
1013292	Macassar	136	35	20,8	9,3	70096
1013293	Macassar flûte	136	17	23,3	6,1	66117
1005728	Margarita	170	27	16	10,8	66105
1476	Michelangelo	144	22,5	17,5	7,3	66145
1477	Michelangelo	144	19	16,6	6,7	66121
31645	Michelangelo	144	34	18,8	8,2	66145
65390	Michelangelo	144	31	14,6	6,3	66114
65391	Michelangelo	144	34,5	10,9	8	66140
1013243	Michelangelo coupe	170	22,5	14	9,55	66104
1478	Michelangelo flûte	154	16	18,5	6,4	66120
1479	Michelangelo flûte	154	11,5	8,2	6	66123
1487	Napoli	151	24	14,2	7,2	66114
1488	Napoli	151	18	12,5	6,55	66122
1489	Napoli	151	12	11,2	6	66122
1490	Napoli flûte	151	15	15,6	5,7	66121
1008178	New Martini	170	21	17,9	11,4	66099
31664	Normandie	148	11	12,7	5,9	66122
53539	Normandie	148	16	14,5	6,7	66114
53540	Normandie	148	24	16,2	7,4	70101
1548	Normandie flûte	148	14	17,3	5,4	66121
62388	Œnologue expert	138	45	21,6	8,7	66147
62389	Œnologue expert	138	35	20,2	8	66146
62404	Œnologue expert	138	26	18,5	7,1	56154
49701	Onyx	149	26	15,9	7,3	70101
49703	Onyx	149	20	15,1	6,8	66114
59491	Open up	137	37	21,1	9,6	70096
59492	Open up	137	47	22,8	10,3	66137
59493	Open up	137	40	22,3	9,1	70097
59495	Open up	137	55	23,3	10,7	66137
61563	Open up	137	32	18	8,7	66145
59490	Open Up flûte	137	20	23,4	7,4	70103
70209	Open up Arabesque	138	40	23,1	8,9	66137
70445	Open up Arabesque	138	55	23,3	10,7	66137
1002655	Open up Arabesque	138	37	21,1	9,6	70096
70210	Open up Arabesque flûte	138	20	23,4	7,4	70103
63531	Open up Spirit	172	16,5	17	7	56153
65357	Open up Spirit	172	39	13,2	10,4	66135
43451	Princesa	148	31	19,3	8,1	66145
43452	Princesa	148	23	17,4	7,4	70102
43453	Princesa	148	19	16,8	6,9	56153
43454	Princesa	148	14	15,5	6,3	66114
43455	Princesa flûte	148	16	19,6	6,4	66115
1011424	Resto	149	16	10,6	6,4	45604
1011425	Resto	149	25	12,6	7,6	70100
1006220	Reveal Up	136	55	23,4	11	66137
1006221	Reveal Up	136	45	22	10,4	66137
1006222	Reveal Up	136	40	23	9,1	70097
1006223	Reveal Up	136	30	21,5	8,3	66146
1006224	Reveal Up	136	50	24,5	9,7	70097
1006602	Reveal Up	136	40	22,5	9,2	70097
1006603	Reveal Up	136	45	21,5	10,7	66136
1006219	Reveal Up flûte	136	21	23	6,5	66117
48559	Rubino	145	21	15,5	6,7	66114
48560	Rubino	145	37	18,1	8,1	66145
48562	Rubino	145	27,6	17,2	7,3	56153
1499	Savoie	151	24,5	15,2	7,4	70101
1500	Savoie	151	19	14	6,9	66114
1501	Savoie	151	15	13,4	6,4	66114
40055	Savoie flûte	151	17	17	6,1	66121
60408	Sensation Exalt	143	41	20,5	8,6	66146
60409	Sensation Exalt	143	31	19,5	8	66145
60410	Sensation Exalt	143	25	18,5	7,4	70102
60411	Sensation Exalt	143	20	18	7,2	56154
60412	Sensation Exalt flûte	143	19	21	7	66115
1007730	Sublym	141	55	26	5,8	66118
1007731	Sublym	141	45	25	5,8	66119
1007732	Sublym	141	35	23	8	66147
1007733	Sublym	141	25	20,7	7,2	70102
1013255	Sublym Multi-usage	141	35	17,7	8	66145
1007734	Sublym flûte	141	21	24	6,5	66116
1011382	T Glass	145	35	13,1	7,9	66142
1011383	T Glass	145	27	15,7	6,9	56153
1011381	T Glass	145	44	14	8,4	66142
1013245	T Glass	145	61	14	10,6	66104
1006198	Tre Sensi	146	55	23,5	9,15	70097
1006199	Tre Sensi	146	43	22	8,5	66147
1006200	Tre Sensi	146	35	20,4	7,65	70102
1005322	Uno	146	64	24,3	10,4	66138
1005323	Uno	146	56	23,3	10	66137
1005324	Uno	146	47	22	9,5	70097
1005325	Uno	146	38	20,7	8,9	70096
1005326	Uno flûte	146	28	24,3	6,7	66116
51091	Vigne	172	7	14,5	5,4	66121
1007464	Vina	151	36	20,2	8	66146
1007465	Vina	151	48	21,8	8,6	66147
43467	Viticole	150	21,5	15,5	4,6	66121
57108	Viticole	150	31	17,5	5,4	66120
60088	Viticole jaugé	153	22	15,5	6,5	56153
65304						



# Gobelets forme Haute et Basse

Code Verre	PRODUIT	Page catalogue	Cont (cl)	Haut (cm)	Diam (cm)	Code Casier
56799	Ametista	154	34	9,5	8	66140
57000	Ametista	154	46	12	8,5	66144
1011608	Architecte	163	28	12	10,8	66135
1011610	Architecte	163	36	12,95	8,45	66144
1011609	Architecte	163	32	9,9	9,4	70094
1011480	Arpège	155	35	10,2	8,1	66140
1011481	Arpège	155	35	10,2	8,1	66140
1009585	Artic	160	22	8,5	6,8	56150
1009584	Artic	160	22	8,5	6,8	56150
1009583	Artic	160	22	8,5	6,8	56150
1009586	Artic	160	22	8,5	6,8	56150
64375	Atoll	123	25	7,05	9	70093
59509	Aurum	155	36	9,5	8,2	66140
1005095	Baya	157	30	10	8,4	66140
1005096	Baya	157	30	10	8,4	66140
1005097	Baya	157	30	10	8,4	66140
1005098	Baya	157	30	10	8,4	66140
1005099	Baya	157	30	10	8,4	66140
1005100	Baya	157	30	10	8,4	66140
1011433	Be Bop	167	35	14,2	6,9	66114
1011434	Be Bop	167	30	8,2	8,4	66141
1013247	Be Bop	167	21	5,9	8,2	66141
1011415	Broadway	163	38	14,5	7,5	70101
1011416	Broadway	163	28	13,4	6,75	66114
1011417	Broadway	163	30	9,1	8,45	66141
1013440	Calypso	164	48	16	8,1	66117
1013441	Calypso	164	35	10,6	8,2	66143
1797	Campus	161	22	12,8	6,4	56151
1798	Campus	161	18	8,5	6,5	56150
40128	Campus	161	29	12,6	6,5	56151
68560	Concerto	165	26	9	8,5	66141
69680	Concerto	165	40	14	8,4	66142
61561	Conique	169	25	10,7	6,8	45604
61562	Conique	169	28	11,6	7	56151
71207	Diamond	160	30,5	9,2	8,4	66140
71208	Diamond	160	30,5	9,2	8,4	66140
71209	Diamond	160	30,5	9,2	8,4	66140
1005344	Diamond	165	30,5	9,2	8,4	66140
35711	Disco	169	34	14	6,8	66114
35712	Disco	169	29	9,3	7,6	66144
35713	Disco	169	21	8,5	6,9	66123
43482	Disco	169	27	15,9	5,7	66121
1010731	Dolomiti	165	29	9	8,7	70093
1010732	Dolomiti	165	42	14	8,4	66142
1013213	Dolomiti	165	22	8,4	8	66141
62406	Elisa	156	23	8,2	7,1	56150
1000531	Elisa	156	19	10,8	5,6	66122
1012606	Este	164	40	10,7	8,9	70094
1013002	Este	164	30	8,5	8,9	70093
1013003	Este	164	29	14	7,2	70099
1008021	Eskale	167	31	8,7	9	70093
1008022	Eskale	124	18	7,8	7,7	70099
1008020	Eskale	167	42	9,6	9,7	66139
1011442	Fusion	167	35	12	8,2	66144
31709	Forum	161	16	6,5	6	66123
48627	Forum	161	23	7,5	7,5	70099
70183	Friends	165	31,5	9,8	9,8	66139
70184	Friends	165	34,4	13,9	8	66142
1002547	Gem	163	32	8,5	9,3	70093
1002548	Gem	163	35	14	7,8	66142
69316	Gigogne	161	16	6,9	7,1	56150
69317	Gigogne	161	22	7,7	8	66141
69334	Gigogne	126	9	6,01	5,8	66123
40129	Granity	168	36	12,2	8,5	66144
40130	Granity	168	31	14	7,5	70101
43490	Granity	168	27,5	9,8	8,5	66140
43491	Granity	168	20	12,5	6,5	56151
50005	Granity	168	46	16	8,7	70095
51113	Granity	168	16	7,3	7,3	70099
1005755	Granity	168	31	14	7,5	70101
1011451	Granity	168	35	10,7	9,25	66139
65286	Habana	161	17	7,5	7	56150
65287	Habana	161	22	8,2	7,7	70099
56188	Harmonia Birra	173	27,5	18,6	6,7	56154
56189	Harmonia Birra	173	38,5	20,2	7,3	70102
1013165	Harmonia Birra	173	58	21,3	8,4	66146
43488	Helsinki	165	27	9	8,9	66140
43489	Helsinki	165	32	14,3	7,7	66114
68561	Honey	165	26	9	8,5	66141
1763	Islande	169	29	14,5	6,3	66114
1767	Islande	169	30	9,3	7,9	66140
31688	Islande	169	20	8,4	7	56150
31689	Islande	169	22	13,1	5,8	66122
40108	Islande	169	17	12,5	5,2	66122
51094	Islande	169	31	16,6	6	66121
1764	Islande	169	22	15,2	5,3	66121
1765	Islande	169	16	10	5,6	66122
31687	Islande	169	33	15,7	6,3	56153
51117	Islande	169	10	8,7	5,1	66123
65371	Lima	156	38	11	8,8	66144
65372	Lima	156	35	8	9,4	70093
1011430	Lima	156	40	13,6	7,6	70101
1008185	Lineal	147	45	21,5	9,3	70096
1011419	Linely	164	45	17,5	7	56154
1011421	Linely	164	33	15,7	6,3	56153
1011432	Linely	164	22	13,1	5,8	66122
1011423	Linely	164	38	9,6	8,9	66139
1011422	Linely	164	20	8,4	7	56150
1011454	Log	161	16	7,8	6,28	56150
1011453	Log	161	22	7,8	6,35	56150
1012607	Lounge	165	40	10,7	8,9	70094
1793	Lyon	161	20	8,7	7,1	56150
1794	Lyon	161	16	7,9	6,6	56150
1011651	Macaron	154	40	10,4	8,5	66140

Code Verre	PRODUIT	Page catalogue	Cont (cl)	Haut (cm)	Diam (cm)	Code Casier
1011647	Macassar	163	36	12,95	8,4	66144
1011648	Macassar	163	28	12	7,83	66144
1011649	Macassar	163	38	10,45	9,9	66139
1011650	Macassar	172	6	7,85	4,9	66123
1000541	Malea	156	35	12,6	7,6	70100
1000578	Malea	156	30	10,5	7,5	70100
1013049	Martiques	169	16	15,1	6,9	66114
65390	Michelangelo	154	31	14,6	6,3	66114
65391	Michelangelo	154	34,5	10,9	8	66140
1013214	Mix and co	163	35	9,8	8,7	70094
71202	New Kalix	156	40	13	7,5	70100
71203	New Kalix	156	30	8,5	8,2	66141
1011447	New york	168	35	14,3	7,4	70101
1013248	New york	168	40	15,6	7,8	66142
50144	Nonic	173	28	11,5	7,3	70100
57109	Nonic	173	57	15,2	8,7	66142
31707	Norvège	161	20	8,8	7,2	56150
31708	Norvège	161	16	8,2	6,5	56150
1007479	Officina 1825	156	30	12,3	7,9	70100
1013330	Officina 1825	156	30	8,7	8,3	66141
63135	Open Up	154	38	9,4	9,3	70093
63529	Open Up Spirit	172	31	8,6	9,9	66134
68471	Open Up	154	35	11,8	7,7	70100
70331	Open Up Arabesque	154	38	9,4	9,3	66139
70446	Open Up Arabesque	154	35	11,8	7,7	70100
1007407	Ouessant	155	29	9,5	8	66140
1007408	Ouessant	155	45	14,7	8,1	66142
55755	Oxygen	161	16	8	6,8	56150
1007406	Perigord	173	38	16,8	8	66143
69319	Picardie	161	22	8,4	8,1	66141
69318	Picardie	161	16	7,8	7,5	66141
1013216	Picardie	161	9	6,7	6,5	56150
1011238	Picardie	161	25	9	8,5	66141
1011239	Picardie	161	36	12,5	8,8	70094
1005712	Primarific	159	35	10,2	8,1	66140
1005713	Primarific	159	35	10,2	8,1	66140
1005714	Primarific	159	35	10,2	8,1	66140
1011412	Primarific	159	36	10,2	8,1	66140
1011413	Primarific	159	36	10,2	8,1	66140
1011414	Primarific	159	36	10,2	8,1	66140
68463	Primary	155	35	10,2	8,1	66140
68464	Primary	155	44	11	8,7	66140
62405	Princesa	156	17,5	8,5	6,4	56150
62409	Prysm	169	27	8,9	9,4	70093
68207	Quartz	165	30	15,6	6,7	66121
68265	Quartz	165	25	9,5	8,5	66140
1011611	Rendez vous	163	36	12,95	8,35	66144
1011613	Rendez vous	163	28	12,05	7,75	70100
1011612	Rendez vous	163	32	9,55	8,9	66140
1006604	Reveal Up	154	40	23	9,1	70097
1006605	Reveal Up	156	30	11,07	9,7	70094
1006606	Reveal Up	134	30	9,1	8,4	66141
1000385	Rock Bar	160	27	8,4	9,2	70093
1000386	Rock Bar	160	27	8,4	9,2	70093
1000389	Rock Bar	160	27	8,4	9,2	70093
53594	Salto	156	35	12,1	7,6	70100
53595	Salto	156	32	8,4	9	70093
55746	Salto	159	32	8,4	9	70093
55747	Salto	159	35	12,1	7,6	70100
1005719	Salto Color Studio	159	32	8,3	8,9	70093
1005721	Salto Color Studio	159	32	8,3	8,9	70093
1005724	Salto Color Studio	159	32	8,3	8,9	70093
1005725	Salto Color Studio	159	35	12,1	7,6	70100
54318	Sambaya	170	40	13,2	9,4	70094
1770	Satellite	165	28	13,3	6,2	66114
1771	Satellite	165	25	9,1	7,4	66144
31703	Scotch	169	25	12,3	6,2	66122
43480	Scotch	169	21	10,8	6,15	66122
57110	Shetland	169	22	12,3	7,3	70100
57500	Shetland	169	25	8,8	9	70093
1000527	Stack Up	168	40	14,3	8,3	66142
1000528	Stack Up	168	35	14	7,8	70101
1000529	Stack Up	168	29	11,9	7,6	70100
1000530	Stack Up	168	32	9,2	9,2	66139
1001449	Stack Up	168	21	8	8,3	66141
1002654	Stack Up	168	26	9,2	8,5	66140
43485	Stockholm	169	27	9	8,9	66140
43486	Stockholm	169	32	14,3	7,7	66114
1011385	Sublime	155	45	13,3	7,2	70101
1011386	Sublime	155	35	9,2	7,8	66140
1012710	Tiki Pineapple	166	48	14	7	70101
1013156	Tiki Rock	166	47,3	11,7	7	70100
1011645	Twin	157	27	9	8,5	66140
1011644	Twin	157	27	9	8,5	66140
1011646						

## CHARIOTS POUR CASIER



### Chariot porte-casiers

**TOURNUS**  
EQUIPEMENT

En acier inoxydable. Plateau inox amovible épaisseur 1,2 mm. Dimensions utiles 51 x 51 cm. Dossieret boulonné. Tube 25 x 25 mm. 4 roues pivotantes Ø 12,5 cm à chape polyamide dont 2 à frein. Pare-chocs annulaires.

Charge maxi 150 kg P.U.HT  
**60699** E L. 63 x l. 57 x H. 90 cm x 1 **286,00 €**  
 Dont Éco-participation 0,19 €

### Socle Camdolly

**CAMBRO**  
TRUSTED FOR GENERATIONS™

En polypropylène. Plastique extrêmement durable à l'épreuve de la déformation, des fissures, de la rouille et de la corrosion. 4 roues pivotantes haute résistance Ø 8,9 cm assurent une manoeuvre aisée sur tout type de revêtement.

Charge maxi 159 kg P.U.HT  
**50594** E L. 54,5 x l. 54,5 x H. 20,5 cm x 1 **178,00 €**  
 Dont Éco-participation 0,78 €

**1<sup>er</sup> PRIX**



### Socle rouleur pour casiers

En polypropylène. 4 roues pivotantes en polyuréthane. Poignée en inox amovible pour un rangement aisé.

**Socle rouleur sans poignée**  
 Charge maxi 150 kg P.U.HT  
**65131P** E L. 54 x l. 54 x H. 10 cm x 1 **135,00 €**

**Poignée seule pour socle rouleur**  
P.U.HT  
**65132P** E x 1 **81,00 €**

## MANUTENTION



### Chariot plateforme

**TOURNUS**  
EQUIPEMENT

En alliage d'aluminium. 4 roues Ø 16 cm : chape acier électrozingué recouvertes de caoutchouc : 2 fixes et 2 pivotantes.

Charge maxi 350 kg P.U.HT  
**42349** E L. 120 x l. 60 x H. 100 cm x 1 **766,00 €**  
 Dont Éco-participation 0,46 €

### Triple trolley

**Rubbermaid**  
Commercial Products

En polyéthylène. Roues caoutchouc.

Charge maxi 180 kg P.U.HT  
**48058** E L. 82,6 x l. 52 cm x 1 **195,00 €**  
 Dont Éco-participation 0,74 €

Résistant à la rouille, aux coups et aux égratignures.  
 Bords arrondis : préserve vos murs, portes... 4 roues larges pour une plus grande stabilité. 3 positions d'utilisation.  
 Plateau antidérapant.



### Diable

Bavette repliable. Ossature en tube d'acier mécano-soudée. Revêtement époxy. Poignées ergonomiques avec garde pour plus de sécurité. Roues Ø 20 cm à bandage caoutchouc, montées sur roulements à rouleaux. Hauteur tablier 90 cm.

Charge maxi 250 kg P.U.HT  
**50707P** L. 42 x l. 32 x H. 128 cm x 1 **188,00 €**

**nouveau !**



### Marche-pied pliable

**Rubbermaid**  
Commercial Products

Supporte des températures allant de 0°C à +50°C.  
 Résistant à 150 kg.

**Marche-pied 2 marches**  
**1013303P** L. 48,6 x l. 17,2 x H. 63 cm x 1 **60,00 €**



Bacs disponibles en rouge, bleu, vert et jaune. Nous consulter



Bac



Grille



Aide à la gestion de la traçabilité



## Bac plat emboîtable

En polyéthylène haute densité. Légers, résistants, supportant la surgélation. Emboîtables à vide, gerbables avec couvercles. De -40°C / +90°C.

10 L - Dim : L. 54 x l. 38,8 x H. 8 cm			
<b>4265</b>	Bac	x 1	<b>P.U.HT 12,30 €</b>
<b>51112</b>	Grille	x 10	<b>3,70 €</b>
8 L - Dim : L. 48,5 x l. 33,5 x H. 7,5 cm			
<b>4264P</b>	Bac	x 1	<b>P.U.HT 12,40 €</b>
<b>38084P</b>	Grille	x 1	<b>3,70 €</b>
<b>50611P</b>	Bac avec couvercle	x 5	<b>18,25 €</b>
5 L - Dim : L. 43,7 x l. 29,5 x H. 7,5 cm			
<b>4263P</b>	Bac	x 1	<b>P.U.HT 9,90 €</b>
<b>38083P</b>	Grille	x 1	<b>3,50 €</b>
<b>50610P</b>	Bac avec couvercle	x 5	<b>15,25 €</b>
3 L - Dim : L. 34,7 x l. 23 x H. 7 cm			
<b>4262P</b>	Bac	x 1	<b>P.U.HT 6,40 €</b>
<b>38082P</b>	Grille	x 1	<b>2,80 €</b>
<b>50609P</b>	Bac avec couvercle	x 5	<b>12,10 €</b>
2 L - Dim : L. 30 x l. 20,5 x H. 6,5 cm			
<b>38575</b>	Bac	x 1	<b>P.U.HT 3,20 €</b>
<b>38576</b>	Grille	x 10	<b>1,70 €</b>

## Caisse ajourée avec identification



En polyéthylène haute densité. Empilable et emboîtable par rotation d'un demi-tour. Ajourements importants qui minimisent le temps de descente en température et facilitent le nettoyage. De -40°C / +90°C.

37 L - Dim : L. 60,2 x l. 40,5 x H. 19,7 cm			
<b>68627P</b>	Blanc	x 1	<b>P.U.HT 21,00 €</b>
27 L - Dim : L. 60,2 x l. 40,1 x H. 14,6 cm			
<b>1001274</b>	E Vert	x 1	<b>P.U.HT 23,00 €</b>
<b>1001273</b>	E Jaune	x 1	<b>23,00 €</b>
<b>1001275</b>	E Rouge	x 1	<b>23,00 €</b>
<b>68626P</b>	E Blanc	x 1	<b>20,25 €</b>
<b>1001272P</b>	E Bleu	x 1	<b>23,00 €</b>

## Caisse ajourée

Empilable et emboîtable par rotation d'un demi-tour. Dim : L. 60 x l. 40 cm. De -40°C / +90°C

Caisse ajourée			
<b>1013327P</b>	26 L - H. 14,7 cm - Bleu / bleu	x 1	<b>P.U.HT 24,50 €</b>
<b>1013328P</b>	27 L - H. 15,3 cm - Bleu / vert	x 1	<b>25,75 €</b>
<b>1013329P</b>	35 L - H. 19,1 cm - Beige / rouge	x 1	<b>28,75 €</b>

## Caisse ajourée gerbable

En polyéthylène haute densité. Plage d'utilisation allant de -40°C à +90°C. Dim : L. 60 x l. 40 cm.

Blanc			
<b>45020P</b>	E 15 L - H. 9 cm	x 1	<b>P.U.HT 13,50 €</b>
<b>45021P</b>	E 25 L - H. 13,5 cm	x 2	<b>20,75 €</b>
<b>45022P</b>	40 L - H. 20 cm	x 1	<b>28,25 €</b>
<b>50064P</b>	60 L - H. 30 cm	x 1	<b>31,50 €</b>
Gris			
<b>50063P</b>	E 40 L - H. 20 cm	x 1	<b>P.U.HT 25,50 €</b>
<b>50614P</b>	E 60 L - H. 30 cm	x 1	<b>28,50 €</b>

## Caisse à viennoiseries

En polyéthylène haute densité. Fond et parois ajourés. Empilable et emboîtable.

28 L - Dim : L. 60 x l. 38 x H. 15,5 cm			
<b>1011600P</b>	Beige	x 1	<b>P.U.HT 12,80 €</b>



Effet biocide

**Bac gerbable anti-bactérien Gilactiv®****Gilac**  
PROFESSIONNEL 

En polyéthylène haute densité additivée. Activité biocide du bac démontrée sur les souches proposées dans le règlement européen 073/2005/ec, par le ctcpa. Activité garantie sur la durée de vie du produit (supérieure ou égale à 2 ans - efficacité non altérée par le passage en lave-vaisselle à condition d'essuyer le bac après lavage). Design sans zone de rétention, grande résistance mécanique et très bonne tenue à la température -40°C et +90°C. Bac avec couvercle. Gerbable et empilable.

12 L - Dim : L. 40,5 x l. 30 x H. 18 cm			P.U.HT
65241	Rouge	x 1	40,25 €
65242	Bleu	x 1	40,25 €
65243	Vert	x 1	40,25 €
15 L - Dim : L. 40,5 x l. 30 x H. 22,8 cm			P.U.HT
65246	Rouge	x 1	46,75 €
65245	Bleu	x 1	46,75 €
65244	Vert	x 1	46,75 €
25 L - Dim : L. 60 x l. 40 x H. 18,3 cm			P.U.HT
65248	E Rouge	x 1	75,00 €
65247	E Bleu	x 1	75,00 €
65249	E Vert	x 1	75,00 €
35 L - Dim : L. 60 x l. 40 x H. 23 cm			P.U.HT
65251	Rouge	x 1	81,50 €
65250	Bleu	x 1	81,50 €
65252	Vert	x 1	81,50 €
55 L - Dim : L. 60 x l. 40 x H. 33,4 cm			P.U.HT
65254	Rouge	x 1	97,50 €
65253	Bleu	x 1	97,50 €
65255	Vert	x 1	97,50 €

Aide à la gestion de la traçabilité

**Bac gerbable****Gilac**  
PROFESSIONNEL 

En PEHD ( Polyéthylène Haute Densité ). Avec une identification des contenus simplifiée par un code couleur et une cartouche spécifique, cette gamme de bacs permet d'assurer une traçabilité optimale de vos préparations, notamment dans le cadre du déploiement d'une démarche HACCP. Bac avec couvercle.

35 L - Dim : L. 60 x l. 40 x H. 23 cm			P.U.HT
50057	Rouge	x 1	42,50 €
50058	Vert	x 1	42,50 €
50055	Bleu	x 1	42,50 €
55 L - Dim : L. 60 x l. 40 x H. 33,4 cm			P.U.HT
50061	E Rouge	x 1	53,50 €
50062	E Vert	x 1	53,50 €
50059	E Bleu	x 1	53,50 €
50060	E Jaune	x 1	53,50 €

Existe en jaune et blanc, nous consulter

**1<sup>er</sup> PRIX**

Existe en gris, nous consulter

**Bac gerbable blanc****Gilac**  
PROFESSIONNEL

En polyéthylène haute densité. Très résistant. Facile à nettoyer. Aucune zone de rétention. Gerbable avec ou sans couvercle. Température d'utilisation - 40°C / + 90°C.

			P.U.HT
4253	12 L - L. 40 x l. 30 x H. 16 cm	x 1	12,60 €
4254P	E 15 L - L. 40 x l. 30 x H. 21,5 cm	x 1	16,00 €
41739P	E Couvercle pour 12 L et 15 L	x 1	9,70 €
4255P	E 25 L - L. 60 x l. 40 x H. 16,5 cm	x 1	23,00 €
4257P	E 35 L - L. 60 x l. 40 x H. 21,7 cm	x 1	25,00 €
4259P	E 55 L - L. 60 x l. 40 x H. 31,5 cm	x 1	32,00 €
4256P	E Couvercle pour 25, 35 et 55 L	x 1	15,75 €

## SPÉCIAL TRAITEUR



### Bac pour assiettes

En polypropylène bleu. Bac avec couvercle intégré facilitant le transport et le stockage de vaisselle et d'autres accessoires de services. Emboîtable à vide et gerbable pleine.

			P.U. HT
<b>1001345P</b>	55 L - L. 60 x l. 40 x H. 30 cm	x 1	<b>65,50 €</b>
<b>1001346P</b>	25 L - L. 40 x l. 30 x H. 30 cm	x 1	<b>32,75 €</b>



### Bac pour grandes assiettes

En polyéthylène haute densité. Bleu. Bac avec couvercle facilitant le transport et le stockage de vaisselle et d'autres accessoires de services. Emboîtable à vide et gerbable pleine.

			P.U. HT
<b>27 L</b>			
<b>1001271P</b>	L. 40 x l. 30 x H. 32 cm	x 1	<b>38,50 €</b>



### Caisse à vaisselle

En polyéthylène haute densité. Fond renforcé. Blanc.

			P.U. HT
<b>32 L</b>			
<b>43028P</b>	L. 50 x l. 30 x H. 30 cm	x 1	<b>24,75 €</b>

**Gilac**  
PROFESSIONNEL



## MANNE À PAIN

### Manne à pain

En polyéthylène haute densité. Contenant spécialisé pour le stockage et le transport de vos baguettes ou pains. Ces mannes à pains s'empilent, se gerbent facilement chargées et s'utilisent avec des socles rouleurs pour simplifier leur manutention. Leur ajourage permet de conserver la qualité et la fraîcheur des produits.

			P.U. HT
<b>150 L - Poids 4,84 kg</b>			
<b>55569</b>	L. 66 x l. 45,8 x H. 67,2 cm	x 1	<b>81,50 €</b>
<b>180 L - Poids 5,4 kg</b>			
<b>55570</b>	L. 65,5 x l. 45,5 x H. 85,5 cm	x 1	<b>99,00 €</b>

**Gilac**  
PROFESSIONNEL



## SOCLES POUR BACS ET CAISSES

### Socle rouleur

En ABS. Très grande maniabilité, excellente stabilité, très bonne résistance à la charge et au franchissement de seuils. Adapté à l'ensemble des bacs et caisses 60 x 40 cm et 40 x 30 cm.

			P.U. HT
<b>Socle rouleur gris 4 roues pivotantes.</b>			
Charge maxi 250 kg			
<b>1001270P</b>	E L. 61,3 x l. 41,4 x H. 17,2 cm	x 1	<b>63,50 €</b>

### Socle rouleur gris 6 roues fixes.

La conception exclusive, basée sur 6 roues fixes, dont 2 roues centrales décalées, permet de s'affranchir des contraintes mécaniques liées au franchissement des seuils.

			P.U. HT
Charge maxi 250 kg			
<b>68624P</b>	E L. 61,3 x l. 41,4 x H. 13,5 cm	x 1	<b>64,00 €</b>

**Gilac**  
PROFESSIONNEL



Facilite le franchissement de seuils



### Timon

En inox. Facilite la manipulation des socles rouleurs.

			P.U. HT
<b>1007726</b>	E L. 9,2 x H. 92,5 cm	x 1	<b>86,50 €</b>

**Gilac**  
PROFESSIONNEL

## Cuvette

En PEBD. Durabilité, facilité de nettoyage, avec poignées pour faciliter la préhension. Répond aux exigences de l'industrie agroalimentaire, Résistante de -15°C à +60°C. Emboîtable.

**Gilac**  
PROFESSIONNEL



Blanc  
**39594** E Ø 43 x H. 17,5 cm - 14 L

**P.U.HT**  
x 1 **11,20 €**

## Seau hermétique emboîtable et gerbable

En polyéthylène haute densité. Seau carré avec couvercle hermétique et bec verseur. Simplifie le stockage du contenu liquide en chambre froide. Empilable. Étiquette d'identification simplifiant la gestion de la traçabilité.

**Gilac**  
PROFESSIONNEL **A.C.C.P.**



Autres coloris, nous consulter



A



B

Blanc  
A **68632** E Dim ext L. 32,9 x l. 31 x H. 19,7 cm - 8 L  
Dim int L. 19,5 x l. 19,5 x H. 15,5 cm

**P.U.HT**  
x 1 **19,25 €**

B **68633** E Dim ext L. 32,9 x l. 31 x H. 28 cm - 12 L  
Dim int L. 16,8 x l. 17,1 x H. 24,6 cm

**P.U.HT**  
x 1 **23,00 €**

## Bac de manutention

En polyéthylène basse densité. Solution de stockage, de préparation et de transport de contenu alimentaire. Température d'utilisation de -40°C à +90°C.

**Gilac**  
PROFESSIONNEL **A.C.C.P.**



Autres coloris, nous consulter



Bac de manutention rond  
**1013152P** Ø 67 x H. 48,5 cm - 75 L

**P.U.HT**  
x 1 **55,00 €**

Couvercle clipsable  
**1011601** Ø 61 cm

**P.U.HT**  
x 1 **16,25 €**

## Bac à ingrédients

En PEHD. Superposable. De -40°C à +90°C.

**Gilac**  
PROFESSIONNEL **A.C.C.P.**



Autres coloris, nous consulter



Blanc  
**1007727** L. 42,5 x l. 38,5 x H. 28 cm

**P.U.HT**  
x 1 **24,25 €**



## Bac à ingrédients

**Rubbermaid**  
Commercial Products

Déplacement facile : châssis mobile et amovible. Blocage du bac par rotation sur le socle. Très grande stabilité. Maniement aisé : larges poignées intégrées. Nettoyage parfait : conception sans joints, surface lisse et angles arrondis.

Bac à ingrédients rond  
**36471P** E Ø 49,5 x H. 58,1 cm  
76 L

**P.U.HT**  
x 1 **44,25 €**

Couvercle rond  
**36473P** E Ø 50,5 x H. 3,2 cm

**P.U.HT**  
x 1 **12,10 €**

Socle rouleur rond noir  
**38526P** E Ø 46 x H. 16,8 cm - 5 roues  
Charge maxi 135 kg

**P.U.HT**  
x 1 **83,00 €**



En polyéthylène. La forme carrée permet de stocker jusqu'à 14% de plus que les formes rondes dans le même espace.

Bac à ingrédients carré  
**1007599P** E L. 54,6 x l. 54,6 x H. 57,2 cm  
106 L

**P.U.HT**  
x 1 **56,00 €**

Couvercle carré clipsable  
**1007600P** E L. 55,9 x l. 55,9 x H. 5,1 cm

**P.U.HT**  
x 1 **17,25 €**

Socle rouleur carré noir  
**1007601P** E L. 43,8 x l. 43,8 x H. 15,9 cm  
Charge maxi 113,4 kg

**P.U.HT**  
x 1 **64,50 €**



## Bac à ingrédients

**Gilac**  
PROFESSIONNEL

En polypropylène. Couvercle transparent pour une meilleure visibilité, tient seul en position ouverte pour faciliter son utilisation. Ce bac se glisse aisément sous le plan de travail. De -20°C à +90°C. 4 roues.

Blanc

**1011147** E 100 L - L. 71 x l. 41 x H. 71 cm

x 1

**P.U.HT**  
**208,00 €**



## Camshelving

**CAMBRO**  
TRUSTED FOR GENERATIONS™

Utilisation en chambre froide, zone de réception ou de préconditionnement. En polymère monobloc, haute résistance, facile à nettoyer. Grande stabilité grâce aux étriers de maintien qui assemblent les palettes entre elles. Hauteur 30 cm pour maintien des produits au-dessus du sol et éviter toute contamination.

Poids 680 kg

**51534** L. 91,5 x l. 53,3 x H. 30 cm

x 1

**P.U.HT**  
**299,00 €**

Poids 1360 kg

**51533** L. 122 x l. 53,3 x H. 30 cm

x 1

**P.U.HT**  
**342,00 €**

Etrier pour maintien entre 2 palettes

**59690**

x 6

**P.U.HT**  
**3,70 €**



## Palette

**Gilac**  
PROFESSIONNEL

En polypropylène. Charge statique : 500 kg. Charge dynamique : 250 kg. Palette légère : 4,5 kg.

Poids 500 kg

**56067** E L. 120 x l. 80 x H. 14 cm

x 1

**P.U.HT**  
**44,00 €**

## Caillebotis

**Gilac** **H.A.C.C.P.**  
PROFESSIONNEL

Indispensable à l'aménagement des zones froides ou humides. La solution modulaire, évolutive, durable, simple à mettre en oeuvre, permettant une identification simplifiée et le déploiement d'une démarche HACCP dans des structures disposant de zones de stockage spécialisées. Isolant et antidérapant.

Facile à nettoyer : jet d'eau, nettoyeur haute pression, machine. Très simple à installer. Grande résistance à la charge.

Blanc

**42219P** E L. 50 x l. 50 x H. 2,2 cm.

x 1

**P.U.HT**  
**16,50 €**



Différents coloris,  
nous consulter

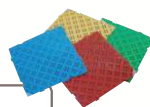

Lavable à la douchette  
basse pression  
Usage intensif



100 % inox !



Lavable à la douchette  
haute pression  
Travail en zone froide  
Finition semi-quantanium  
antidérapant  
Extracteur de lame SBR



## Trancheur Gravinox 350

**Dadaux**  
TECHNOLOGIES

GARANTIE  
1 an



Notre gamme de trancheurs à jambon «MAJOR SLICE» est unique sur le marché. Robuste et précis, il permet une coupe parfaite grâce à sa fiabilité de fonctionnement. Sa conception entièrement inox et son design aéré lui garantissent une facilité de nettoyage et une hygiène parfaite.

	Courroie
Lavable douchette basse pression	oui
Travail zone froide	oui
Alimentation	220 V
Puissance	270 W
Ø couteau	35 cm
Épaisseur de coupe	0 - 2,5 cm
Capacité de coupe	carré 28 x 19 cm / rond Ø 25 cm
Dimensions (L x p x H)	67,8 x 53,7 x 53,5 cm
Poids	17 kg
Référence	<b>1011034</b>
P.U H.T	<b>2 259,00 €</b>

## Trancheur Gravinox 300

**Dadaux**  
TECHNOLOGIES

GARANTIE  
1 an



Notre gamme de trancheurs à jambon «MAJOR SLICE» est unique sur le marché. Robuste et précis, il permet une coupe parfaite grâce à sa fiabilité de fonctionnement. Sa conception entièrement inox et son design aéré lui garantissent une facilité de nettoyage et une hygiène parfaite.

	Courroie
Lavable douchette basse pression	oui
Travail zone froide	oui
Alimentation	220 V
Puissance	200 W
Ø couteau	30 cm
Épaisseur de coupe	0 - 2,5 cm
Capacité de coupe	carré 25 x 16 cm / rond Ø 20 cm
Dimensions (L x p x H)	66,1 x 52,4 x 58,4 cm
Poids	15 kg
Référence	<b>1007645</b>
P.U H.T	<b>1 770,00 €</b>

## Trancheur Amiral 300

**DELCOUPE**  
la préparation par excellence

GARANTIE  
1 an



Revêtement aluminium, finition semi-quantanium et extracteur de lame SBR. Étanche IP54. Boutons et carte électronique de commande étanches IP66.

	Pignon	Courroie
Lavable douchette basse pression	Oui	Oui
Travail zone froide	Oui	Oui
Alimentation	230 V	230 V
Puissance	250 W	250 W
Ø couteau	30 cm	30 cm
Épaisseur coupe	3 cm	3 cm
Capacité de coupe	30 x 20,5 cm	30 x 20,5 cm
Dimensions (L x p x H)	66 x 57 x 45 cm	66 x 57 x 45 cm
Poids	29 kg	29 kg
Référence	<b>1004313 E</b>	<b>1004310 E</b>
P.U H.T	<b>3 103,00 €</b>	<b>2 370,00 €</b>



Jusqu'à  
400 couverts



## Trancheur à courroie 300

Construction aluminium anodisé. Plateau produit basculant. Affûteur mobile hygiénique sur l'appareil. Encombrement réduit.



Courroie	
Lavable douchette basse pression	Non
Travail en zone froide	Oui
Alimentation	230 V
Puissance	180 W
Ø couteau	30 cm
Epaisseur coupe	1,3 cm
Capacité de coupe	25 x 19 cm
Dimensions (L x p x H)	55 x 49 x 40 cm
Poids	20 kg
Référence	<b>1004292P E</b>
P.U H.T	<b>1 309,00 €</b>

nouveau !



## Trancheur à courroie Éco

Coque en aluminium. Couteau incliné. Avec aiguiseur.



	250	300
Lavable douchette basse pression	Non	Non
Travail zone froide	Non	Non
Alimentation	230 V	230 V
Puissance	140 W	210 W
Ø couteau	25 cm	30 cm
Epaisseur coupe	1,5 cm	1,5 cm
Capacité de coupe	19,5 x 14 cm	23 x 17,5 cm
Dimensions (L x p x H)	43,5 x 51 x 38,5 cm	48 x 63 x 46,1 cm
Poids	14,75 kg	20,8 kg
Référence	<b>1013584P</b>	<b>1013585</b>
P.U H.T	<b>540,00 €</b>	<b>795,00 €</b>



## Housse pour trancheur

Résistantes et transparentes. Ep. 17 µ.

Carton de 250  
**1008684P** E L. 115 x H. 74 cm

x 1

P.U.HT  
**56,00 €**





## Hachoir réfrigéré

**Dadaux**  
TECHNOLOGIES

**GARANTIE 1 an**  

Corps réfrigéré. Avec reconstitueur de steak hâché. Entièrement inox 18/10 : carter corps, hélice, écrou, etc. Démontage du corps par simple déverrouillage de la poignée latérale. Froid : compresseur hermétique. Gaz R134a. Régulation par thermostat à affichage digital. Portionneur 6 calibres : 90-110-130-150-170-190 g. Arrêt automatique au poids demandé. Existe en version monophasé 230V, nous consulter.

### Double coupe Tri

<b>Caractéristiques</b>	Double coupe. Capacité de la trémie : 4L. Ø de sortie : 82 mm. Ø de la grille : 3 mm. Viande en vrac par simple ouverture de la porte montée sur glissières.
<b>Alimentation</b>	400 V
<b>Puissance</b>	1100 W
<b>Capacité</b>	300 kg/heure
<b>Dimensions (L x p x H)</b>	28,5 x 39,7 x 54,4 cm
<b>Poids</b>	60 kg
<b>Référence</b>	<b>1011036</b>
<b>P.U H.T</b>	<b>3 670,00 €</b>

### Double coupe Mono

<b>Caractéristiques</b>	Simple coupe / double coupe. Capacité de la trémie : 4L. Ø de sortie : 82 mm. Ø de la grille : 3 mm. Viande en vrac par simple ouverture de la porte montée sur glissières.
<b>Alimentation</b>	230 V
<b>Puissance</b>	1100 W
<b>Dimensions (L x p x H)</b>	28,5 x 39,7 x 54,4 cm
<b>Poids</b>	60 kg
<b>Référence</b>	<b>1013518</b>
<b>P.U H.T</b>	<b>3 470,00 €</b>



## TC12

 **GARANTIE 1 an** 

Tout inox. Poussoir plastique. Design de l'hélice en spirale, quasiment inbloquable et au fonctionnement régulier. Moteur avec ventilateur de refroidissement et protection contre les surcharges. Fonctionne en marche arrière. Bouton reset. Taille compacte.

### TC12 / Simple coupe

<b>Caractéristiques</b>	Simple coupe. Livré avec 2 grilles de 4,6 et 8 mm. . Idéal pour les petites préparations d'appoints (tartares ...)
<b>Alimentation</b>	230 V
<b>Puissance</b>	550 W
<b>Capacité</b>	120 kg/heure
<b>Dimensions (L x p x H)</b>	45,5 x 32 x 48,5 cm
<b>Poids</b>	32 kg
<b>Référence</b>	<b>1001337P</b>
<b>P.U H.T</b>	<b>755,00 €</b>



## FUMOIRS



### Qu'est ce que le fumage ?

Les aliments sont soumis, de manière prolongée, à la fumée qui procure un effet antiseptique et améliore la conservation tout en rehaussant le goût.

Le fumage donne un goût boisé aux aliments.

Il convient de fumer plus particulièrement les viandes (steak, côtelette, filet mignon...), volailles (poulet, canard...), charcuteries (essentiellement jambon, lard, saucisse, saucisson, andouilles) et les poissons (saumons, truites, anguilles, maquereaux...).

Toutefois, on peut également l'appliquer à l'ail, pommes de terre, fromages, beurre... et tout autre aliment selon vos envies !

Le principe consiste à exposer les aliments à la fumée, à différentes températures, selon le résultat souhaité.



### Fumoir

de Buyer  INOX 18/10

Pour fumer à froid et à chaud. Livré en kit avec un thermomètre et un sachet de sciure. La sciure pour fumoir vous offre un délicat et léger arôme de fumée. Etuvée et dépoussiérée. Garantie sans produit chimique. Granulométrie : 0,5 à 1,0 mm. Humidité 8 à 12 %. Conforme aux normes DIN ISO 9001.

Fumoir

**70109** L. 27 x l. 27 x H. 30 cm



x 1

P.U.HT

**178,00 €**

Sciure de hêtre spéciale fumoir

**70127P** 500 g



x 10

P.U.HT

**11,90 €**

nouveau !



### Pistolet à fumer

Appareil portable pour fumer à froid toutes vos préparations : viandes, poissons, fruits de mer, fruits, légumes, salades, boissons et cocktails, sauces et vinaigrettes, salades, soupes, épices, desserts...

GARANTIE 1 an 

Pistolet à fumer

**1013005P** L. 8 x P. 13 x H. 17 cm



x 1

P.U.HT

**210,00 €**

## TRANCHEUR À PAIN



Socle en option

### Trancheur à pain

robot coupe  GARANTIE 1 an 

Appareil tout inox. Moteur asynchrone. Plateau réglable pour déterminer l'épaisseur des tranches de 8 à 80 mm d'épaisseur. Lame très facilement démontable. Système exclusif de sécurité infrarouge. Livré avec ramasse-miettes.

En option : socle inox mobile.

#### TP 180

Utile	Bac pour la réception des miettes
Alimentation	230 V
Puissance	350 W
Rendement	180 à 360 tranches de pain à la mn avec une épaisseur de 8 à 80 mm
Dimensions (L x p x H)	33,5 x 38,5 x H. 92 cm
Poids	28,2 kg
Référence	<b>63496 E</b>
P.U.HT	<b>2 050,00 €</b>





20 à 300 couverts  
 Pour la réalisation des :

- émincés
- ondulés
- rapés
- bâtonnets
- frites
- macédoines
- brunoises\*
- gaufrettes\*

\* pour le CL50 Gourmet



### CL 50 Gourmet

robot coupe GARANTIE 1 an CE Made in France

7 coupes spéciales : 3 brunoises et 4 gaufrettes. Le couvercle du CL 50 Gourmet est équipé d'une goulotte demi-lune pour la coupe de produits fragiles et volumineux. La goulotte cylindrique d'un diamètre de 69 mm a été conçue pour la coupe des légumes longs. Un insert de maintien breveté permet de guider le légume ou le fruit pendant les coupes gaufrettes et brunoises éjectées dans un bac de réception. Bloc moteur en inox. Sécurité magnétique sur le poussoir et le couvercle. Frein moteur. Livré sans disque.

CL 50 Gourmet	
Vitesse	375 trs/min
Voltage	Mono 230 V
Puissance	550 W
Débit horaire	250 kg/h
Dimensions (L x P x H)	37,6 x 30,9 x 58,1 cm
Poids	21,5 kg
Référence	<b>61350</b>
P.U H.T	<b>1 935,00 €</b>

**Disque brunoise**

Référence	Dimensions	Quantité	P.U.HT
<b>61351</b>	L. 2 x l. 2 x H. 2 mm	x 1	<b>173,00 €</b>
<b>61352</b>	L. 3 x l. 3 x H. 3 mm	x 1	<b>173,00 €</b>
<b>61353</b>	L. 4 x l. 4 x H. 4 mm	x 1	<b>173,00 €</b>

**Disque gaufrette**

Référence	Dimensions	Quantité	P.U.HT
<b>61354</b>	Ø 4 mm	x 1	<b>151,00 €</b>
<b>61355</b>	Ø 6 mm	x 1	<b>151,00 €</b>

Disque gaufrette 2 et 3 mm, nous consulter

### CL 50

robot coupe GARANTIE 1 an CE Made in France

Coupes spéciales : 9 macédoines et 3 frites. Ce coupe-légumes se compose de 2 goulottes : 1 grande goulotte (surface de 139 cm<sup>2</sup>) permettant la coupe de légumes volumineux tels que le chou et le céleri et 1 goulotte cylindrique (Ø 58 mm) permettant la coupe de légumes longs ou fragiles. Bloc moteur en polycarbonate. Sécurité magnétique sur le poussoir et le couvercle. Frein moteur. Livré sans disque.

CL 50	
Vitesse	375 trs/min
Voltage	Mono 230 V
Puissance	550 W
Débit horaire	250 kg /h
Dimensions (L x P x H)	35 x 32 x 59 cm
Poids	17,6 kg
Référence	<b>42338P</b> €
P.U H.T	<b>1 220,00 €</b>

#### Équipement spécial collectivité

Eminceurs 2 mm, 5 mm  
 Râpeurs 2 mm, 3 mm.  
 1 Kit macédoine (1 éminceur 10 mm + 1 grille 10 x 10 mm)  
 + 1 éminceur 14 mm + 1 grille 14 x 14 mm) + 1 porte-disque mural.

Référence	Quantité	P.U.HT
<b>42339</b> E	x 1	<b>770,00 €</b>

#### Équipement spécial CHR

Eminceurs 1 mm, 3 mm. Râpeur 2 mm. Bâtonnet 4 x 4 mm.  
 1 Kit macédoine (1 éminceur 10 mm + 1 grille 10 x 10 mm)  
 + 1 porte-disque mural.

Référence	Quantité	P.U.HT
<b>1005262</b>	x 1	<b>642,00 €</b>

### Robot Cook®

robot coupe GARANTIE 1 an CE Made in France

Cutter-Blender chauffant. Température de chauffe au degré près jusqu'à 140°C. Moteur asynchrone industriel. Système de retenue du couteau dans la cuve pour faciliter le vidage des liquides. Tous les accessoires passent au lave-vaisselle. 9 programmations.

Robot Cook®	
Utile	Couteau avec lames inox micro dentées. Bras racleur démontable. Couvercle anti-vapeur avec orifice.
Vitesse	4 vitesses : - variable 100 à 3500 tr/min - haute vitesse pulse turbo 4500 tr/min - vitesse de mélange R Mix 100 à - 500 tr/min - vitesse variable intermittente
Alimentation	230 V
Puissance	1800 W
Taille cuve/capacité liquide	3,7 L / 2,5 L
Dimensions (L x p x H)	33,8 x 22,6 x 52,2 cm
Poids	15 kg
Référence	<b>1001645</b>
P.U H.T	<b>2 485,00 €</b>



- Emulsionner
- Pulvériser
- Mixer
- Hacher
- Mélanger
- Pétrir
- A chaud ou à froid





Couteau lisse

Hacher gros



Couteau lisse

émulsionner



Couteau lisse

Mélanger



Couteau cranté

Pétrir



Couteau cranté

Broyer

Couteau denté :  
pour hacher fin  
et émulsionner.



4,5 L  
10 à 50 couverts



3,7 L  
10 à 30 couverts



3,7 L  
10 à 30 couverts



2,9 L  
10 à 20 couverts



## Cutter R

robot coupe® GARANTIE 1 an Made in France

Une gamme complète de cutters pour :

- une parfaite homogénéisation des produits travaillés : couteau lisse fond de cuve.
- une très grande finesse de coupe : commande à impulsions.
- un mélange optimal : couvercle de cuve permettant l'adjonction de liquide ou d'ingrédients en cours de préparation.
- broyer, pétrir, hacher.

Robuste : arbre moteur en inox en totale conformité avec les normes les plus strictes d'hygiène et de sécurité.

R4	
Vitesse	1500 et 3000 tr/min/pulse
Voltage	Tri 400 V
Puissance	900 W
Couteau inclus	Lisse *
Dimensions (L x P x H)	22,6 x 30,4 x 44 cm
Poids	17,6 kg
Référence	100138
P.U H.T	1 515,00 €

R3 3000	
Vitesse	3000 tr/min/pulse
Voltage	Mono 230 V
Puissance	650 W
Couteau inclus	Lisse *
Dimensions (L x P x H)	21 x 32 x 40 cm
Poids	13,1 kg
Référence	66432
P.U H.T	1 405,00 €

R3 1500	
Vitesse	1500 tr/min/pulse
Voltage	Mono 230 V
Puissance	650 W
Couteau inclus	Lisse *
Dimensions (L x P x H)	21 x 32 x 40 cm
Poids	11,2 kg
Référence	66431
P.U H.T	1 260,00 €

R2	
Vitesse	1500 tr/min/pulse
Voltage	Mono 230 V
Puissance	550 W
Couteau inclus	Lisse *
Dimensions (L x P x H)	20 x 28 x 35 cm
Poids	10,5 kg
Référence	66430
P.U H.T	965,00 €

\* Lame crantée et dentée en option



**Hacher gros****Mélanger****Hacher fin****Emulsionner****Pétrir****Broyer****Émincés****Rapés****Frites\*****Ondulés****Bâtonnets****Macédoine\***

\* pour le R502

5,5 L  
30 à 300 couverts4,5 L  
20 à 100 couverts3,7 L  
10 à 70 couverts2,9 L  
10 à 30 couverts**Combiné R**

robot coupe®

GARANTIE  
1 an

Robot multifonctions conçu pour réaliser hachage, émulsion, pétrissage, broyage ou encore des sauces en cutter et des émincés, coupes ondulées, râpés ou juliennés en coupe-légumes. Bloc moteur asynchrone. Commande à impulsions pour une meilleure précision de coupe.

Fonction cutter : couteau lisse livré\*.

Fonction coupe-légumes : composé de 2 goulottes (cylindrique + demi-lune, cylindrique et grande goulotte XL pour le R211 Ultra XL). Gamme complète de disques en inox disponible.

**R502**

Disque inclus	En option
Vitesse	750 et 1 500 tr/min/pulse
Puissance	1 000 W
Voltage	Tri 400 V
Dimensions (L x P x H)	38 x 35 x 66,5 cm
Poids	30 kg
Référence	<b>67780</b> €
P.U H.T	<b>2 420,00</b> €

**R401****R301 Ultra**

Disque inclus	En option	Râpeur 2 mm, éminceur 2 et 4 mm, bâtonnet 2x2 mm
Vitesse	1 500 tr/min/pulse	1 500 tr/min/pulse
Puissance	700 W	650 W
Voltage	Mono 230 V	Mono 230 V
Dimensions (L x P x H)	32 x 30,4 x 57 cm	32,5 x 30 x 55 cm
Poids	18,5 kg	15 kg
Référence	<b>55682</b>	<b>60698P</b> €
P.U H.T	<b>1 750,00</b> €	<b>1 590,00</b> €

**R211 Ultra XL**

Disques inclus	Éminceur 2 mm, 4, râpeur 2 mm, bâtonnet 2 x 2 mm	
Vitesse	1 500 tr/min/pulse	
Puissance	550 W	
Voltage	Mono 230 V	
Dimensions (L x P x H)	22 x 30 x 44,5 cm/72 cm (avec accessoires)	
Poids	9,5 kg	
Référence	<b>1001227</b> €	
P.U H.T	<b>1 167,00</b> €	

\* lame crantée et dentée en option



# DISQUES POUR COUPE-LÉGUMES ET COMBINÉ CUTTER / COUPE-LÉGUMES

Disque vendu à l'unité.



Gamme complète Robot Coupe disponible sur commande, nous consulter

Coupe	Taille	Ø 17,5 cm - CL20, CL40, R201, R211, R301, R301 ultra, R401, R402, R402 V.V		Ø 19 cm CL50/CL52/CL55/CL60 R502 U/ R652 V.V	
Émincés 	1 mm		1010702 49,00 €		1010703 103,00 €
	2 mm		1014123 49,00 €		1014129 103,00 €
	3 mm		1010704 49,00 €		1014130 103,00 €
	4 mm		1014124 49,00 €		1014131 103,00 €
	5 mm		1010705 49,00 €		1010707 103,00 €
	6 mm		1010706 49,00 €		1010708 103,00 €
	8 mm		-		1010709 103,00 €
	10 mm		-		1010710 103,00 €
Ondulés 	2 mm		1010711 49,00 €		1010712 128,00 €
	3 mm		-		1010713 128,00 €
	5 mm		-		1010714 128,00 €
Rapés 	1,5 mm		1010715 49,00 €		1014135 75,00 €
	3 mm		1010716 49,00 €		1014136 75,00 €
Bâtonnets 	2 x 2 mm		1014126 57,00 €		1010719 142,00 €
	3 x 3 mm		-		1010720 142,00 €
	4 x 4 mm		1010717 57,00 €		1010721 142,00 €
	2 x 10 mm (tagliatelles)		-		1010722 142,00 €
	6 x 6 mm		1010727 213,00 €		1014132 142,00 €
	8 x 8 mm		1010718 57,00 €		1014133 142,00 €
Macédoines 	10 x 10 mm		-		1010723 204,00 €
	20 x 20 mm		-		1010724 204,00 €
Frites** 	8 x 8 mm		1010725* 197,00 €		1010727 213,00 €
	10 x 10 mm		1010726* 197,00 €		1010728 213,00 €
Gaufrette* 	2 mm		-		1010729 151,00 €

\*\* Seulement R 402

## COUTEAUX

### Couteau lisse



Hachage gros/fin



Emulsion

### Couteau cranté



Broyage



Pâtisserie

### Couteau denté



Hachage d'herbes/épices



Coupe persil

## COUTEAUX POUR COUPE-LÉGUMES ET COMBINÉS CUTTER / COUPE-LÉGUMES



Coupe	R101XL - R201 XL R211XL - R2	R301 R301 Ultra - R3	R401 - R402	R502 - R5	R652 - R6
Couteaux lisses (Gros hachage / hachage fin, émulsion) 	1011245 80,00 €	1014153P 82,00 €	1011246 80,00 €	1011247 130,00 €	1011248 274,00 €
Couteaux crantés (spécial broyage-pâtisserie) 	1011249* 90,00 €	1014152 92,00 €	1011250 90,00 €	1011251 143,00 €	1011252 282,00 €
Couteaux dentés (spécial herbes, épices) 	1011253** 90,00 €	1011254 90,00 €	1011255 90,00 €	1011256 143,00 €	1011257 282,00 €

\* Non compatible avec R2

\*\* Non compatible avec R101 XL



Réunit en une seule machine, les qualités de 2 appareils :

Le cutter et le blender / mixer. Grande capacité liquide pour réaliser avec une plus grande facilité toutes les préparations à texture modifiée cuites et crues liquides ou semi-liquides.

Idéal pour les préparations hôpitaux, cliniques, établissements spécialisés, maisons de retraite...



### Entrée



7 L  
20 à 100 couverts



### Plat



5,5 L  
20 à 80 couverts



4,5 L  
10 à 50 couverts



### Dessert



3,7 L  
10 à 30 couverts



2,9 L  
1 à 15 couverts

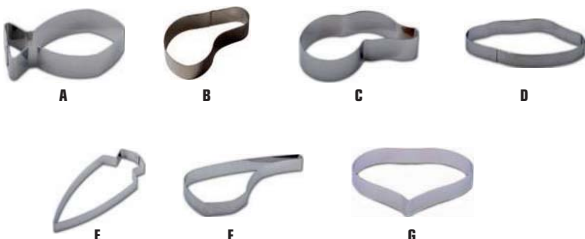

**Blixer®**

robot coupe® **GARANTIE 1 an**

#### Blixer® 6 V.V.

Vitesse	300 à 3000 tr/min/pulse
Voltage	Mono 230 V
Puissance	1500 W
Quantité travaillée	0,5 à 4,5 kg
Dimensions (L x P x H)	28 x 35 x 53,5 cm
Poids	26,3 kg
Référence	<b>1006670 E</b>
<b>P.U H.T</b>	<b>3 005,00 €</b>

#### Blixer® 5 V.V.

Vitesse	300 à 3000 tr/min/pulse
Voltage	Mono 230 V
Puissance	1400 W
Quantité travaillée	0,4 à 3,5 kg
Dimensions (L x P x H)	28 x 35 x 50 cm
Poids	25 kg
Référence	<b>63184 E</b>
<b>P.U H.T</b>	<b>2 480,00 €</b>

#### Blixer® 4

Vitesse	1500 et 3000 tr/min/pulse
Voltage	Tri 400 V
Puissance	1000 W
Quantité travaillée	0,4 à 3 kg
Dimensions (L x P x H)	24,2 x 30,4 x 44,4 cm
Poids	17,3 kg
Référence	<b>55684 E</b>
<b>P.U H.T</b>	<b>1 605,00 €</b>

#### Blixer® 3

Vitesse	3000 tr/min/pulse
Voltage	Mono 230 V
Puissance	750 W
Quantité travaillée	0,3 à 2 kg
Dimensions (L x P x H)	24,2 x 30,4 x 44,4 cm
Poids	13,2 kg
Référence	<b>63174</b>
<b>P.U H.T</b>	<b>1 490,00 €</b>

#### Blixer® 2

Vitesse	3000 tr/min/pulse
Voltage	Mono 230 V
Puissance	700 W
Quantité travaillée	Spécial monoportion - 0,2 à 1,5 kg
Dimensions (L x P x H)	21 x 28,1 x 38,9 cm
Poids	11,5 kg
Référence	<b>64293 E</b>
<b>P.U H.T</b>	<b>1 230,00 €</b>

## Cercles

Idéal pour présenter de façon attractive les préparations mixées. Spécialement adaptés pour les maisons de retraites.

**GOBEL**

Formes			<b>P.U.H.T</b>
<b>1002276</b>	A - Poisson 10 x 5 x 3 cm	x 1	<b>5,20 €</b>
<b>1002281</b>	B - Côte de porc 13 x 9 x 1,5 cm	x 1	<b>5,20 €</b>
<b>1002275</b>	C - Pilon de poulet 10 x 5 x 3 cm	x 1	<b>5,20 €</b>
<b>1002277</b>	D - Pomme de terre 13 x 8 x 5 cm	x 1	<b>5,20 €</b>
<b>1002278</b>	E - Carotte 14 x 5,5 x 1,5 cm	x 1	<b>5,20 €</b>
<b>1002280</b>	F - Côte d'agneau 14 x 4,5 x 1,5 cm	x 1	<b>5,20 €</b>
<b>1002279</b>	G - Navet 10,5 x 10 x 1,5 cm	x 1	<b>5,20 €</b>





## MIXERS LARGES

Spécial collectivités  
Traiteur  
Usage intensif

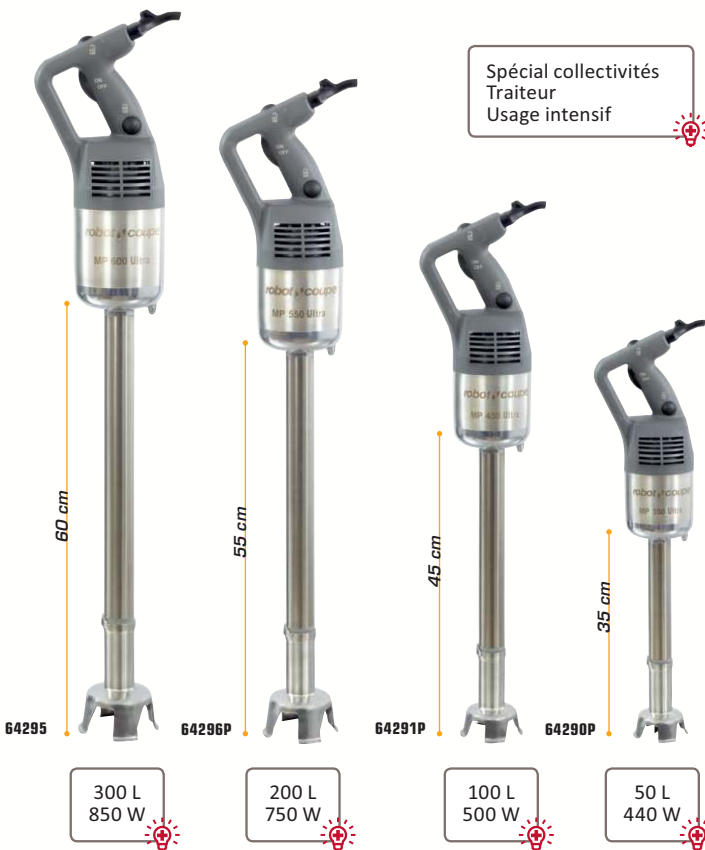

64295

64296P

64291P

64290P

300 L  
850 W200 L  
750 W100 L  
500 W50 L  
440 W

### Mixer large

robot *coupe*

GARANTIE  
1 an



Pied avec couteau démontable, équipé d'un système d'étanchéité à 3 niveaux.  
Livré avec un support mural inox.

	MP600 Ultra	MP550 Ultra	MP450 Ultra	MP350 Ultra
Litre	300 L	200 L	100 L	50 L
Longueur tube	60 cm	55 cm	45 cm	35 cm
Longueur totale	98 cm	94 cm	84 cm	74 cm
Vitesse	9500 trs/min	9500 trs/min	9500 trs/min	9500 trs/min
Puissance	850 W	750 W	500 W	440 W
Voltage	Mono 230 V	Mono 230 V	Mono 230 V	Mono 230 V
Poids	7,4 kg	6,6 kg	6,3 kg	6,2 kg
Référence	<b>64295</b>	<b>64296</b>	<b>64291 E</b>	<b>64290 E</b>
P.U.H.T	<b>940,00 €</b>	<b>742,00 €</b>	<b>472,00 €</b>	<b>426,00 €</b>

## COMBI MIXERS

Utiliser le fouet pour :

- Émulsionner
- Fouetter
- Mélanger
- Malaxer
- Égréner

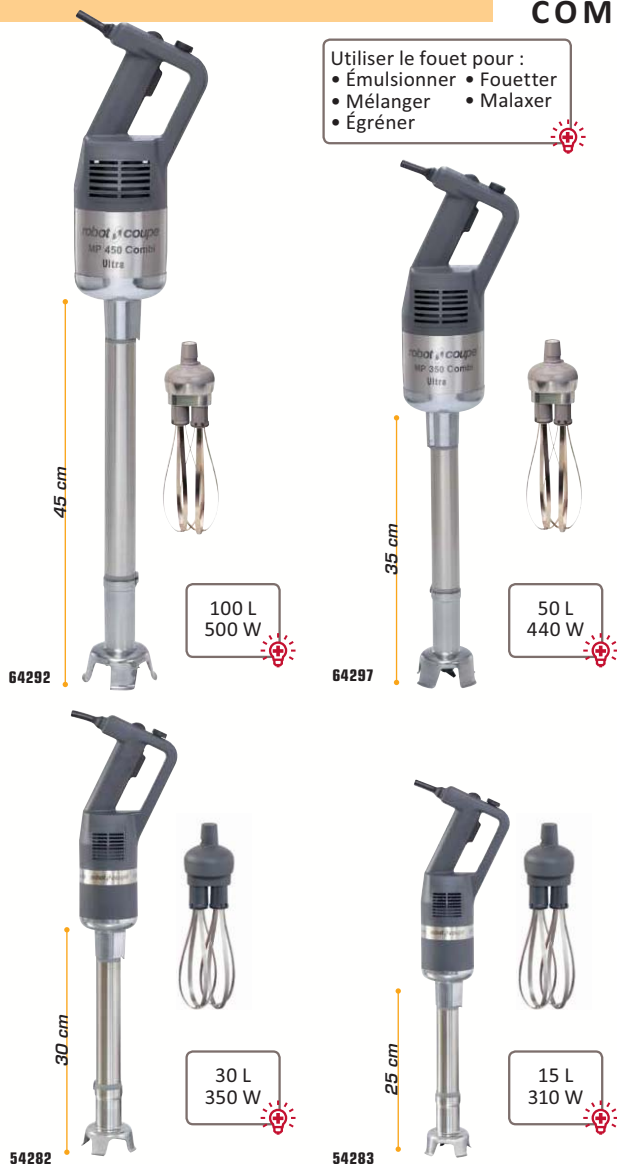

64292

64297

54282

54283

100 L  
500 W50 L  
440 W30 L  
350 W15 L  
310 W

### Combi-Mixer

robot *coupe*

GARANTIE  
1 an



Pied avec couteau démontable, équipé d'un système d'étanchéité à 3 niveaux.  
Livré avec un support mural inox.

#### Combi-mixer large + fouet

	Combi MP450 Ultra	Combi MP350 Ultra
Litre	100 L	50 L
Longueur tube	45 cm	35 cm
Longueur fouet	28 cm	28 cm
Long. totale tube	89 cm	79 cm
Long. totale fouet	84 cm	80,5 cm
Vitesse fouet	250 à 1500 trs/min	250 à 1500 trs/min
Vitesse Mixer	1500 à 9000 trs/min	1500 à 9000 trs/min
Puissance	500 W	440 W
Voltage	Mono 230 V	Mono 230 V
Poids	8,2 kg	7,9 kg
Référence	<b>64292 E</b>	<b>64297 E</b>
P.U.H.T	<b>717,00 €</b>	<b>668,00 €</b>

#### Combi-mixer compact + fouet

	Combi CMP 300	Combi CMP 250
Litre	30 L	15 L
Longueur tube	30 cm	25 cm
Longueur fouet	22 cm	22 cm
Longueur totale tube	70 cm	64 cm
Longueur totale fouet	61 cm	61 cm
Vitesse fouet	500 à 1800 trs/min	500 à 1800 trs/min
Vitesse Mixer	2300 à 9600 trs/min	2300 à 9600 trs/min
Puissance	350 W	310 W
Voltage	Mono 230 V	Mono 230 V
Poids	5,7 kg	5,6 kg
Référence	<b>54282</b>	<b>54283</b>
P.U.H.T	<b>576,00 €</b>	<b>545,00 €</b>



Spécial  
restauration60 L  
420 W

40 cm



## Mixer compact

robot coupe®

GARANTIE  
1 an

Pied avec couteau démontable, équipé d'un système d'étanchéité à 3 niveaux. Livré avec un support mural inox.

### CMP 400VV

Litre	60 L
Longueur tube	40 cm
Longueur totale	75 cm
Vitesse	2300 à 9600 tr/min
Puissance	400 W
Voltage	Mono 230 V
Poids	4,1 kg
Référence	<b>70152 E</b>
P.U H.T	<b>453,00 €</b>

Spécial petites  
préparations

24 cm

15 L  
290 W

## Mini-mixer

robot coupe®

GARANTIE  
1 an

Pied avec couteau démontable, équipé d'un système d'étanchéité à 3 niveaux. Livré avec un support mural inox.

### MP240VV

Litre	15 L
Longueur tube	24 cm
Longueur totale	53,5 cm
Vitesse	2 000 à 12 500 trs/min
Puissance	290 W
Voltage	Mono 230 V
Poids	2,5 kg
Référence	<b>66657</b>
P.U H.T	<b>317,00 €</b>

10 L  
270 W

19 cm



### MP190VV

Litre	10 L
Longueur tube	19 cm
Longueur totale	48,5 cm
Vitesse	2 000 à 12 500 trs/min
Puissance	270 W
Voltage	Mono 230 V
Poids	2,5 kg
Référence	<b>64283</b>
P.U H.T	<b>269,00 €</b>



16 cm

6 L  
220 W

### MP160VV

Litre	6 L
Longueur tube	16 cm
Longueur totale	45,5 cm
Vitesse	2 000 à 12 500 trs/min
Puissance	240 W
Voltage	Mono 230 V
Poids	2,4 kg
Référence	<b>64282</b>
P.U H.T	<b>222,00 €</b>

Emulsions  
Avec couteau  
spécial  
Aéromix

16,5 cm

240 W



### MICROMIX

Longueur tube	16,5 cm
Longueur totale	43 cm
Vitesse	1500 à 14000 trs/min
Puissance	220 W
Voltage	Mono 230 V
Poids	1,4 kg
Référence	<b>1007016P</b>
P.U H.T	<b>178,00 €</b>



Spécial petites préparations



Sans fil pour évoluer sans contraintes



1001298P

4 L  
220 W



1001295P

8 L  
250 W



1011494P

4 L  
200 W



GARANTIE 1 an



## Mixer MP

Pied démontable et cloche en acier inox pour une hygiène parfaite. Couteaux Ti-Métal, faciles à démonter. Ergonomique, robuste, silencieux. Pour la version sans fil, batterie Lithium-Ion (autonomie 30 mn) et chargeur.

	Mixer 160	Mixer 190	Mixer Air 160 Sans fil
Litre	1 à 4 L	1 à 8 L	1 à 4 L
Longueur tube	16 cm	19 cm	16 cm
Longueur totale	39,5 cm	42,5 cm	45 cm
Vitesse	0 à 13000 tr/min	0 à 13000 tr/min	0 à 10000 tr/min
Puissance	220 W	250 W	200 W
Voltage	230 V	230 V	Batterie 12 V
Référence	✓ 1001298P E	1001295P E	1011494P E
P.U.H.T	158,00 €	221,00 €	240,00 €



1 à 5 kg



## Presse purée

En inox.

1011507 L. 12,6 cm



x 1

P.U.H.T  
163,00 €



1 à 5 kg



## Fouet

En inox.

1011504 L. 18,5 cm



x 1

P.U.H.T  
104,00 €



1 à 4 kg



## Pied de blender

Vitesse en charge : 0 à 13 000 trs/ min. Broyez, concassez, mélangez, lissez ou émulsionnez à la perfection en quelques minutes seulement ! Pour mixers filaires.

1011499 1 à 4 kg - L. 16 cm



x 1

P.U.H.T  
112,00 €



## Bol cutter

En copolyester.

1011514 0,8L



x 1

P.U.H.T  
155,00 €





## Mixer MDH 2000 Plus

Puissance : 500 W.  
Voltage : 230 V.  
Vitesse : 3000 à 9500 tr/min.

A + C - Mixer avec pied démontable  
**49247** E L. totale 72 cm



GARANTIE 1 an



x 1 **P.U.HT**  
**563,00 €**

### Accessoires :

A - Bloc moteur  
**63178** E L. 12,2 x H. 35 cm

x 1 **P.U.HT**  
**372,00 €**

B - Fouet  
**63180** E L. 24,5 cm

x 1 **P.U.HT**  
**226,00 €**

C - Pied mixeur  
**63179** E L. 42 cm

x 1 **P.U.HT**  
**173,00 €**

D - Fouet mélangeur  
**63183** E L. 70 cm  
**63182** E L. 60 cm

x 1 **P.U.HT**  
**420,00 €**  
x 1 **402,00 €**

E - Pied mixeur pour blender master pour bloc moteur BM 2000 et MDH  
**1010283** L. 41 cm

x 1 **P.U.HT**  
**284,00 €**



## Mixer large



GARANTIE 1 an



	PMDH 250	MIXER PRO SMX 600DSC
Litre	40 L	75 à 200 L
Longueur tube	30 cm	60 cm
Longueur totale	64 cm	87 cm
Vitesse	9500 trs/min	9500 trs/min
Puissance	350 W	850 W
Voltage	230 V	Mono 230 V
Référence	<b>64334</b> E	<b>58353</b> E
P.U. H.T	<b>468,00 €</b>	<b>1 072,00 €</b>



## Combi-mixer

Mixer et fouet.



GARANTIE 1 an



	MF2000
Litre	40 à 100 L
Longueur tube	41 cm
Longueur fouet	24,5 cm
Longueur totale tube	75,3 cm
Vitesse fouet	300 à 900 trs/min
Vitesse Mixer	3000 à 9500 trs/min
Puissance	500 W
Voltage	Mono 230 V
Référence	<b>63177</b> E
P.U. H.T	<b>760,00 €</b>



5,5 L  
10 à 50 couverts



Livré avec  
kit pâtisserie



Cuve 6,9 L  
Pétrir  
Malaxer  
Mélanger  
Battre  
Fouetter



Livré avec  
kit pâtisserie



Cuve 4,83 L  
Pétrir  
Malaxer  
Mélanger  
Battre  
Fouetter



Hachoir à viande  
**31228P**

x 1

P.U.HT  
**88,00 €**



Fouet  
**56499P**

x 1

P.U.HT  
**41,25 €**



Kit 3 accessoires :  
- Hachoir à viande,  
- Passoire à fruits et légumes,  
- Tranchoir / râpe à cylindres.

**45101**

x 1

P.U.HT  
**209,00 €**

## DMix



Convient à toutes les opérations : pétrir, mélanger et fouetter. Corps en métal et une large base pour une complète stabilité. Cuve en acier inoxydable 18/10 (AISI 304) avec 2 poignées. Rotation du fouet jusqu'à 500 tr/mn. Ecran transparent amovible sans bisphénol-A (BPA) associé au monte et baisse de cuve.

### DMX5

Outils	Livré avec 3 outils : fouet, palette et crochet spirale
Variateur de vitesse	Electronique
Vitesse	40 à 240 tr/min
Alimentation	Mono 230 V
Puissance	500 W
Capacité de pétrissage (farine en détrempee)	1,5 kg
Dimensions (L x P x H)	31,2 x 41 x 43,4 cm
Poids	13 kg
Caractéristique	Avec prise d'accessoire type K (pour coupe-légumes, hachoir ..)
Référence	<b>1007360P</b>
P.U.H.T	<b>565,00 €</b>

## Heavy Duty



En zinc moulé sous pression. Stable, silencieux et résistant. Avec prise d'accessoires.

### HEAVY DUTY

Outils	Bol inox avec poignée. Livré avec kit de pâtisserie (crochet, batteur et fouet).
Vitesse	vitesse de 1 à 10 : 40 à 200 tr/min
Alimentation	230 V
Puissance	500 W
Capacité	4,5 kg de pâte à gâteau - 2,2 kg de farine - 19 blancs d'oeufs
Dimensions (L x p x H)	37,1 x 28,7 x 41,7 cm
Poids	12,2 kg
Référence	<b>1000777P</b>
P.U.H.T	<b>795,00 €</b>

## 5KPM5



En zinc moulé sous pression.

### 5KPM5

Outils	Bol inox avec poignée. Livré avec kit de pâtisserie (crochet, batteur et fouet).
Vitesse	vitesse de 1 à 10 : 60 à 265 tr/min
Alimentation	230 V
Puissance	315 W
Capacité	2,7 kg de pâte à gâteau - 1 kg de farine - 12 blancs d'oeufs
Dimensions (L x p x H)	26,4 x 33,8 x 41,1 cm
Poids	12 kg
Référence	<b>57195P E</b>
P.U.H.T	<b>628,00 €</b>



robot coupe®



## Votre Partenaire «Fait Maison»



**RM5**, le batteur 5,5 Litres conçu pour les Professionnels !! C'est votre allié quotidien pour les grands classiques de la restauration «fait-Maison»: il flottante, tarte citron meringuée, crème chantilly, soufflés salés ou sucrés, pate à choux, baba etc...

Une attention toute particulière a été portée sur la forme de la cuve et de ses outils (fouet, crochet, palette), afin d'optimiser le volume de travail. Vous apprécierez le basculement de la tête par le levier permettant un dégagement total des outils et une mise en place naturelle de la cuve.

Les batteurs sont livrés avec 3 outils : palette, crochet et fouet.



**Grand rendement**



Écran de sécurité démontable associé au monte et baisse de la cuve inox.



20 L  
50 à 150 couverts



Mélanger  
Pétrir  
Émulsionner  
Fouetter



**XBE20**

Outils	Livré avec 3 outils fouet, palette et crochet spirale
Variateur de vitesse	Electronique
Vitesse	30 à 180 tr/min
Alimentation	Mono 230 V
Puissance	900 W
Capacité de pétrissage (farine en détrempee)	6 kg
Dimensions (L x P x H)	52 x 68,5 x 98 cm
Poids	76 kg
Caractéristique	Avec prise d'accessoire type H (pour coupe-légumes, hachoir ..)
Référence	<b>39083</b> €
P.U.H.T	<b>4 947,00</b> €
Caractéristique	Sans prise d'accessoire
Référence	<b>70398</b> €
P.U.H.T	<b>4 631,00</b> €



10 L  
10 à 50 couverts



Mélanger  
Pétrir  
Émulsionner  
Fouetter



**XBE10**

Outils	Livré avec 3 outils fouet, palette et crochet spirale
Variateur de vitesse	Electronique
Vitesse	26 à 180 tr/min
Alimentation	Mono 230 V
Puissance	750 W
Capacité de pétrissage (farine en détrempee)	3,5 kg
Dimensions (L x P x H)	45,4 x 60,6 x 70 cm
Poids	37 kg
Caractéristique	Avec prise d'accessoire type H (pour coupe-légumes, hachoir ..)
Référence	<b>39084</b>
P.U.H.T	<b>2 757,00</b> €
Caractéristique	Sans prise d'accessoire
Référence	<b>63649</b> €
P.U.H.T	<b>2 605,00</b> €



## BATTEURS MÉLANGEURS



8 L  
10 à 100 couverts  
Livré avec fouet  
+ palette  
+ crochet spirale  
+ cutter 1,7 L



5 L  
0 à 50 couverts  
Livré avec fouet  
+ palette  
+ crochet spirale

 Batteur  
mélangeur

robot coupe® GARANTIE 1 an CE Made in France

Ecran de sécurité démontable, associé au monte et baisse de la cuve inox. Compact et transportable, les RM8 et RM5 sont des batteurs mélangeurs planétaire qui réalisent à merveille toutes les préparations salées ou sucrées de type blancs en neige, chantilly, beurre pommadé, pain, brioche, purée de pommes de terre, mélange de farce, cakes salés...

**RM8**

Utils	Cuve inox 7,6 L, livré avec fouet, palette, crochet spirale et accessoire cutter 1,7 L
Vitesse	10 vitesses indexées de 60 à 600 tr/min
Alimentation	Mono 230 V
Puissance	Asynchrone 700 W
Capacité de pétrissage (farine en détrempee)	4 kg
Dimensions (L x P x H)	31,8 x 46,5 x H. 39,2 cm
Caractéristique	Prise frontale et prise supérieure pour cutter 1,7 L fourni
Poids	21,7 kg
Référence	<b>70150 E</b>
P.U.H.T	<b>1 540,00 €</b>

**RM5**

Utils	Cuve inox 5,5 L, livré avec fouet, crochet spirale et palette
Variateur de vitesse	Electronique
Vitesse	50 à 500 trs/min
Alimentation	Mono 230 V
Puissance	550 W
Capacité de pétrissage (farine en détrempee)	1,2 kg
Dimensions (L x P x H)	31,8 x 46,5 x 40,5 cm
Caractéristique	Prise accessoire frontale
Poids	15,1 kg
Référence	<b>1007757</b>
P.U.H.T	<b>901,00 €</b>

## BATTEUR À PÉTRIN



10 L  
0 à 50 couverts  
Livré avec fourche



## Batteur à pétrin

SANTOS GARANTIE 2 ans CE

Pour tous types de pains, croissants, pâtisserie, pizzas, mélanges de viande hachées. Pétrit 4 kg de pâte dure en 15 minutes. Avec capot protecteur en polycarbonate transparent.

**N18**

Utils	Livré avec fourche
Variateur de vitesse	Electronique
Vitesse	70 trs/min
Alimentation	Mono 230 V
Puissance	600 W
Capacité de pétrissage (farine en détrempee)	4 kg
Dimensions (L x P x H)	35 x 50 x 42 cm
Poids	17 kg
Référence	<b>4633</b>
P.U.H.T	<b>921,00 €</b>





## N62



Permet de réaliser toutes sortes de cocktails, smoothies, jus de fruits, milkshakes, granitas, café frappés... Moteur "brushless" basse consommation. Panneau de contrôle tactile en verre avec écran LCD.

Vitesse	15000 trs / min
Alimentation	230 V
Puissance	3000 W
Capacité	2,4 L
Dimensions (L x P x H)	20 x 25 x 44 cm
Poids	9 kg
Référence	<b>1008294</b>
P.U H.T	<b>1 293,00 €</b>

## Blender N37



C'est l'appareil idéal pour mixer, émulsionner, broyer toutes sortes de préparations chaudes ou froides. Il permet de broyer rapidement les éléments durs (glaçons, carcasse de homard...). Système de verrouillage Santosafe du bol et du couvercle pour une utilisation mains libres. Couteaux ultra résistants. Livré en série avec bol 2 L inox.

Vitesse	0 à 15000 trs / min
Alimentation	230 V
Puissance	1200 W
Capacité	2 L
Dimensions (L x P x H)	22 x 30,3 x 56,6 cm
Poids	11 kg
Référence	<b>1007774</b>
P.U H.T	<b>992,00 €</b>

### Bol complet avec couteaux

Référence	Contenance	Matériau	Quantité	P.U. HT
<b>1007775</b>	2 L	Transparent	x 1	<b>160,00 €</b>
<b>1007776</b>	4 L	Transparent	x 1	<b>167,00 €</b>
<b>1007777</b>	4 L	Inox	x 1	<b>351,00 €</b>

## Tango



"Wave-Action system" design du bol qui recentre les ingrédients vers la lame. Minuterie ajustable de 5 à 40 s. Couvercle avec bouchon doseur. Arrêt du moteur en l'absence du bol. Couteau 4 lames en acier inoxydable.

Vitesse	20000 - 23500 tr/min (+pulse)
Alimentation	230 V
Puissance	750 W
Capacité	1,5 L
Dimensions (L x p x H)	22,9 x 16,5 x H 43,2 cm
Poids	5,75 kg
Référence	<b>63201P</b>
P.U H.T	<b>665,00 €</b>

## Superblender



Le Superblender de KitchenAid est un des blenders les plus puissants du marché, moteur lié à un bloc 4 lames breveté, pour mixer facilement et rapidement vos différents ingrédients.

Vitesse	3,5 CV
Alimentation	230 V
Puissance	1800 W
Capacité	1,78 L
Dimensions (L x p x H)	27 x 29 x H 45,1 cm
Poids	8,93 kg
Référence	<b>1013714</b>
P.U H.T	<b>670,00 €</b>

## Blender N33



Petit mixer de bar performant pour réaliser rapidement toutes sortes de préparations à base de glace pilée : cocktails, smoothies, boissons glacées, jus de fruits, milkshakes... Il est équipé d'une détection de bol : le moteur s'arrête lorsque l'on retire le bol de la base.

Vitesse	13000 - 16000 trs / min
Alimentation	230 V
Puissance	600 W
Capacité	1,25 L
Dimensions (L x P x H)	18 x 18 x 42 cm
Poids	2,9 kg
Référence	<b>1007769P</b>
P.U H.T	<b>298,00 €</b>



1007775      1007776      1007777



nouveau !



nouveau !



## Presse-agrumes auto

**GARANTIE 3 ans**

Automatique, pour tous agrumes, oranges, citrons, mandarines, pommelos. Nettoyage facile et rapide : peu de pièces à démonter. Robinet intelligent : dosage au cl près, pas de perte ni de risque de mauvaise manipulation. Goût et rentabilité uniques : pressage vertical exclusif breveté s'adapte à l'épaisseur de la peau, presse la dernière goutte sans l'amertume du zeste pressé.

	<b>Z14</b>	<b>Z40</b>
Vitesse	55 L/h	150 L/h
Alimentation	230 V	230 V
Puissance	275 W	360 W
Rendement	15 à 20 fruits / minute	40 fruits / minute
Dimensions (L x P x H)	48 x 45 x 79 cm	59 x 54 x 98 cm
Type	Automatique	Automatique
Poids	60 kg	82 kg
Référence	<b>1014055</b>	<b>1014056</b>
P.U.H.T	<b>5 520,00 €</b>	<b>8 290,00 €</b>

## N38



**GARANTIE 2 ans**

Il suffit de couper agrumes, citrons, oranges, pamplemousses en 2 et de presser. Nettoyage facile : tous les éléments dont l'ogive sont amovibles. Livré avec 2 ogives, une pour les citrons et oranges, une pour les pamplemousses.



	<b>N38 Chromé</b>	<b>N38 Jaune</b>
Vitesse	1500 tr/min	1500 tr/min
Alimentation	230 V	230 V
Puissance	130 W	130 W
Rendement	20 à 40 L/h	20 à 40 L/h
Dimensions (L x P x H)	17 x 30 x 35 cm	17 x 30 x 35 cm
Fonctionnement	Manuel	Manuel
Information	Hauteur de bec 13,5 cm	Hauteur de bec 13,5 cm
Poids	5 kg	5 kg
Référence	<b>55617P</b>	<b>38288P</b>
P.U.H.T	<b>404,00 €</b>	<b>323,00 €</b>

nouveau !



## N10



**GARANTIE 2 ans**

Fabrication en acier et aluminium. Bec, ogive amovible perforée, coupelle de pressage et couvercle inox. Repose verre amovible en polycarbonate. Levier de pression. Version peinte.

Vitesse	1500 tr/min
Alimentation	230 V
Puissance	230 W
Rendement	20 à 40 L/h
Dimensions (L x P x H)	20 x 30 x 38 cm
Fonctionnement	Levier
Information	Hauteur de bec 13,5 cm
Poids	9,5 kg
Référence	<b>40580P</b>
P.U.H.T	<b>470,00 €</b>



## Extracteur de jus



Cette nouvelle façon d'extraire du jus, en pressant très lentement toutes sortes de fruits, légumes et herbes, permet de préserver les vitamines, nutriments, enzymes et minéraux. Avec l'extracteur de jus N65, vous pourrez extraire le jus de n'importe quels fruits et légumes et obtenir la consistance que vous souhaitez. Santos possède 2 brevets sur ce système de pressage à froid, ce qui est une réelle innovation sur le marché ! Corps en aluminium et zone alimentaire tout inox. Moteur asynchrone. Vitesse variable et 2 tailles de filtration. Goulotte d'introduction extra large Ø 7,95 cm.

<b>N65</b>	
Vitesse	5 à 80 trs / min
Alimentation	230 V
Puissance	650 W
Capacité	60 L/h
Dimensions (L x P x H)	20 x 35 x 65 cm
Poids	31 kg
Référence	<b>1012021</b>
P.U H.T	<b>3 300,00 €</b>



## Extracteur de jus



Structure 100 % démontable, brosse incluse pour accéder aux orifices du filtre et aux endroits les moins accessibles pour garantir un nettoyage simple, optimal et rapide. Livré avec brosse, filtre supplémentaire pour fruits surgelés, 2 pichets 1L et 1 livre de recettes. Facilement nettoyable. Non conçu pour une utilisation en continu.

Vitesse	60 trs / min
Alimentation	230 V
Puissance	240 W
Dimensions (L x P x H)	29 x 20 x 44 cm
Poids	7,34 kg
Référence	<b>1010741P</b>
P.U H.T	<b>254,00 €</b>





## J80 Ultra

robot coupe® **GARANTIE 1 an**   Made in France

Goulotte automatique pour une alimentation en continu. Faible niveau sonore. Bec verseur anti-goutte. Panier amovible.

Vitesse	3000 tr/min
Alimentation	230 V
Puissance	700 W
Rendement	120 L/h
Dimensions (L x P x H)	23,5 x 42 x 50,2 cm
Taille de goulotte d'insertion	Ø 7,9 cm
Poids	12,5 kg
Référence	<b>64289</b> €
P.U.H.T	<b>1 090,00</b> €

## 1<sup>er</sup> PRIX



## Combiné centrifugeuse/ mixer blender

**Bartscher** **GARANTIE 1 an** 

Livré avec 1 bol en verre 1,8 L (blender) et un bol plastique 1 L (centrifugeuse). Non conçu pour utilisation en continu.

Vitesse	20 000 tr/min fonction pulse
Alimentation	230 V
Puissance	800 W
Dimensions (L x P x H)	29 x 24 x 45 cm
Taille de goulotte d'insertion	Ø 7 cm
Poids	12 kg
Référence	<b>63625P</b>
P.U.H.T	<b>157,00</b> €

## LAITIÈRE



### Laitière

Tout inox. Robinet anti-goutte et thermostat. Protection extérieure contre le "chauffage à sec". Jauge niveau d'eau bain-marie. Poignées isolantes plastique.

ANIMO GARANTIE 1 an CE

Contenance	10 L
Puissance	3200 W
Alimentation	220 - 240 V
Dimensions	Ø 27,4 x H 42,4 cm
Référence	<b>32165 E</b>
P.U H.T	<b>1 103,00 €</b>

## CHAUFFE-EAU



### Chauffe-eau

A remplissage manuel. En acier inoxydable sans soudure. La double paroi en acier inoxydable est isolée par une mousse de polyuréthane. Robinet anti-goutte avec jauge, jauge de réserve, couvercle isotherme, élément de chauffe en acier inoxydable, sécurité contre la chauffe à sec et thermostat. 3200 W. 230 V.

ANIMO GARANTIE 1 an CE

Référence	Dimensions	Capacité	P.U. HT
<b>61362</b>	Ø 23,7 x H. 40,6 cm	5 L	<b>621,00 €</b>
<b>61363</b>	Ø 30,7 x H. 42,7 cm	10 L	<b>697,00 €</b>
<b>61364</b>	Ø 35,5 x H. 51,5 cm	20 L	<b>807,00 €</b>

## PERCOLATEURS



### Percostar

En inox. Equipé d'une sécurité contre la chauffe sans eau, d'un bloc résistance, d'un couvercle répartiteur pour une meilleure utilisation de la mouture, d'une jauge, d'un robinet anti-goutte et d'un système de fermeture du couvercle.

ANIMO GARANTIE 1 an CE

Débit	15 L/h - 120 tasses
Puissance	1500 W
Alimentation	230 V
Dimension	Ø 27,5 x H 60 cm
Poids	5,2 kg
Référence	<b>69736 E</b>
P.U H.T	<b>330,00 €</b>

**1<sup>er</sup> PRIX**



### Percolateur

Boîtier en acier inoxydable. Indicateur de niveau de remplissage. 2 systèmes de chauffe séparés pour infusion ou garde au chaud.

Bartscher GARANTIE 1 an CE

	PRO 100T	PRO 40T
Débit	15 L/h - 110 tasses	6 L/h - 40/48 tasses
Puissance	1600 W	1200 W
Alimentation	230 V	230 V
Dimensions	Ø 27 x H 57,5 cm	Ø 22 x H 48,5 cm
Poids	6,5 kg	4 kg
Référence	<b>66268P E</b>	<b>1002258 E</b>
P.U H.T	<b>164,00 €</b>	<b>123,00 €</b>

Afin de prolonger la durée de vie de l'appareil, et garantir une bonne qualité du café, il faut régulièrement détartrer ! Lors d'une utilisation quotidienne, il faut, toutes les 2 semaines, nettoyer profondément l'appareil pour éliminer toutes graisses, marc de café et dépôts durcis tels que les dépôts de tartre.





## Excelso

ANIMO GARANTIE 1 an CE

Remplissage manuel, sécurité contre la chauffe sans eau. Équipée de plaques de maintien en température autorégulées. Utilisation avec filtre papier standard. Livrée avec une verseuse en verre 1,8 L ou un thermos 2 L ainsi qu'un porte-filtre.

Excelso	
Débit	18L/h - 144 tasses
Capacité	2 verseuses 1,8L
Plaques	2 plaques
Puissance	2250 W
Alimentation	230 V
Dimensions (H x L x P)	43,3 x 19 x 37 cm
Durée d'écoulement	6 minutes/1 verseuse
Poids	6 kg
Référence	<b>51103P E</b>
P.U H.T	<b>281,00 €</b>



Excelso T	
Débit	18L/h - 144 tasses
Capacité	1 thermos 2L
Plaques	1 plaque
Puissance	2275 W
Alimentation	230 V
Dimensions (H x L x P)	47,7 x 19 x 37 cm
Durée d'écoulement	6 minutes/thermos 2 L
Poids	7 kg
Référence	<b>63187P E</b>
P.U H.T	<b>277,00 €</b>



## M-Line

ANIMO GARANTIE 1 an CE

Avec système de détection de la verseuse et système anti-goutte du porte-filtre. Signal sonore lorsque le café est prêt. Dispositif de pré-humidification de la mouture. Indicateur de détartrage. Remplissage du réservoir manuel. Plaque de maintien en température autorégulée. Touches digitales. Carrosserie inox. Livré sans thermos à pompe (réf 1013437).

MT100	
Débit	18L/h - 144 tasses
Capacité	Thermos à pompe 2,2L
Plaques	1 plaque
Puissance	2100 W
Alimentation	230 V
Dimensions (H x L x P)	59,5 x 20,5 x 38 cm
Durée d'écoulement	7,5 minutes / thermos 2,2 L
Poids	7,5 kg
Référence	<b>63186</b>
P.U H.T	<b>392,00 €</b>

1<sup>er</sup> PRIX



## Contessa

En acier inoxydable.

Bartscher GARANTIE 2 ans CE

	<b>1000</b>
Débit	16 L/h
Capacité	Verseuse 1,8 L
Plaques	2 plaques
Puissance	2000 W
Alimentation	230 V
Dimensions	L. 21,5 x l. 38,5 x H. 46 cm
Poids	6,5 kg
Référence	<b>63627P</b> E
P.U H.T	<b>198,00 €</b>

	<b>1002</b>
Débit	15 L/h
Capacité	Thermos 2 L
Plaques	1 plaque
Puissance	2000 W
Alimentation	230 V
Dimensions	L. 21,5 x l. 39 x H. 52 cm
Poids	6,8 kg
Référence	<b>70620</b>
P.U H.T	<b>226,00 €</b>

## ACCESSOIRES



### Verseuse

ANIMO

1,8 L  
**4610** Inox

x 1 P.U.HT  
**40,25 €**



Pour M.line et Excelso.

1,8 L  
**32161P** E Verre

x 1 P.U.HT  
**17,25 €**



### Pichet isotherme

Incassable. Double paroi Inox.

Pichet à bouchon poussoir

2 L  
**70636P** E H. 24,8 cm

x 1 P.U.HT  
**21,50 €**

nouveau !



### Thermos à pompe

ANIMO

Tout inox, double paroi, incassable.  
A utiliser avec les cafetières MT100.

2,1 L  
**1013437** L. 15,5 x l. 15,5 x H. 48 cm

x 1 P.U.HT  
**85,00 €**



### Filter papier ANIMO

Pour M.line et Excelso.

Paquet de 1000  
**4611P** E Ø 9/25 cm

x 1 P.U.HT  
**21,25 €**



### Détartrant\*

48 sachets de 50 g  
**39156\***

x 1 P.U.HT  
**59,00 €**



30 sachets de 15 g  
**70583P\*** E

x 1 P.U.HT  
**19,75 €**

\* Dangereux. Respecter les précautions d'emploi.  
Produit conforme à la législation française.





## Toaster convoyeur

**Bartscher** GARANTIE 1 an

Le toaster convoyeur est conçu pour une demande de production importante (jusqu'à 150 toasts / heure) grâce à son système d'avancement horizontal. Vous pouvez disposer les toasts sur 2 rangées. Idéal pour griller différents types de pain, pain de mie ou similaire. Permet de faire griller les 2 faces en même temps. Convient pour les hôtels, auberges pour le petit déjeuner par exemple.

Capacité	2 tranches en largeur
Débit	150 toasts/h
Puissance	2240 W
Alimentation	230 V
Dimension extérieure (L x l x H)	36,8 x 44 x 38,5 cm
Poids	17,4 kg
Référence	<b>69539</b>
P.U.H.T	<b>572,00 €</b>



## Toaster

**Bartscher** GARANTIE 1 an

Appareil à toaster/gratiner. Boîtier en acier inoxydable. Résistance en quartz. Minuterie de 15 minutes. 1 ou 2 grilles selon modèle. Tiroir ramasse-miettes. Pince à toasts incluse.

	<b>2 étages</b>
Capacité	6 à 8 toasts
Débit	300 toasts/h
Puissance	3000 W
Alimentation	230 V
Surface utile (L x l x H)	35,5 x 24 x 5 cm x 2
Dimension extérieure (L x l x H)	44 x 26 x 40 cm
Poids	9,7 kg
Référence	<b>68255</b>
P.U.H.T	<b>232,00 €</b>



	<b>1 étage</b>
Capacité	4 à 6 toasts
Débit	150 toasts/h
Puissance	1700 W
Alimentation	230 V
Surface utile (L x l x H)	35,5 x 24 x 5 cm
Dimension extérieure (L x l x H)	44 x 26 x 29 cm
Poids	8,2 kg
Référence	<b>68254</b>
P.U.H.T	<b>185,00 €</b>





## Grille-pain

Rowlett **GARANTIE 1 an**

En inox brossé. Avec minuterie, interrupteur et réglage de la chaleur. Tranches épaisseur maximum 2 cm, longueur 12 cm.

6 tranches	
Puissance	3300 W
Alimentation	230 V
Dimensions (L x l x H)	46 x 21 x 22,5 cm
Poids	7,6 kg
Référence	<b>1004324</b>
P.U.H.T	<b>337,00 €</b>



## Grille-pain Artisan

KitchenAid **GARANTIE 1 an**

En aluminium moulé. Grille pain 4 tranches extra larges pour tous types de pains. Fonctions maintien au chaud automatique, sandwich, décongélation, petits pains ronds. 7 degrés de brunisseurs avec minuteur led.

4 tranches	
Puissance	2500 W
Alimentation	230 V
Dimensions (L x l x H)	34,8 x 30,4 x 20,5 cm
Poids	7,5 kg
Référence	<b>1002566P</b>
P.U.H.T	<b>335,00 €</b>

**1<sup>er</sup> PRIX**



## Grille-pain Silver Line

Bartscher **GARANTIE 1 an**

En acier inoxydable. Pour usage non intensif. Peut aussi griller des sandwichs (fentes de 4 x 14 cm). Réglage indépendant de chaque couple de fentes par propre levier de commande. 7 niveaux de toastage. Livré avec grilles amovibles pour pain et tiroir ramasse-miettes.

4 tranches	
Puissance	1400 W
Alimentation	230 V
Dimensions (L x l x H)	32 x 27 x 19,5 cm
Poids	3,1 kg
Référence	<b>68256P</b>
P.U.H.T	<b>79,50 €</b>



2 tranches	
Puissance	800 / 900 W
Alimentation	220 / 240 V
Dimensions (L x l x H)	19 x 26,5 x 19,5 cm
Poids	1,85 kg
Référence	<b>1013589P</b>
P.U.H.T	<b>49,25 €</b>



## GRILLS

Plaque supérieure libre, se positionne automatiquement en fonction de l'épaisseur du produit. Légère à manipuler

Flexible IP 44



### Contact Grill

Appareil en acier inoxydable. Plaques en fonte d'acier. Thermostat de 50 °C à 300 °C. Témoin de chauffe lumineux. Témoin lumineux marche/arrêt. Bac de récupération des graisses.



	A - Grill double	B - Grill
Adapté pour	Panini	Panini
Type de plaques	Rainurée	Rainurée
Puissance	4400 W	3000 W
Alimentation	230 V	230 V
Dim utile (L x l)	2 x 25 x 20 cm	34 x 28 cm
Dimension (L x l x H)	58 x 45 x 50 cm	38 x 55 x 65 cm
Poids	36 kg	38 kg
Référence	<b>69779</b>	<b>69778</b>
P.U.H.T	<b>936,00 €</b>	<b>770,00 €</b>



### Grill

En acier inoxydable. Plaques en fonte d'acier. Thermostat 50°C à 300°C. Témoins lumineux de chauffe et on/off. Bac de récupération des graisses. Brosse de nettoyage incluse.



	A - Grill double	B - Grill	C - Grill
Adapté pour	Toutes cuissons	Panini	Steak, hamburgers
Type de plaques	Rainurée	Rainurée	Rainurée
Puissance	3600 W	2200 W	1800 W
Alimentation	230 V	230 V	230 V
Dim plaque supérieure (L x l)	2 x 21,5 x 21,5 cm	33,5 x 22 cm	21,4 x 21,4 cm
Dim plaque inférieure (L x l)	47 x 23 cm	33,5 x 23 cm	22 x 23,5 cm
Dimension (L x l x H)	57 x 37 x 20 cm	41 x 37 x 20 cm	29 x 37 x 20 cm
Poids	26 kg	19 kg	14 kg
Référence	<b>69536</b>	<b>68253P</b>	<b>68248</b>
P.U.H.T	<b>449,00 €</b>	<b>294,00 €</b>	<b>247,00 €</b>



## SALAMANDRE



### Salamandre

Construction en inox, toit mobile. 2 zones de chauffe par résistance infrarouge. La salamandre permet de décongeler, dorer, glacer, gratiner, griller les toasts, gratins, pizzas, soupes à l'oignon ... Sans préchauffage. Le libre passage de la voûte permet d'utiliser toutes les dimensions de plats. Lèche-frite. Grille fournie.



Zone de chauffe	2 par résistances à infrarouges
Puissance	4000 W
Alimentation	400 V
Surface de cuisson (L x l)	55,7 x 32,5 cm
Dimension (L x l x H)	64 x 54 x 53 cm
Poids	49,5 kg
Référence	<b>69540</b>
P.U.H.T	<b>802,00 €</b>





## PLANCHAS



A



B



Gants anti-chaaleur, voir page 426



### Plancha

**Krampouz** GARANTIE 1 an

Plaque de cuisson inox, certifiée contact alimentaire, avec rebords. Châssis inox avec aération renforcée. Bac amovible de récupération des jus et des déchets. 4 pieds réglables. 2 interrupteurs marche/arrêt. 2 voyants de mise sous tension. 2 thermostats.

	A - 64 x 34	B - 34 x 64
Matière de la plaque	Inox	Inox
Type de plaques	Lisse	Lisse
Puissance (W)	1200 W	1200 W
Alimentation (V)	230 V	230 V
Surface utile	64 x 34 cm	34 x 64 cm
Dimension (cm)	70 x 37,6 x H 23 cm	40 x 69 x H 26,6 cm
Poids (kg)	17 kg	19 kg
Référence	<b>1011091</b>	<b>1011092</b>
P.U.H.T	<b>517,00 €</b>	<b>575,00 €</b>

### Plancha

**Bartscher** GARANTIE 1 an

Grill de table électrique avec plaque en fonte d'acier. Thermostat réglable de 50° C à 270° C. Témoin lumineux de chauffe. Arrêt de chauffe thermostatique. 4 pieds à vérins réglable.

Type de plaque	Fonte d'acier lisse
Puissance (W)	3000 W
Alimentation (V)	230 V
Surface utile (cm)	32 x 48 cm
Dimension (cm)	32,5 x 54 x H. 29,5 cm
Poids (kg)	22 kg
Référence	<b>68257</b>
P.U.H.T	<b>408,00 €</b>

### Grattoir à plancha

**TABLECRAFT**  
EVERY WARE, EVERY DAY™

<b>1011087</b>	L. 38 x l. 16,5 cm	x 1	<b>95,00 €</b>
<b>1011089</b>	Bande caoutchouc - L. 15 cm	x 1	<b>14,30 €</b>
<b>1012560P</b>	Lame aluminium - L. 15 cm	x 6	<b>4,70 €</b>

<b>P.U.H.T</b>	
x 1	<b>95,00 €</b>
x 1	<b>14,30 €</b>
x 6	<b>4,70 €</b>





2 x 8 L



8 L



4 L



Testeur d'huile,  
voir page 399



## Friteuse avec robinet

**Bartscher** GARANTIE 1 an

Friteuse électrique avec vanne de vidange. Boîtier, couvercle, tableau de commande en acier inoxydable. Cuves embouties. Thermostat de sécurité (protection anti-surchauffe). 2 prises de courant nécessaires pour la version 2 cuves. Livrée avec panier.

	<b>2 x 8 L</b>
Puissance	2 x 3250 W
Alimentation	2 x 230 V
Dimension (L x l x H)	58 x 55 x 41 cm
Poids	22 kg
Référence	<b>69534</b>
P.U.H.T	<b>484,00 €</b>

	<b>8 L</b>
Puissance	3250 W
Alimentation	230 V
Dimension (L x l x H)	29 x 55 x 41 cm
Poids	10 kg
Référence	<b>69535P</b>
P.U.H.T	<b>281,00 €</b>

## Friteuse

**Bartscher** GARANTIE 1 an

Boîtier, couvercle, tableau de commande en acier inoxydable. Panier fourni. Thermostat de sécurité (protection anti-chauffe).

	<b>4 L</b>
Puissance	2000 W
Alimentation	230 V
Dimension (L x l x H)	22 x 40 x 31,5 cm
Poids	7 kg
Référence	<b>63629P</b>
P.U.H.T	<b>133,00 €</b>

## Filtere à huile



<b>45P</b>	Filtere complet	x 1	<b>113,00 €</b>
<b>46</b>	Toile de rechange	x 1	<b>73,50 €</b>



P.U.H.T

## Pelle à frites

Inox. Conçue pour les droitiers. Manche 14 cm. Passe au lave-vaisselle.

<b>69364P</b>	L. 23 x l.21 cm	x 1	<b>12,90 €</b>
---------------	-----------------	-----	----------------



P.U.H.T



Système de chauffage à sec.  
Pas d'écoulement d'eau lors de  
la sortie de la brique.  
Idéal pour les briques de lait,  
chocolat, soupe.  
Hygiène optimale.  
Livré avec une pince brique.

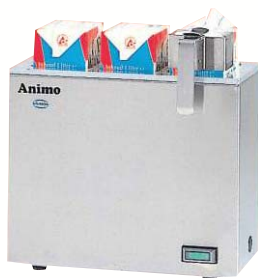

32164



63630P



69781P



54604P



1006344



1006352P



1013402



68243

## Chauffe-briques

ANIMO GARANTIE 1 an CE

Bain-marie "sec". Carrosserie inox, cavités en fonte d'aluminium. Livré avec une pince permettant de retirer aisément la brique et de verser directement.

Capacité	3 x 1 L	6 x 1 L
Dimensions (L x l x H)	27 x 15 x 24 cm	31,5 x 34 x 24 cm
Puissance	1100 W	2200 W
Alimentation	230 V	230 V
Poids	9 kg	18 kg
Référence	<b>32164 E</b>	<b>62641 E</b>
P.U.H.T	<b>499,00 €</b>	<b>841,00 €</b>

## Bain-marie

Bartscher GARANTIE 1 an CE

Bain marie avec robinet d'évacuation d'eau. Produit en acier inoxydable qui peut recevoir un bac GN1/1 avec de multiples profondeurs ne dépassant pas 200 mm. Livré sans bac.

Robinet de vidange	Oui
Puissance	1200 W
Alimentation	230 V
Dimensions (L x l x H)	35,5 x 55 x 29,5 cm
Poids	9,5 kg
Référence	<b>63630P</b>
P.U.H.T	<b>210,00 €</b>

## Cuiseur à oeufs

SOFRACA GARANTIE 1 an CE Made in France

Construction tout inox. Thermostat de régulation. Résistances directes dans l'eau pour une diffusion plus rapide de la chaleur. Embouts de couleur pour un repérage facile de son œuf. Livré avec 6 paniers.

Capacité	6 paniers de couleur
Puissance	2000 W
Alimentation	230 V
Dimensions (L x l x H)	36 x 20 x 29 cm
Poids	3 kg
Référence	<b>69781P</b>
P.U.H.T	<b>357,00 €</b>

## Cuiseur à oeufs

ROLLER GRILL GARANTIE 1 an CE Made in France

Livré avec 6 paniers numérotés et un bac gastro 1/3 tout inox, lavables en machine. Thermostat de régulation et thermostat de sécurité. Voyant de contrôle. Capacité de cuisson : 10 œufs max, avec paniers supplémentaires.

Capacité	6 paniers numérotés
Puissance	1200 W
Alimentation	230 V
Dimensions (L x l x H)	21,5 x 43 x 25,5 cm
Poids	4,5 kg
Référence	<b>54604P</b>
P.U.H.T	<b>286,00 €</b>

## Cuiseur à pâtes / riz

GARANTIE 1 an CE

**1006344 - Cuiseur à pâtes :** Acier inoxydable. Dim. cuve : L. 24 x l. 30 x H 20 cm. Plage de température jusqu'à 110 °C. 1 panier inclus.

**1006352 - Cuiseur à riz :** Boîtier en inox. Grosses poignées. Cuve anti-adhésive, résistante à la chaleur. Fonction de maintien en température.

Livré avec 1 doseur, 1 cuillère à riz, 1 cuillère à pot.

**1013402 - Cuiseur à riz :** Livré avec un verre doseur et une cuillère à riz. Facile à nettoyer, cuve en aluminium amovible.

	Bartscher Cuiseur à pâtes	Bartscher Cuiseur à riz	HENDI FOODSERVICE EQUIPMENT Cuiseur à riz
Capacité	7 L	8 L	1,8 L
Puissance	3400 W	1950 W	700 W
Alimentation	230 V	230 V	230 V
Dimensions (L x l x H)	27 x 42 x 30 cm	Ø 38,4 x 37,5 cm	Ø 28 x 28,5 cm
Poids	6,75 kg	11 kg	3,30 kg
Référence	<b>1006344</b>	<b>1006352P</b>	<b>1013402</b>
P.U.H.T	<b>401,00 €</b>	<b>204,00 €</b>	<b>34,00 €</b>

## Chauffe-saucisses

Bartscher GARANTIE 1 an CE

En acier inoxydable. 4 plots chauffés. Cylindre en verre : Ø 20 cm, H. 24 cm. Température réglable de 40 °C à 100 °C.

Puissance	960 W
Alimentation	230 V
Dimensions (L x l x H)	50 x 28,5 x 39 cm
Poids	8,7 kg
Référence	<b>68243</b>
P.U.H.T	<b>329,00 €</b>



## CRÊPIÈRES



## Crêpière électrique

Krampouz

GARANTIE 1 an



Bâti inox, plaque fonte. Équipé d'une résistance en serpentín pour une diffusion uniforme de la chaleur. Voyant de mise sous tension. Témoin de chauffe. Thermostat réglable 50°C à 300°C. Manette graduée.

Alimentation	230 V
Puissance	3000 W
Dimensions (L x H)	Ø 40 x 12,5 cm
Poids	16 kg
Référence	39100P
P.U.H.T	315,00 €



## Crêpière gaz

Krampouz

GARANTIE 1 an



Bâti inox, plaque fonte. Équipé d'un brûleur en forme d'étoile à 6 branches. Réglage de flamme. Équipé d'un robinet à sécurité thermo-couple gaz/butane/propane/gaz naturel, qui coupe le gaz en cas d'extinction accidentelle.

Alimentation	Gaz (brûleur 6 branches)
Puissance	6000 W
Dimensions (L x H)	Ø 40 x 18,5 cm
Poids	15 kg
Référence	1000555
P.U.H.T	299,00 €



## Râteau à crêpe

En bois.

52482P L. 18 x l. 18 cm



x 5

P.U.H.T

1,50 €

## Spatule à crêpe

En hêtre.

70409 L. 40 x l. 4,7 cm



x 1

P.U.H.T

2,90 €

## GAUFRIERS



nouveau !

Pour gaufres fraîches

## Gaufrier

Krampouz

GARANTIE 1 an



Système Easy Clean. Poignées droites. Chassis en inox. Fers en fonte d'acier certifiée contact alimentaire. Plateau récupérateur de déchets. Manettes de commande protégées. Interrupteur marche/arrêt intégré dans le bouton de commande. Voyant de mise sous tension. Régulation thermostatique de 50°C à 300°C. Témoin de chauffe. Système d'isolation thermique de la résistance.

	A - Gaufre	B - Gaufre	C - Churros
Capacité	2 Gaufres	2 Gaufres	16 Churros
Ouverture	180°	90°	180°
Puissance	1800 W	1800 W	1800 W
Alimentation	240 V	230 V	240 V
Dimensions (L x l x H)	26 x 44 x 20 cm	26 x 31,5 x 22 cm	26 x 44 x 22 cm
Poids	20 kg	19 kg	20 kg
Référence	1013536	1007761	1007762
P.U.H.T	736,00 €	618,00 €	732,00 €

## CHAUFFE-CHOCOLAT



## Chauffe-chocolat



GARANTIE 1 an



Thermostat commutateur pour une parfaite régulation de la température sans surchauffe ni dessèchement. Résistance autour du bac inox. Minuterie électronique. Présentoir retirable pour pot de confiture, miel, pâte à tartiner ou flacon de coulis. Livré avec 2 bouteilles 1 L à pression munies de 3 sorties pour un dosage facile, précis et hygiénique.

Capacité	1 L
Puissance	170 W
Alimentation	230 V
Dimensions (L x l x H)	22,5 x 17,5 x 22 cm
Poids	2 kg
Référence	1006295
P.U.H.T	283,00 €

# WOK ET PLAQUES À INDUCTION



## Wok et plaque à induction



Boîtier en acier inoxydable. Panneau de contrôle tactile avec affichage digital. Protection électrique anti-surchauffe. Wok inox avec couvercle. Plaque et wok vendus séparément. Plage de température : 60°C à 240°C

WOK IW 35 PRO	
Puissance	3500 W
Alimentation	230 V
Dimensions (L x l x H)	35,5 x 43,9 x 16,7 cm
Poids (hors sauteuse)	7,5 kg
Info +	Surface de cuisson concave en Schott Ceran, Ø 30 cm
Réf. Sauteuse wok	<b>1006351</b> (Ø 38 cm / 5 L)
<b>P.U H.T</b>	<b>105,00 €</b>
Réf. Plaque induction	<b>1006349</b>
<b>P.U H.T</b>	<b>1 029,00 €</b>



WOK IW35	
Puissance	3500 W
Alimentation	230 V
Dimensions (L x l x H)	34 x 44 x 12,5 cm
Poids (hors sauteuse)	6,9 kg
Info +	Surface de cuisson concave en verre, Ø 26 cm
Réf. Sauteuse wok	<b>1006350</b> (Ø 36 cm / 6 L)
<b>P.U H.T</b>	<b>113,00 €</b>
Réf. Plaque induction	<b>1006348</b>
<b>P.U H.T</b>	<b>325,00 €</b>

Non prévu pour un usage en continu.



## Plaque à induction



Boîtier en acier inox. Surface en vitrocéramique Schott : qualité et rapidité de la conduction de chaleur, résistance aux rayures, presque incassable. Panneau de contrôle tactile en "Touch glass" avec affichage digital pour une meilleure étanchéité. Minuterie. 10 niveaux de puissance (400 à 3000 W). Thermostat de sécurité électronique.

IK30TCS	
Plage de température	60°C - 240° C
Puissance	3000 W
Alimentation	230 V
Dimensions (L x l x H)	33 x 41,5 x 10 cm
Poids	5,5 kg
Référence	<b>69344P E</b>
<b>P.U H.T</b>	<b>265,00 €</b>





DAEWOO ELECTRONICS  
GARANTIE 1 an CE

## Four micro ondes

	Digital
Capacité	27 L
Puissance	1800 W
Alimentation	230 V
Dim. int. (L x l x H)	37,1 x 37 x 19,8 cm
Dim. ext. (L x l x H)	46,5 x 56,3 x 37 cm
Caractéristique	Extérieur inox, cavité en céramique. Double magnétron. 4 niveaux de puissance. Filtre à air amovible, bouton + 20 secondes, porte à poignée, grande fenêtre d'affichage et superposable. Rappel automatique de nettoyage du filtre à air.
Poids	33 kg
Référence	<b>1004326</b>
P.U H.T	<b>1 260,00 €</b>

Self - Touche unique



## Four micro ondes

MENUMASTER Commercial  
GARANTIE 1 an CE

	Digital
Contenance	25 L
Puissance restituée	1000 W
Puissance absorbée	1150 W
Alimentation	230 V
Dim. int. (L x l x H)	33 x 33 x 19,6 cm
Dim. ext. (L x l x H)	50,8 x 41,9 x 31,1 cm

### Caractéristique

Pour réchauffage en cuisine ou en salle. 5 niveaux de puissance, 20 menus programmables. Extérieur en inox, intérieur en époxy, porte en ABS. Antenne tournante et sole fixe en céramique GN 2/3. Magnétron ventilé pour une plus grande longévité. Remise à 0 de la minuterie à ouverture de la porte. Permet d'accueillir des assiettes de 30,5 cm. Modèle SELF : utilisation en self service aisée grâce à la touche unique préprogrammée à 45 secondes.

Poids	15 kg
Référence	<b>69352P E</b>
P.U H.T	<b>645,00 €</b>



pro.cooker  
GARANTIE 1 an CE

## Four micro ondes

	Digital
Capacité	25 L
Puissance restituée	1000 W
Puissance absorbée	1550 W
Alimentation	230 V
Dim. ext. (L x l x H)	51,1 x 42,1 x 28,5 cm
Caractéristique	10 niveaux de puissance, 10 menus programmables. Extérieur inox, intérieur époxy. Sole en céramique fixe GN 2/3 pour assiette Ø 30,5 cm.
Poids	13,5 kg
Référence	<b>1002157P E</b>
P.U H.T	<b>527,00 €</b>



	Digital
Contenance	28 L
Puissance restituée	900 W
Puissance absorbée	1450 W
Alimentation	230 V
Dim. int. (L x l x H)	32,5 x 32 x 20,5 cm
Dim. ext. (L x l x H)	51,2 x 43,2 x 30,5 cm

### Caractéristique

Fonction grill (1150W) et décongélation. 5 niveaux de puissance. Nombreux programmes. Signal de fin de cuisson. Sécurité enfant. Plateau en verre tournant Ø 31,5 cm.

Poids	15,5 kg
Référence	<b>1007319P</b>
P.U H.T	<b>212,00 €</b>







Mécanique	
Capacité	20 L
Puissance restituée	700 W
Puissance absorbée	1050 W
Alimentation	230 V
Dim. int. (L x l x H)	27 x 25,5 x 17 cm
Dim. ext. (L x l x H)	44 x 33,5 x 25,8 cm
Caractéristique	Fonction grill (1000W) + décongélation. 5 niveaux de puissance. Signal de fin de cuisson. Sécurité enfant. Plateau en verre tournant Ø 25,5 cm.
Poids	10,2 kg
Référence	✓ 1002158P €
P.U.H.T	120,00 €

## Etagère pour micro-ondes

**TOURNUS**  
EQUIPEMENT

Construction en acier inoxydable. Etagères à plateau, épaisseur 1,2 mm. Dossieret arrière H. 40 mm, en retrait du mur de 40 mm. Charge maxi : 100 kg répartis (suivant nature de la paroi). Fixation murale par 4 vis.

1003412 E L. 60 x l. 50 x H. 11 cm.



x 1

P.U.H.T  
101,00 €

Dont Éco-participation  
0,14 €

## DÉSHYDRATEUR

nouveau !



## Déshydrateur

**HENDI**  
FOOD SERVICE EQUIPMENT

GARANTIE 1 an  
CE

Pour sécher fruits, légumes, herbes, viande, poisson etc. Des ventilateurs automatiques font circuler l'air chaud pour obtenir un résultat homogène. Équipé avec 6 plateaux en inox de 33x30,5 cm, supportant 500 g d'aliments chacun. Vous pouvez surveiller le séchage grâce à la porte transparente. Livré avec un tapis transparent qui peut être utilisé comme égouttoir au fond du déshydrateur ou pour faire du cuir de fruit. Température réglable de 35° à 70°C. 500 W. 230 V.

1013401 L. 45 x l. 34,5 x H. 31,5 cm.



x 1

P.U.H.T  
116,00 €

## FOUR À CONVECTION NATURELLE



Produit décapant four voir page 473



## Four à convection

**Bartscher** GARANTIE 1 an  
CE

Une cuisson égale sur tout le produit. Viandes et volailles rôtissent tout en restant juteuses à cœur. Les viennoiseries gonflent à merveille et les pâtisseries sortent plus appétissantes d'un four à convection que d'un four statique.

AT90	
Contenance	60 L
Puissance	2670 W
Alimentation	230 V
Dimensions intérieures (L x l x H)	47 x 37 x 34 cm
Dimensions extérieures (L x l x H)	61,5 x 59,5 x 57 cm
Caractéristique	Four à chaleur tournante, 2 ventilateurs. Habillage en acier inoxydable. Enceinte de cuisson émaillée. 4 niveaux (43,3 x 33,3 cm). Thermostat, minuterie. Porte à double vitrage. Avec 2 moteurs. Espacement entre les grilles 7 cm. 4 plaques incluses.
Poids	38 kg
Référence	68320
P.U.H.T	541,00 €





Le principe du sous vide est de retirer l'oxygène dans le sac où se trouve l'aliment, empêchant ainsi le développement des bactéries et augmentant sa durée de vie.



### Machine sous vide

Entièrement en inox. Touche d'arrêt de cycle. Commande électronique.



	A - Plusvac 20 mono	A - Plusvac 20 Tri	B - Vacuboy
Longueur de soudure	40,5 cm	40,5 cm	35 cm
Pompe à vide	21 m³/H	21 m³/H	10 m³/H
Puissance	1000 W	1000 W	630 W
Alimentation	230 V	400 V	230 V
Dim. int (L x l x H)	48 x 65,5 x 38,5 cm	48 x 65,5 x 38,5 cm	36 x 38 x 14 cm
Dim. ext (L x l x H)	43 x 50,5 x 17,5 cm	43 x 50,5 x 17,5 cm	40 x 50 x 36 cm
Poids	70 kg	70 kg	40 kg
Référence	<b>1011763</b>	<b>1011762</b>	<b>1011765</b>
P.U.H.T	<b>4 642,00 €</b>	<b>4 781,00 €</b>	<b>3 126,00 €</b>

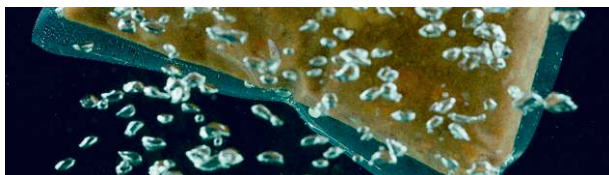

### Sac de cuisson universel

Sac tubulaire. Epaisseur 90 µ. En polyamide et polyéthylène. De -40°C / + 115 °C.

		P.U.HT
<b>1004765P</b>	L. 60 x l. 40 cm - 750 cl - Paquet de 600	<b>291,00 €</b>
<b>1004766P</b>	L. 40 x l. 30 cm - 375 cl - Paquet de 600	<b>154,00 €</b>
<b>1004767P</b>	L. 30 x l. 20 cm - 150 cl - Paquet de 1000	<b>128,00 €</b>



### Sac de conservation universel

Possède les propriétés idéales pour emballer la viande, la charcuterie, le poisson, le fromage, l'épicerie fine et les plats cuisinés. En polyamide et polyéthylène. Epaisseur 90 µ. De -50°C / + 90°C.

Paquet de 100		P.U.HT
<b>69499P</b>	L. 50 x l. 30 cm	<b>27,25 €</b>
<b>69498P</b>	L. 40 x l. 30 cm	<b>24,75 €</b>
<b>69497P</b>	L. 30 x l. 25 cm	<b>16,50 €</b>
<b>69496P</b>	L. 30 x l. 20 cm	<b>15,50 €</b>
<b>69495P</b>	L. 20 x l. 15 cm	<b>6,50 €</b>

### Machine sous vide

Entièrement automatique avec possibilité de revenir en mode manuel. Largeur maxi des sachets 30 cm. Sécurité empêchant les liquides de pénétrer dans la pompe. Protection thermique sur la pompe et du système de soudure. Livrée avec 20 sachets 20 x 30 cm.



	<b>05S</b>
Longueur de soudure	33 cm
Pompe à vide	1 m³/h
Puissance	250 W
Alimentation	230 V
Dim interieur (L x l x H)	37 x 17 x 10 cm
Poids	3 kg
Vide maximum possible	850 mbar
Référence	<b>1000559</b>
P.U.H.T	<b>201,00 €</b>



### Sac sous vide 05S

Sac gaufré en polyéthylène à l'intérieur et en nylon à l'extérieur.

Paquet de 100		P.U.HT
<b>1005092</b>	L. 40 x l. 30 cm	<b>73,50 €</b>
<b>1005093P</b>	L. 30 x l. 20 cm	<b>38,75 €</b>
<b>1005094</b>	L. 25 x l. 15 cm	<b>25,25 €</b>





1004314

nouveau !



1013519

## Thermoplongeur

Pour une cuisson précise et optimale sous vide.

DELCOUPE

GARANTIE 1 an CE

	Thermocook	Thermoplongeur THC
Capacité	50 L	15/20 L
Puissance	2000 W	800 W
Alimentation	230 V	230 V
Température de chauffe (précision)	40 à 115 °C (+/- 0,3 °C)	0 à 90 °C
Dimensions (L x l x H)	26 x 13 x 48 cm	37,7 x 7,8 x 10,5 cm
Poids	10 kg	1 kg
Caractéristique	Construction en inox. Ecran tactile LCD. Fixation arrière universelle pour tous types de bacs (hauteur maximale 20 cm).	Affichage électronique de la température et du temps en cours.
Référence	1004314	1013519
P.U.H.T	1 253,00 €	421,00 €

## MAINTIEN AU CHAUD

Câble extensible de 30 à 110 cm



## Lampe chauffante infrarouge

Lacor GARANTIE 1 an CE

Aluminium. Avec interrupteur et ampoule blanche 275 W. Pour le maintien en température de vos préparations au-dessus des passe-plats ou des buffets. Poids 1,6 kg. 230V.

1010742P Ø 23 x H. 23 cm



x 1

P.U.H.T 95,50 €



## Rampe chauffante infrarouge

Bartscher GARANTIE 1 an CE

Réchauffage uniforme et maintien en température sans dessécher. Facile à adapter et à déplacer. Utilisation sur pieds (en option) ou suspendu au plafond.

	Pont	Paire de pieds pour pont
Dimensions (L x l x H)	76 x 20,5 x 6,5 cm	H. 37 cm
Puissance	650 W	
Alimentation	230 V	
Poids	4 kg	75 g
Caractéristique	Livré sans pieds	
Référence	69537	69728
P.U.H.T	204,00 €	74,50 €



68247



68244

## Chauffe-assiettes

Bartscher GARANTIE 1 an CE

Appareil pour assiettes jusqu'à Ø 32 cm. Construction en acier inoxydable. Etagère ajustable sauf sur 68247.

Nb. d'assiettes	30/40	110/120	55/60	25/30
Thermostat	30 à 80 °C	0 à 85 °C	0 à 85 °C	0 à 85 °C
Puissance	600 W	1200 W	750 W	400 W
Alimentation	230 V	230 V	230 V	230 V
Dimensions (L x l x H)	Ø 46 x 57,5 cm	75 x 51 x 85,5 cm	45 x 51 x 85,5 cm	45 x 40,5 x 54,5 cm
Poids	21,6 kg	49 kg	33 kg	24 kg
Référence	68247	68246	68245	68244
P.U.H.T	603,00 €	648,00 €	381,00 €	319,00 €



## Chariot chauffant 2 piles d'assiettes

TOURNAIS EQUIPEMENT GARANTIE 1 an CE

Angles intérieurs rayonnés pour faciliter le nettoyage. Poignées de guidage en tube inox Ø 25 mm. 4 butoirs de protection en polyéthylène. 4 roues pivotantes Ø 12,5 cm à chape polyamide avec roulement à billes dont 2 à frein. Distributeurs à niveau constant amovibles, hauteur d'empilage 58 cm, soit environ 60 assiettes Ø 18 à 29 cm par pile. Mise sous tension par un interrupteur marche/arrêt avec voyant. Régulation de la chauffe par un thermostat mécanique réglable de 0 à 90 °C. Chauffe assurée par 21 résistances blindées inox disposées sur les côtés. Isolation par laine de roche. Puissance 800 W (1 pile) et 1500 W (2 piles). Tension 230 V. Chariot livré avec couvercles en polycarbonate transparent.

60751 E L. 90 x l. 48,5 x H. 91,5 cm



x 1

P.U.H.T 1 326,00 €

Dont Éco-participation 0,92 €



Pesage, tarage, totalisation des pesées  
20 mémoires de tare



IP 67



IP 56



IP 54



IP52 : Protection contre les poussières + protégé contre les chutes de gouttes d'eau jusqu'à 15° par rapport à la verticale.

IP54 : Protection contre les poussières + protégé contre les projections d'eau de toutes les directions.

IP56 : Protection contre les poussières + protégé contre les projections d'eau assimilables aux paquets de mer.

IP67 : Protection contre la pénétration de poussière (étanche) + protégé contre les effets de l'immersion entre 0,15 et 1m.



## Balance Ambiance humide



Caractéristiques	Contrôle +/-, pesage en %, sortie RS232 pour PC ou imprimante. Livré avec support mural et colonne inox.	
Alimentation	Bloc secteur détachable 230V - 50/60 Hz - 11V AC + batterie rechargeable autonomie 70 h.	
Affichage	Affichage rétro-éclairé H 2,5cm, bleu	
T° d'utilisation	-10 à +40°C	
Protection froid/chaud	Protection contre les chocs thermiques	
Portée	60 kg	150 kg
Précision	5 g	10 g
Plateau inox (L. x l.)	35 x 30 cm	50 x 40 cm
Poids	11 kg	16 kg
Référence	<b>1001293 E</b>	<b>1001294</b>
P.U H.T	<b>602,00 €</b>	<b>807,00 €</b>

## Balance Ambiance sèche



Caractéristiques	Contrôle +/-, pesage en %, sortie RS232 pour PC ou imprimante. Livré avec support mural et colonne inox.	
Alimentation	Bloc secteur détachable 230V - 50/60 Hz - 11V AC + batterie rechargeable autonomie 70 h.	
Affichage	Affichage rétro-éclairé H 2,5 cm, bleu	
T° d'utilisation	+10 à +40°C	
Protection froid/chaud	non	
Portée	60 kg	150 kg
Précision	10 g	20 g
Plateau inox (L. x l.)	45 x 35 cm	50 x 40 cm
Poids	11,5 kg	14 kg
Référence	<b>68224 E</b>	<b>68225 E</b>
P.U H.T	<b>357,00 €</b>	<b>377,00 €</b>

## Balance Éco Ambiance sèche



Caractéristiques	Indicateur solidaire du plateau ou fixation murale	
Alimentation	220V - 50/60 Hz - 11V AC	
Affichage	Affichage rétro-éclairé H 2,5 cm bleu	
T° d'utilisation	+ 10 à + 40°C	
Protection froid/chaud	non	
Portée	30 kg	150 kg
Précision	10 g	50 g
Plateau inox (L. x l.)	40 x 30 cm	50 x 40 cm
Poids	6,3 kg	11,8 kg
Référence	<b>1001291 E</b>	<b>1001292 E</b>
P.U H.T	<b>193,00 €</b>	<b>204,00 €</b>



## BALANCES DE LABORATOIRE



IP 56



Grand plateau



IP 65



Face arrière



### Balance Ambiance sèche



Batterie incorporée rechargeable. Bloc alimentation secteur détachable. Housse de protection.

Caractéristiques	Pesage, tarage, totalisation. Sortie RS232 pour PC ou imprimante.	
Alimentation	230V / Batterie 6V - Autonomie de 70 h à pleine charge	
Affichage	LCD rétro-éclairé de 2 cm, bleu.	
T° d'utilisation	+10° à +40°C	
Portée	30 kg	
Précision	1 g	
Plateau inox (L. x l.)	30 x 23 cm amovible	
Poids	4 kg	
Référence	68222P E	
P.U.H.T	287,00 €	

### Balance Ambiance humide



Caractéristiques	Pesage, tarage	
Alimentation	220V / Batterie 6V 500 m A - Autonomie de 30 h à pleine charge	
Affichage	Double affichage arrière/avant par diode rouge de H. 1,8 cm	
T° d'utilisation	+ 5° à + 40°C	
Portée	6 kg	15 kg
Précision	0,5 g	1 g
Plateau inox (L. x l.)	22 x 19 cm amovible	
Poids	3,6 kg	
Référence	62667P E	62668P E
P.U.H.T	255,00 €	255,00 €

## BALANCES D'APPOINT



### Balance double affichage



Cette balance offre 4 fonctions essentielles : mise à zéro, tare, changement d'unité (g, lb, oz, s) et comptage des pièces (touche PCS) qui permet après enregistrement du poids d'une unité, de calculer le nombre d'unité présente lors de la pesée. Pochette de stockage latérale pour le chargeur. Environnement de fonctionnement : -10°+ 40°C. Environnement de stockage : -25°+ 50°C.

Portée	10 kg
Précision	2 à 10 g
Plateau inox (L. x l.)	18,5 x 18 cm
Alimentation	3 piles LR20 de 1,5V ou chargeur DC9V 300mA (fourni)
Affichage	Douche affichage LCD avant / arrière
Ambiance	Sèche
Référence	✓ 1001606P E
P.U.H.T	83,00 €

### Mini balance



Pour tous les pesages usuels en cuisine. Bouton de tare permettant de réaliser plusieurs pesées successives dans le même support.

Portée	5 kg
Précision	1 g
Plateau inox	Ø 20 cm
Alimentation	Chargeur DC9V 300mA ou 3 piles LR20 de 1,5V V
Référence	✓ 55790
P.U.H.T	49,50 €

### Balance Xtra plate



Balance extra plate dotée d'un plateau inox équipée d'un capteur de pression de haute précision. Affichage LED rétroéclairé. Tare automatique. Fonction arrêt automatique. Indicateur de batterie faible. Fonction mémoire.

Portée	5 kg
Précision	1 g
Plateau inox (L. x l.)	18 x 13,5 cm
Alimentation	1 pile cr2032 (fournie)
Dimensions hors tout (L x l x H)	22 x 15 x 1 cm
Référence	✓ 1006790P E
P.U.H.T	36,75 €

### Balance Tradition 500



Un écran large et facile à lire. Balance idéale pour des pesages occasionnels en zone sèche.

Portée	5 kg
Précision	20 g
Alimentation	Mécanique
Ambiance	Sèche
Poids	2,1 kg
Dimensions hors tout (L x l x H)	23,5 x 21 x 25,5 cm
Référence	65002P E
P.U.H.T	37,50 €



## THERMOMÈTRES À PIQUER

-20° à +50°C



### Thermomètre Testo

Livré avec étui de protection top safe et clip de fixation. Avec sonde de pénétration Ø 2,4 x L. 16 cm. IP67. Précision +/- 1°C. Maxi t° + 50°C. Mini t° - 20°C. Autonomie : 350 h. Dimensions : 22 x 3,5 x 5 cm.

61373 E -20 à +50°C

x1 P.U.HT  
87,00 €

-50° à +300°C



### Thermomètre à sonde amovible

Sonde L.16,5 x Ø 0,35 cm. Câble 120 cm. Alarme, fonction maxi/mini. Protection anti-chocs, livré avec sonde Thermistor amovible noire en valise. Certificat de précision garantie. Précision +/- 0,5° de -20° à +100°C +/- 1°C de +100 à +150°C (sinon +/- 2°C). Compatible avec induction.

1011466P -50 à +300°C

x1 P.U.HT  
88,50 €

-50° à +200°C  
Passe au  
lave-vaisselle

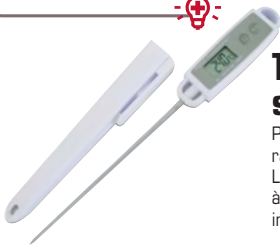

### Thermomètre stylo étanche

Passe au lave vaisselle. Temps de réponse rapide. Sonde L.12,5 x Ø 0,25 cm. Pile 1,5V LR44 fournie. IP 67. Précision +/- 1° de -20° à +120°C (sinon +/- 2°C). Compatible avec induction.

1011463P -50 à +200°C

x1 P.U.HT  
31,75 €

-50° à +200°C



### Thermomètre stylo en T étanche

Sonde L. 12,5 x Ø 0,5 cm. Pile 1,5V LR44 fournie. IP 65. Précision +/- 1° de -20° à +120°C (sinon +/- 2°C). Compatible avec induction.

1011465P -50 à +200°C

x1 P.U.HT  
24,75 €

-50° à +200°C



### Thermomètre stylo étanche

Sonde L.12,5 x Ø 0,35 cm. Pile 1,5V LR44 fournie. IP 65. Précision +/- 1° de 0° à +100°C (sinon +/- 3°C).

1011462P E -50 à +200°C

x1 P.U.HT  
16,00 €

## THERMOMÈTRES FOUR ET CONFISEUR

0° à +300°C



### Thermomètre four avec sonde



Sonde L.15 x Ø 0,4 cm. 2 piles 1,5V AAA fournies. Timer 23 H-59 mn-59 s. Horloge. Aimant. Alarme programmable. Dos inclinable. Précision +/- 1° de 0° à +150°C (sinon +/- 3°C). Câble-étanche 100 cm. Compatible induction.

1011470P E 0 à +300°C

x1 P.U.HT  
38,00 €

-50° à +300°C



### Thermomètre four avec sonde courbée



Sonde L.18 x Ø 0,4 cm. 2 piles 1,5V AAA fournies. Alarme de température. Minuteur 99 mn-59 s. Dos aimanté. Câble 100 cm.

1011469P -50 à +300°C

x1 P.U.HT  
21,50 €

+80° à +200°C

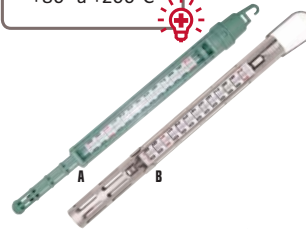

### Thermomètre confiseur



Spécialement étudié pour le contrôle des températures en confiserie. Liquide rouge. Stérilisable.

A 1011471P Gaine nylon x1  
B 1011472P Gaine inox x1

P.U.HT  
10,90 €  
24,75 €

## THERMOMÈTRES INFRAROUGE

-55° à +330°C



### Flashfood Duo étanche



Alimentation 2 piles AAA, 1,5 V (fournies). L. 16 x l. 3,8 cm. Précision +/- 1,5° < 65°C +/- 1,5° > 65°C.

56795P

x1 P.U.HT  
223,00 €

-55° à +350°C



### Flashfood Solo



Alimentation 2 piles AAA, 1,5V (fournies). L. 12,6 x l. 4,5 cm. Précision +/- 2°.

56794P

x1 P.U.HT  
141,00 €

-40° à +280°C



### Eco avec sonde



Infrarouge : -40 +280°C, sonde -40 +200°C. Sonde robuste, L. 8 cm, rotative 180°. Minuteur. Rétro éclairage Maxima, data Hold. Alimentation 1 pile 9V JEC GF22 fournie. Précision +/- 1° C.

1011474P

x1 P.U.HT  
143,00 €

## 1<sup>er</sup> PRIX

-50° à +380°C



### Eco



Visée laser. Rétro éclairage data Hold. Alimentation 2 piles 1,5V AAA fournies. Précision +/- 2° C. Livré avec sacoche.

1011473P E -50 à +380°C

x1 P.U.HT  
62,00 €

## THERMOMÈTRES RÉFRIGÉRATEUR / CONGÉLATEUR



Double sonde  
-40° à +70°C

### Thermomètre frigo



Thermomètre frigo/congérateur digital  
Fonction Max/Min, Int/Ext. Timer pour décompte du temps de dépassement. Double écran. Double alarme programmable (sonore et lumineuse). Double câble 100 cm. Double sonde. Aimant.

**1011468P** L. 14 cm x 1 **P.U.HT 25,25 €**

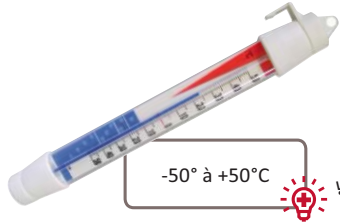

-50° à +50°C

### Thermomètre frigo/congérateur



En plastique. Avec crochet. Double sonde. Aimant.

**1011467P** E L. 20 cm x 1 **P.U.HT 2,80 €**

## THERMALIM



Thermalim II Réfrigéré  
-35° à +15°C

### Thermalim



Surveille la température de l'air dans les locaux d'entreposage et de stockage de plus de 10 m<sup>3</sup> destinés à recevoir des denrées surgelées, congelées ou réfrigérées. Obligatoire par la norme NF E18-150 et la démarche HACCP. Les données s'inscrivent sur les diagrammes circulaires : étendue de mesure et échelle du temps (durée 7 jours). Mouvement à quartz alimenté par pile LR6, 1,5V (fournie). Capteur : bulbe en acier inox Ø 1 cm et de longueur 10 cm relié au boîtier par un capillaire. Protection IP20. Ø 3 mm en cuivre 3 m. Dimensions : 14,4 x 14,4 x ép. 12,5 cm. Livrés avec 100 diagrammes, 1 stylo, 1 jeu de clés, 1 bride.

Enregistreur Thermalim II réfrigéré  
**42479** E (-35° à +15°C) x 1 **P.U.HT 480,00 €**

Disques diagrammes réfrigérés  
**42531P** E Paquet de 100 x 1 **P.U.HT 56,00 €**

Enregistreur Thermalim II surgelé  
**69282** E (+15° à -35° C) x 1 **P.U.HT 474,00 €**

Disques diagrammes surgelés  
**69281P** E Paquet de 100 x 1 **P.U.HT 56,00 €**

Stylo fibrodian  
**49055P** E Paquet de 5 x 1 **P.U.HT 65,00 €**

Thermalim II Surgelé  
+15° à -35°C

## ENREGISTREURS DE TEMPÉRATURE



-35° à +80°C

### Enregistreur de température USB Data Logger



Étanche IP66. Résolution : 0,1°C. Précision thermomètre : +/- 0,3°C. Précision hygromètre : +/- 3% RH. Capacité de mémoire : 32000 lectures. Intervalle des points de 10 sec à 12 H. Interface USB. Alarme visuelle. Résultats en format txt, xls, csv, bmp, jpg. CD-rom fourni avec logiciel DGraphTM et pilote USB. Durée de la pile +/- 3 ans.

Température  
**1011478** -35 à +80°C x 1 **P.U.HT 108,00 €**



-40° à +125°C

Température avec sonde à piquer  
**1011479** -40 à +125°C x 1 **P.U.HT 129,00 €**



-35° à +80°C

Température et humidité  
**1011476** -35 à +80°C, 0 à 100% RH x 1 **P.U.HT 129,00 €**



-40° à +100°C

Température et humidité avec sonde non percante  
**1011477** E -40 à +100°C, 0 à 100% RH x 1 **P.U.HT 135,00 €**

## MINUTEUR

nouveau !



### Chronomètre minuteur



Fonctions : minuteur et chronomètre : 99 mn - 59 s Écran tactile 9 cm. Son 80 Db. Aimant au dos ou à poser. 2 piles AAA.

**1013425P** Ø 8,4 x 2,5 cm x 1 **P.U.HT 13,80 €**

Ne pas utiliser à l'intérieur d'un four ou d'un micro-ondes.  
Ne pas laver au lave-vaisselle.



### Minuteur



En plastique. Minuteur et chronomètre 19 H / 59 mn. Son 8 dB. Aimanté ou à poser.

**1011475P** E L. 7 x l. 7 cm x 1 **P.U.HT 9,40 €**



Le prélèvement, une étape obligatoire. En restauration commerciale comme en restauration collective, il est obligatoire de conserver des plats témoins à la disposition exclusive des services officiels de contrôle. Ces plats témoins sont des échantillons représentatifs des différents plats distribués aux consommateurs. Ils doivent être clairement identifiés, prélevés en quantité suffisante pour permettre leur analyse microbiologique et chimique si nécessaire. Ils doivent être conservés pendant au moins cinq jours après la dernière présentation au consommateur, dans des conditions non susceptibles de modifier leur qualité microbiologique.

Prélever des échantillons de chaque plat fourni aux consommateurs, dans les sacs et les godets prévus à cet effet. Les stocker dans le bloc clear composé de 2 tiroirs.

Étiqueteuse en ABS pour une grande résistance à la corrosion. Facile d'utilisation : changement rapide grâce à un chemin papier rectiligne. Entretien simple : accès libre sur tout le trajet des étiquettes. Ligne de 8 caractères chiffrés sur étiqueteuse 2 lignes. Cartouche d'encre incluse. 1 tampon est fourni dans chaque sachet d'étiquettes.

Vous pouvez ainsi composer votre propre concept de prélèvements, avec autant de blocs de 2 tiroirs que vous voulez !



## Lot de 5 bacs plats témoins



Polyéthylène haute densité. Gamme spécifique destinée à faciliter la conservation des échantillons de plats.

Dim. ext. L. 34,7 x l. 24 x H. 7 cm  
Dim. int. L. 31,5 x l. 20 x H. 7 cm

Lot de 5 bacs de 3 L  
**65401** E x 1 **P.U.HT 37,50 €**

Carton de 1000 sacs prélèvement  
**65402** E L. 22 x l. 16 cm x 1 **95,50 €**



## Godet repas témoin



En PS. Contenance 10 cl. Vendu sans couvercle.

Pot - Sachet de 100  
**1001763P** Ø 7,3 x H. 4,9 cm x 10 **P.U.HT 3,70 €**

Couvercle - Sachet de 100  
**1001764P** Ø 7,5 cm x 10 **3,00 €**

## Sac congélation / prélèvement

En polyéthylène transparent.



Code	Description	Quantité	P.U.HT
<b>49051P</b>	E Boîte de 300 - L. 36 x l. 24 cm	x 1	<b>20,75 €</b>
<b>49052P</b>	Boîte de 200 - L. 45 x l. 30 cm	x 1	<b>21,25 €</b>
<b>1013100P</b>	Paquet de 100 - L. 45 x l. 30 cm	x 10	<b>7,00 €</b>
<b>49053P</b>	Boîte de 150 - L. 50 x l. 35 cm	x 1	<b>18,25 €</b>

## Étiquette repas témoin



Autocollante.

Sachet de 2500  
**1002100** 8,9 x 3,6 cm x 1 **P.U.HT 54,50 €**



## Étiquette biodégradable



Se dissout complètement dans l'eau en 30 secondes, ne laisse aucun résidu. -40°C à 93°C pendant 4 heures. Compatible avec les micro-ondes.



Étiquettes dissolubles et biodégradables



Rouleau de 250 étiquettes  
**50703P** E L. 7,6 x l. 5 cm x 1 **P.U.HT 41,25 €**

## Sac échantillonnage plats témoins



Sacs stériles (irradiés à 10 KGray) en polyéthylène basse densité. Fermeture à zip, surface d'inscription : 17 x 24 cm.

Boîte de 1000  
**53520P** E L. 25 x l. 18 cm x 1 **P.U.HT 203,00 €**



## Note de traçabilité alimentaire



Étiquette repositionnable. Spécial chambre froide : ne se décolle pas avec l'humidité et résiste à une forte ventilation grâce à un encollage sur toute la surface.

Produit : .....  
Date de fabrication : .....  
DLC interne : .....  
Réalisé par : .....

6 blocs de 50 étiquettes  
**56453P** E 10 x 4 cm x 1 **P.U.HT 14,30 €**

## Organisateur bleu Clear Box



Bloc 2 tiroirs en polypropylène et armature polystyrène. Livré sans étiquettes. Pour 4 jours de prélèvement, prévoir 2 blocs. Emboîtable.

**49337P** E L. 40 x l. 39,5 x H. 14 cm x 3 **P.U.HT 27,75 €**

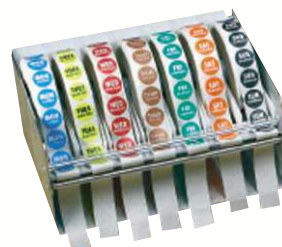

## Kit 7 jours



Dévidoir contenant 7 bobines d'étiquettes : 1 couleur pour chaque jour de la semaine pour repérer facilement, le produit à consommer. Trilingue : français, anglais et espagnol. Utilisable de -40°C à +70°C.

**54144P** Dévidoir seul x 1 **P.U.HT 171,00 €**  
**54146P** Boîte de 7 x 1000 étiquettes x 1 **44,25 €**





## Etiqueteuse 1 et 2 lignes

A.C.C.P.

Etiqueteuse en ABS pour une grande résistance à la corrosion. Facile d'utilisation : chargement rapide grâce à un chemin papier rectiligne. Entretien simple : accès libre sur tout le trajet des étiquettes. Ligne de 8 caractères chiffrés. Cartouche d'encre incluse. Un tampon est fourni dans chaque sachet d'étiquette.

Etiqueteuse			P.U.HT
54151P	1 ligne	x 1	80,50 €
54150P	2 lignes	x 1	137,00 €
Etiquette			
54149P	Neutre 1 ligne avec tampon sachet de 20000	x 1	28,25 €
54148P	Neutre 2 lignes avec tampon sachet de 14000	x 1	28,50 €
54145P	"Fabriqué le. A consommer le" - sachet de 14000 pour étiqueteuse 2 lignes	x 1	29,25 €

nouveau !

## Etiqueteuse 2 lignes

A.C.C.P.

Pack étiqueteuse + 4 rouleaux de 1200 étiquettes blanches 26 x 16 mm + 1 encrreur. 1ère ligne avec au choix 13 textes : Cuisiné le, Fabriqué le, Congelé le, Décongelé le, Ouvert le, Emballé le, Livré le, Numéro de lot, A Cons. jusqu'au, A Cons. de préf avant le, Nettoyé le, °C de Stockage, Prix au Kg. 2nde ligne : Jour - Mois - Année



			P.U.HT
1013752P	L. 33 x l. 21 x H. 6,5 cm	x 1	135,00 €
1013753P	Neutre 2 lignes Sachet de 12000	x 1	24,00 €

## Etuve incubateur

A.C.C.P.

Etuve 4 litres pour incubation préréglée à 37°C. Conçue spécialement pour obtenir une température homogène avec possibilité de réglage jusqu'à + 5°C en fonction de l'ambiance. Livrée avec portoir 23 lames et thermomètre.



			P.U.HT
127439	E	x 1	360,00 €

## Lames gélosées

A.C.C.P.

2 faces. Face verte : détection des bactéries pathogènes ; permet de diagnostiquer une contamination. Face jaune : détection de la flore totale.

Mode d'emploi :

1. Appliquer la lame gélosée 10 secondes sur la surface à tester en appuyant fortement sur chaque face.
2. Placer la lame dans l'étuve à 37°C pendant 24h.
3. Lecture des résultats. Fréquence d'utilisation recommandée minimum 1 fois par semaine sur 1 main + 1 vêtement + 2 surfaces. DLC 6 mois.

Pack 20 lames			P.U.HT
67259	E	x 1	39,00 €



nouveau !



## Écouvillon protéines

A.C.C.P.

Une solution rapide et fiable pour tester l'état de propreté des surfaces ! Rapide : lecture visuelle en 10 minutes. Sûr et facile : peu de manipulation. Fiable et sensible : détection de quelques µg de protéines ou de sucre réducteurs. Pratique : stockage à 20°C.

Paquet de 10			P.U.HT
1013381		x 1	58,00 €



Écouvillonnage sur une surface de 10x10 cm



Introduire l'écouvillon dans le tube et mélanger

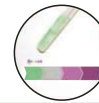

Après 10 mn comparer la couleur obtenue avec le tableau de référence fourni



## Kit allergènes

VOLLRATH

A.C.C.P.

Idéal pour préparer les plats sans allergènes grâce à son code couleur le violet. Composé de 9 ustensiles de cuisine :

- un bac et son couvercle,
- un fouet 30,5 cm,
- une pince 24,1 cm,
- une louche 6 cl,
- une planche à découper 45,7 x 30,5 cm,
- une poêle anti-adhésive 25,4 cm,
- une spatule 21 x 7,3 cm,
- une cuillère de service 35,1 cm.

			P.U.HT
1008164	E L. 50,8 x l. 38,1 x H. 17,8 cm	x 1	131,00 €



## Testeur d'huile

A.C.C.P.

Appareil de mesure à main utilisé pour déterminer la qualité et la température des huiles de friture. Peut être utilisé directement dans la friteuse. Extrêmement rapide : fournit des résultats de mesure en 20 secondes. Livré avec une mallette.

			P.U.HT
1008007P	E L. 35,4 x l. 5 x H. 3 cm.	x 1	501,00 €



Résultat en moins de 20 secondes



## Testeur d'huile

A.C.C.P.

Idéal pour contrôler la qualité des huiles en restauration.

Boite de 10 tests + 1 pipette			P.U.HT
1007639P	E	x 1	31,25 €



Résultat en moins de 3 minutes





pro.cooker



## **Votre allié dans la cuisine**

Dédiée à la cuisine, la marque Pro.Cooker vous garantit la qualité professionnelle au meilleurs prix. Découvrez notre sélection de produits indispensables : couteaux, batteries, matériel électrique, moules, planches à découper, toile de cuisson...

## Priority

Batterie de cuisine professionnelle innovante en amalgame d'acier inoxydable multi-couches, hyper conducteur. Queue tube ergonomique froide rivetée en inox.

de Buyer  
DEPUIS 1830



### Premium



Casserole			P.U. HT
50195P	Ø 14 x H. 8 cm - 1,2 L	x 1	67,00 €
50196	Ø 16 x H. 9 cm - 1,8 L	x 1	75,50 €
50197P	Ø 18 x H. 10 cm - 2,5 L	x 1	88,00 €
50198P	Ø 20 x H. 11 cm - 3,4 L	x 1	104,00 €
50199P	Ø 24 x H. 13 cm - 5,8 L	x 1	131,00 €
50200	Ø 28 x H. 15 cm - 9,2 L avec poignée	x 1	173,00 €



Sauteuse droite			P.U. HT
50201P	Ø 24 x H. 7 cm - 3 L	x 1	110,00 €
50202	Ø 28 x H. 7,5 cm - 4,6 L avec poignée	x 1	137,00 €



Sauteuse bombée			P.U. HT
50203	Ø 16 x H. 6,5 cm - 1 L	x 1	67,00 €
50204P	Ø 20 x H. 7 cm - 1,7 L	x 1	87,50 €
50205P	Ø 24 x H. 8 cm - 3 L	x 1	124,00 €



Sautoir avec couvercle			P.U. HT
50206	Ø 24 x H. 7 cm - 3 L	x 1	149,00 €
50207	Ø 28 x H. 7,5 cm - 4,6 L	x 1	165,00 €



Faitout avec couvercle			P.U. HT
50209	Ø 20 x H. 11 cm - 3,4 L	x 1	135,00 €
50210	Ø 24 x H. 13 cm - 5,8 L	x 1	152,00 €
50211	Ø 28 x H. 15 cm - 9,2 L	x 1	203,00 €



Couvercle			P.U. HT
50216	Ø 14 cm	x 1	6,90 €
50217	Ø 16 cm	x 1	9,00 €
50219	Ø 20 cm	x 1	12,00 €
50220	Ø 24 cm	x 1	15,50 €
50221	Ø 28 cm	x 1	19,50 €
50222	Ø 32 cm	x 1	30,50 €



## PRIORITY

nouveau !

### M'Urban

En inox brossé.

MAUVIEL 1830.



Casserole			P.U. HT
1013447	Ø 14 x H. 8 cm - 1,1 L	x 1	58,00 €
1013448	Ø 16 x H. 9 cm - 1,8 L	x 1	70,00 €
1013449	Ø 18 x H. 10 cm - 2,5 L	x 1	76,00 €



Sauteuse droite			P.U. HT
1013450	Ø 24 x H. 7,5 cm - 3,1 L	x 1	108,00 €



Poêle ronde			P.U. HT
1013451	Ø 20 x H. 4 cm	x 1	70,00 €
1013452	Ø 26 x H. 4,9 cm	x 1	87,50 €
1013453	Ø 30 x H. 5 cm	x 1	98,00 €



Revêtement Eclipse+

Poêle ronde anti-adhésive			P.U. HT
1013455	Ø 20 x H. 4 cm	x 1	84,00 €
1013456	Ø 26 x H. 4,9 cm	x 1	103,00 €
1013457	Ø 30 x H. 5 cm	x 1	112,00 €



Cocotte avec couvercle en verre			P.U. HT
1013454	Ø 24 x 12 cm - 5,2 L	x 1	128,00 €

PRIORITY / M'URBAN



CUISINE



## Qualiplus

En acier inoxydable offrant une excellente résistance à la corrosion et aux acides alimentaires.

Fond capsulé (inox - aluminium - inox) permettant une diffusion optimale de la chaleur. Finition intérieure et extérieure poli satinée, avec une collerette poli miroir.

L'intérieur de chaque pièce est jaugée pour une meilleure précision.

Bord verseur.

Queues athermiques en tube inox (casserole et sauteuses) et montures (sautoirs, marmites et faitouts) en inox soudées très résistantes.

Couvercles empilables et faciles à ranger.

Entretien aisé grâce aux angles arrondis.

Tests et essais réalisés en laboratoires et conformes à la norme NF EN12983-1.



Ø 28 cm avec poignée



Anses renforcées



### Casserole

			P.U.HT
<b>70511P</b>	Ø 12 x H. 7 cm - 0,7 L	x 1	<b>32,75 €</b>
<b>70512P</b>	Ø 14 x H. 7,5 cm - 1,1 L	x 1	<b>38,50 €</b>
<b>70510P</b>	Ø 16 x H. 8 cm - 1,6 L	x 1	<b>41,00 €</b>
<b>70509P</b>	Ø 18 x H. 9 cm - 2,2 L	x 1	<b>43,00 €</b>
<b>70508P</b>	Ø 20 x H. 10 cm - 3,1 L	x 1	<b>51,50 €</b>
<b>70507P</b>	Ø 24 x H. 12 cm - 5,4 L	x 1	<b>65,00 €</b>
<b>70506P</b>	Ø 28 x H. 14 cm - 8,6 L avec poignée	x 1	<b>85,00 €</b>

### Sauteuse droite

			P.U.HT
<b>70530P</b>	Ø 24 x H. 8 cm - 3,6 L	x 1	<b>58,00 €</b>
<b>70529P</b>	Ø 28 x H. 9 cm - 5,5 L	x 1	<b>73,50 €</b>
<b>70528P</b>	Ø 32 x H. 10,5 cm - 8,4 L	x 1	<b>99,00 €</b>

### Sauteuse conique

			P.U.HT
<b>70533P</b>	Ø 16 x H. 6 cm - 1,2 L	x 1	<b>43,25 €</b>
<b>70532P</b>	Ø 20 x H. 7 cm - 2,2 L	x 1	<b>53,50 €</b>
<b>70531P</b>	Ø 24 x H. 8 cm - 3,6 L	x 1	<b>65,50 €</b>

### Sautoir

			P.U.HT
<b>70517P</b>	Ø 28 x H. 11 cm - 6,7 L	x 1	<b>83,00 €</b>
<b>70516P</b>	Ø 32 x H. 12,5 cm - 10 L	x 1	<b>113,00 €</b>
<b>70515P</b>	Ø 36 x H. 14 cm - 14,2 L	x 1	<b>159,00 €</b>
<b>70514P</b>	Ø 40 x H. 15,5 cm - 19,4 L	x 1	<b>196,00 €</b>
<b>70513P</b>	Ø 45 x H. 17 cm - 27 L	x 1	<b>289,00 €</b>

### Faitout

			P.U.HT
<b>70505P</b>	Ø 28 x H. 17,5 cm - 10,7 L	x 1	<b>104,00 €</b>
<b>70504P</b>	Ø 32 x H. 19 cm - 15,2 L	x 1	<b>138,00 €</b>
<b>70503P</b>	Ø 36 x H. 21 cm - 21,3 L	x 1	<b>168,00 €</b>
<b>70502P</b>	Ø 40 x H. 25 cm - 31,4 L	x 1	<b>221,00 €</b>
<b>70501P</b>	Ø 45 x H. 28 cm - 44,5 L	x 1	<b>321,00 €</b>

### Marmite traiteur

			P.U.HT
<b>70523P</b>	Ø 24 x H. 24 cm - 10 L	x 1	<b>96,00 €</b>
<b>70522P</b>	Ø 28 x H. 28 cm - 17 L	x 1	<b>120,00 €</b>
<b>70521P</b>	Ø 32 x H. 32 cm - 25 L	x 1	<b>157,00 €</b>
<b>70520P</b>	Ø 36 x H. 36 cm - 36 L	x 1	<b>206,00 €</b>
<b>70519P</b>	Ø 40 x H. 40 cm - 50 L	x 1	<b>267,00 €</b>

## EcoPlus

En acier inoxydable.  
Fond diffuseur triple épaisseur.  
Queue athermique en tube inox.

Montures en acier inoxydable soudées très résistantes : tests et essais réalisés en laboratoire et conformes à la norme NF EN 1/2983-1.



### Casserole

			P.U. HT
	<b>67742P</b>	E Ø 12 x H. 6 cm - 0,7 L	x1 <b>20,50 €</b>
	<b>66596P</b>	E Ø 14 x H. 7,5 cm - 1,1 L	x1 <b>21,75 €</b>
	<b>67743P</b>	E Ø 16 x H. 8,5 cm - 1,7 L	x1 <b>22,75 €</b>
	<b>66597P</b>	E Ø 18 x H. 9,5 cm - 2,4 L	x1 <b>24,75 €</b>
	<b>66598P</b>	E Ø 20 x H. 10,5 cm - 3,3 L	x1 <b>28,00 €</b>
	<b>66600P</b>	E Ø 24 x H. 12 cm - 5,4 L	x1 <b>31,00 €</b>
	<b>66599P</b>	E Ø 28 x H. 14 cm - 8,5 L Avec poignée	x1 <b>44,75 €</b>



### Sautoir

			P.U. HT
	<b>66607P</b>	E Ø 28 x H. 14 cm - 8,5 L	x1 <b>47,50 €</b>
	<b>67746P</b>	E Ø 32 x H. 16 cm - 12,5 L	x1 <b>72,00 €</b>
	<b>66609P</b>	E Ø 36 x H. 18 cm - 18 L	x1 <b>79,50 €</b>
	<b>67747P</b>	E Ø 40 x H. 20 cm - 25 L	x1 <b>129,00 €</b>
	<b>66608P</b>	E Ø 45 x H. 22,5 cm - 35,5 L	x1 <b>163,00 €</b>



### Faitout

			P.U. HT
	<b>66604P</b>	E Ø 28 x H. 18,5 cm - 11 L	x1 <b>60,50 €</b>
	<b>67740P</b>	E Ø 32 x H. 21,5 cm - 17 L	x1 <b>108,00 €</b>
	<b>66605P</b>	E Ø 36 x H. 24 cm - 24 L	x1 <b>111,00 €</b>
	<b>67741P</b>	E Ø 40 x H. 30 cm - 33,5 L	x1 <b>169,00 €</b>
	<b>66606P</b>	E Ø 45 x H. 30 cm - 47,5 L	x1 <b>194,00 €</b>



### Marmite traiteur

			P.U. HT
	<b>67744P</b>	E Ø 24 x H. 24 cm - 10 L	x1 <b>50,50 €</b>
	<b>66601P</b>	E Ø 28 x H. 28 cm - 17 L	x1 <b>57,50 €</b>
	<b>67745P</b>	E Ø 32 x H. 32 cm - 25 L	x1 <b>99,00 €</b>
	<b>66602P</b>	E Ø 36 x H. 36 cm - 36 L	x1 <b>115,00 €</b>
	<b>66603P</b>	E Ø 40 x H. 40 cm - 50 L	x1 <b>154,00 €</b>
	<b>70518P</b>	E Ø 45 x H. 45 cm - 70 L	x1 <b>226,00 €</b>

## COMPATIBLES QUALIPLUS ET ECOPLUS



Empilable, rangement facilité

### Couvercle

			P.U. HT
	<b>70542P</b>	E Ø 16 cm	x1 <b>9,00 €</b>
	<b>70541P</b>	E Ø 18 cm	x1 <b>10,30 €</b>
	<b>70540P</b>	E Ø 20 cm	x1 <b>11,60 €</b>
	<b>70539P</b>	E Ø 24 cm	x1 <b>13,50 €</b>
	<b>70538P</b>	E Ø 28 cm	x1 <b>16,25 €</b>
	<b>70537P</b>	E Ø 32 cm	x1 <b>24,75 €</b>
	<b>70536P</b>	E Ø 36 cm	x1 <b>31,50 €</b>
	<b>70535P</b>	E Ø 40 cm	x1 <b>33,00 €</b>
	<b>70534P</b>	E Ø 45 cm	x1 <b>43,50 €</b>





## Choc Extrême



Gamme en fonte d'aluminium coulée sous pression, revêtue d'un anti-adhésif de qualité garanti sans PFOA, épaisseur de fond (7 mm).

Poêle ronde			P.U.HT
<b>1001016P</b>	Ø 20 x H. 4,5 cm	x 1	<b>47,00 €</b>
<b>1001015P</b>	Ø 24 x H. 4,5 cm	x 1	<b>58,50 €</b>
<b>1001014P</b>	Ø 28 x H. 4,5 cm	x 1	<b>73,50 €</b>
<b>1001013P</b>	Ø 32 x H. 4,5 cm	x 1	<b>80,00 €</b>



## Choc Resto Induction



Gamme professionnelle en aluminium. Anti-adhésive. Fond magnétique forgé spécial induction. Queue feuillard rivetée, courbure «à la française».

Poêle ronde			P.U.HT
<b>1007377P</b>	Ø 20 x H. 3 cm	x 1	<b>27,00 €</b>
<b>1007378P</b>	Ø 24 x H. 3,5 cm	x 1	<b>33,25 €</b>
<b>1007380P</b>	Ø 28 x H. 3,8 cm	x 1	<b>37,00 €</b>
<b>1007379P</b>	Ø 32 x H. 4,5 cm	x 1	<b>45,00 €</b>
<b>1011178P</b>	Ø 36 x H. 4,7 cm	x 1	<b>58,00 €</b>
Poêle à crêpe			P.U.HT
<b>1007376P</b>	Ø 26 cm	x 1	<b>31,00 €</b>

nouveau !



Pour poissons entiers 

Poêle ovale			P.U.HT
<b>1013433P</b>	L. 36 x l. 26 x H. 4,3 cm	x 1	<b>64,00 €</b>



## Minéral B



Le fer est un matériau minéral 100% naturel : garanti sans revêtement (ni PFOA, ni PTFE), pas de composants chimiques ajoutés. Finition à la cire d'abeille qui favorise le culottage et améliore l'anti-adhérence. Epaisseur 2,5 à 3 mm. Qualité lourde extra-forte.

Poêle ronde			P.U.HT
<b>70105P</b>	Ø 20 x H. 3,3 cm	x 1	<b>22,50 €</b>
<b>70106P</b>	Ø 24 x H. 3,9 cm	x 1	<b>26,25 €</b>
<b>70107P</b>	Ø 28 x H. 4 cm	x 1	<b>36,75 €</b>
<b>70108P</b>	Ø 32 x H. 4,2 cm	x 1	<b>41,25 €</b>

nouveau !



Plancha			P.U.HT
<b>1013434</b>	L. 36 x l. 26 x H. 2,5 cm	x 1	<b>50,50 €</b>

Poêles Minéral B, idéales pour SAISIR, DORER, GRILLER les aliments. Lorsque la poêle atteint des températures supérieures à 140°C, cela provoque la réaction de Maillard. Les aliments sont saisis en surface, permettant la caramélisation de leurs sucres naturels. Une croûte se forme, empêchant l'humidité de s'évaporer. Les aliments deviennent dorés et croustillants en surface, fondants et moelleux à l'intérieur. Bien préchauffer la poêle avant la cuisson. Une bonne poêle en tôle d'acier doit être culottée. Devenue noire après plusieurs utilisations, la cuisson se fait avec très peu de matière grasse. Pour lui conserver ses propriétés et éviter l'oxydation : laver la poêle à l'eau chaude sans produit vaisselle. L'essuyer immédiatement avec du papier absorbant. Huiler et stocker à l'abri de l'humidité. Culottage : mettre des épluchures de pommes de terre dans votre ustensile, couvrir d'eau, faire bouillir pendant 15 minutes. Ensuite, jeter les épluchures puis rincer l'ustensile à l'eau très chaude, essuyer et refaire chauffer un peu d'huile dans la poêle. Essuyer la poêle avec du papier absorbant. Elle est prête à être utilisée.





## Poêle Qualiplus



En acier inoxydable offrant une excellente résistance à la corrosion et aux acides alimentaires. Fond capsulé (inox - aluminium - inox) permettant une diffusion optimale de la chaleur. Revêtement anti-adhésif multicouches. Queue athermique en tube inox. Fixation 4 rivets très résistante.

		📦	P.U.HT
🛒 70527P	Ø 20 x H. 4,5 cm - 1,2 L	x 1	41,50 €
🛒 70526P	Ø 24 x H. 5,5 cm - 2 L	x 1	48,50 €
🛒 70525P	Ø 28 x H. 5,5 cm - 3 L	x 1	60,00 €
🛒 70524P	Ø 32 x H. 5,5 cm - 4 L	x 1	78,50 €



## Poêle Aluminium



Gamme de poêles professionnelles en aluminium épais (entre 3 et 5 mm) avec revêtement anti-adhésif multicouches. Queue feuillard rivetée extra résistante avec oeilleton d'accrochage. Excellente transmission et répartition de la chaleur. Idéale pour mijoter, réchauffer, réapproprié les plats pré-cuisinés. Ne doit jamais être surchauffée, ni être vide sur une source de chaleur.

		📦	P.U.HT
<b>Poêle ronde</b>			
🛒 70131P	E Ø 20 x H. 3,5 cm	x 1	16,75 €
🛒 70132P	E Ø 24 x H. 4 cm	x 1	18,75 €
🛒 70147P	E Ø 28 x H. 4,5 cm	x 1	21,90 €
🛒 70133P	E Ø 32 x H. 5,5 cm	x 1	27,50 €
🛒 70135P	E Ø 36 x H. 5,5 cm	x 1	35,75 €
🛒 70134P	E Ø 40 x H. 6 cm	x 1	41,75 €



		📦	P.U.HT
<b>Poêle ovale</b>			
🛒 70136P	E L. 36 x l. 25 x H. 5 cm	x 1	46,00 €
🛒 70137P	E L. 40 x l. 29 x H. 5 cm	x 1	57,00 €



		📦	P.U.HT
<b>Poêle rectangulaire</b>			
🛒 18336P	L. 38 x l. 26 x H. 4,2 cm	x 1	58,00 €



		📦	P.U.HT
<b>Poêle à crêpe</b>			
🛒 70129P	Ø 22 x H. 1,6 cm	x 1	16,25 €
🛒 70130P	Ø 26 x H. 1,6 cm	x 1	17,25 €



		📦	P.U.HT
<b>Poêle à blinis</b>			
🛒 70128P	Ø 12 x H. 2 cm	x 1	11,90 €

1<sup>er</sup> PRIX



## Lot de 3 poêles aluminium

Revêtement anti-adhésif double couche. Épaisseur 3 mm.



		📦	P.U.HT
🛒 67691P	E Ø 24, 28 et 32 cm	x 1	56,50 €



## Poêle wok



En aluminium épais avec revêtement anti-adhésif multicouches. Queue feuillard rivetée extra résistante avec oeilleton d'accrochage. Excellente transmission et répartition de la chaleur.

		📦	P.U.HT
🛒 70138P	Ø 30 x H. 7,5 cm - 4 L	x 1	41,75 €





**Lacor**



## **La bonne cuisine a une nouvelle image.**

De nos jours, le secteur de la cuisine et de la pâtisserie demande les ustensiles les plus modernes pour la préparation, la manipulation, la cuisson, le transport, la conservation et la distribution des aliments.

LACOR soigne les moindres détails et vous offre le matériel le plus performant pour les meilleures solutions.





### Plaque à rôtir MAUVIEL 1830.

Aluminium avec revêtement anti-adhésif, anses fixes.

**54179** L. 40 x l. 30 x H. 8 cm x 1 **P.U.HT 123,00 €**



### Plaque à rôtir MAUVIEL 1830.

En aluminium. Angles arrondis.

**Anses fixes** **P.U.HT**

**54585P** L. 35 x l. 25 x H. 7 cm x 1 **74,50 €**  
**54586P** L. 40 x l. 30 x H. 8 cm x 1 **84,50 €**  
**54588** L. 50 x l. 40 x H. 9 cm x 1 **102,00 €**  
**54589** L. 55 x l. 40 x H. 9 cm x 1 **104,00 €**



**Anses tombantes** **P.U.HT**

**54580** L. 40 x l. 30 x H. 7 cm x 1 **71,00 €**  
**54581** L. 45 x l. 35 x H. 7 cm x 1 **82,00 €**  
**54582** L. 50 x l. 40 x H. 9 cm x 1 **102,00 €**



### Poissonnière

Inox. Avec grille et couvercle. Anses fixes.



**45493** L. 40 x l. 19 x H. 11 cm x 1 **P.U.HT 75,50 €**  
**45494** L. 50 x l. 19 x H. 11 cm x 1 **83,00 €**  
**45495** L. 60 x l. 19 x H. 11 cm x 1 **109,00 €**



### Bain marie

En inox.

**1005075P** Ø 12 x H. 12 cm - 1,25 L x 1 **P.U.HT 26,25 €**  
**1005076P** Ø 14 x H. 14 cm - 2,5 L x 1 **34,75 €**



### Passoire à pâtes

Tout inox. Pour braisière Ø 36 cm.

**61538P** Ø 36 x H. 23 cm x 2 **P.U.HT 36,75 €**



### Autocuiseur



En acier inoxydable. Sécurité optimale ! L'autocuiseur est doté de 4 sécurités : une à l'ouverture, une à la fermeture et deux en cas de sur-pression. Intérieur mat & extérieur miroir. Panier inclus.

**51597P** Ø 24 x H. 21 cm - 10 L x 1 **P.U.HT 136,00 €**



### Bassine à friture bombée



Panier en fil étamé. Bassine en tôle d'acier.

**Bassine** **P.U.HT**  
**283** Ø 36 x H 10,5 cm - 8,8 L x 1 **30,25 €**  
**34798** Ø 40 x H 13,1 cm - 12,2 L x 1 **36,25 €**

**Panier fil étamé** **P.U.HT**  
**2549** Ø 32,6 x H. 9,3 cm x 1 **34,50 €**  
**35001** Ø 39 x H. 12,4 cm x 1 **42,25 €**

## SPÉCIAL PAËLLA



### Plat paëlla



En tôle d'acier.

**53246** Ø 26 cm - 2 portions x 10 **P.U.HT 5,90 €**  
**52504** Ø 30 cm - 4 portions x 10 **7,20 €**  
**52505** Ø 40 cm - 9 portions x 10 **11,20 €**  
**53247** Ø 46 cm - 12 portions x 5 **14,70 €**  
**281** Ø 50 cm - 14 portions x 1 **17,50 €**  
**282** Ø 60 cm - 19 portions x 1 **33,50 €**  
**38203** Ø 70 cm - 25 portions x 1 **59,00 €**  
**35009** Ø 80 cm - 40 portions x 1 **81,00 €**  
**38261** Ø 115 cm - 120 portions x 1 **326,00 €**  
**38262** Ø 130 cm - 200 portions x 1 **676,00 €**



### Réchaud diffuseur à gaz



Pour gaz Butane.

**38205** Ø 40 cm x 1 **P.U.HT 69,50 €**  
**38206** Ø 60 cm x 1 **128,00 €**  
**52506** Ø 70 cm x 1 **210,00 €**



### Pied pour réchaud plat paëlla



**38498** H. 70 cm x 1 **P.U.HT 41,00 €**





Autres coloris disponibles, nous consulter



cannelle



moutarde



basilic



grenadine



gris anthracite



## Cocotte fonte



En fonte émaillée. Bouton laiton ou nickelé adapté pour la cuisson au four.

### Ronde - Noire

Code	Dimensions	Capacité	Quantité	P.U. HT
42252	Ø 14 cm x H 11,6 cm	0,80 L	x1	106,00 €
42253	Ø 16 cm x H 10 cm	1,4 L	x1	137,00 €
42254P	Ø 20 x H 14,2 cm	2,24 L	x1	154,00 €
42255	Ø 22 x H 14,7 cm	2,6 L	x1	175,00 €
42257P	Ø 26 x H 16,7 cm	5 L	x1	188,00 €
42258P	Ø 28 x H 18,2 cm	6,7 L	x1	240,00 €

### Ovale - Noire

Code	Dimensions	Capacité	Quantité	P.U. HT
42260	L 17 x l. 15 x H. 11,6 cm	1 L	x1	149,00 €
42261	L 23 x l. 22,5 x H. 14,1 cm	2,35 L	x1	173,00 €
42262	L 29 x l. 26 x H. 15,4 cm	4,25 L	x1	206,00 €
42263P	L 31 x l. 28 x H. 16,7 cm	5,5 L	x1	257,00 €
42264	L 33 x l. 30 x H. 17,3 cm	6,7 L	x1	240,00 €
42265P	L 37 x l. 33 x H. 18 cm	8 L	x1	295,00 €
53692	L 41 x l. 37 x H. 19,8 cm	12 L	x1	361,00 €

### Ronde - Cerise

Code	Dimensions	Capacité	Quantité	P.U. HT
1013489	Ø 20 x H. 14,5 cm	2,2 L	x1	158,00 €
1013491	Ø 28 x H. 18,2 cm	6,7 L	x1	222,00 €

### Ovale - Cerise

Code	Dimensions	Capacité	Quantité	P.U. HT
1013493	L 31 x l. 28 cm	5,5 L	x1	221,00 €

### Ronde - Bleue

Code	Dimensions	Capacité	Quantité	P.U. HT
1013490	Ø 28 x H. 18,2 cm	6,7 L	x1	222,00 €

### Ovale - Bleue

Code	Dimensions	Capacité	Quantité	P.U. HT
1013492	L 31 x l. 28 cm	5,5 L	x1	221,00 €

La fonte émaillée est un alliage de fer riche en carbone et recouverte d'émail principalement composé de verre. C'est un des matériaux qui retient le mieux la chaleur, la diffuse lentement et la répartit de façon parfaitement homogène, et ce, sur tous les types de feux, y compris l'induction. La fonte émaillée retient également le froid : pour cela, il suffit de placer vos préparations au réfrigérateur avant de servir.

### Mini cocotte ronde

Ø 10 x H. 7 cm - 25 cl

Code	Coloris	Quantité	P.U. HT
50725	Noire	x1	47,75 €
1013487	Bleue	x1	47,75 €
1013488	Cerise	x1	47,75 €

nouveau !



Mini cocotte noire " La coquette "  
Ø 12 x H. 10 cm - 40 cl - Lot de 3

Code	Coloris	Quantité	P.U. HT
1013494	Noire	x1	175,00 €

## Sauteuse Chistera



En fonte émaillée.

Les performances d'arrosage de ce couvercle bombé sont comparables à celles de la fameuse cocotte Staub avec son couvercle plat doté de picots.



Ø 24 x H. 11,6 cm - 2,4 L

Code	Coloris	Quantité	P.U. HT
1006330	Cerise	x1	147,00 €
1006331	Gris graphite	x1	147,00 €
1006332	Noire	x1	147,00 €

Ø 28 x H. 12,6 cm - 3,7 L

Code	Coloris	Quantité	P.U. HT
1006333	Cerise	x1	154,00 €
1006335	Gris graphite	x1	154,00 €
1006334	Noire	x1	154,00 €



## Mini cocotte

En fonte émaillée. Bouton laiton ou nickelé adapté pour la cuisson au four.



Set de 6 mini cocottes  
**1005612P** Ø 10 x H. 7 cm - 0,25 L

**P.U. HT**  
 x 1 **180,00 €**

**1<sup>er</sup> PRIX**



## Cocotte Cooko

En fonte émaillée.



Cocotte ronde  
**69729P** Ø 10 x H. 4,8 cm - 0,25 L  
**70268P** Ø 14 x H. 6,5 cm - 0,75 L

**P.U. HT**  
 x 1 **20,50 €**  
 x 1 **30,75 €**

Cocotte ovale  
**69730P** L. 12 x H. 4,8 cm - 0,30 L  
**70270P** L. 17 x H. 6,5 cm - 0,75 L

**P.U. HT**  
 x 1 **20,75 €**  
 x 1 **33,25 €**

**nouveau !**



## Cocotte

En fonte d'aluminium avec revêtement anti-adhésif. Jusqu'à 300° C.



Cocotte ronde  
**1012447P** Ø 14 x H. 7,5 cm - 0,9 L

**P.U. HT**  
 x 1 **25,00 €**

## PLATS EN FONTE



## Plat à paëlla

En fonte.

**1006327** Ø 34 cm - 4,3 L



**P.U. HT**  
 x 1 **127,00 €**



## Plat ovale

En fonte.

**45514** L. 24 cm  
**45515P** L. 28 cm  
**45516** L. 32 cm



**P.U. HT**  
 x 1 **60,50 €**  
 x 1 **77,00 €**  
 x 1 **85,00 €**



## Plat

En fonte.

Plat rond  
**70304P** Ø 20 cm

**P.U. HT**  
 x 1 **42,50 €**

Plat ovale  
**70303P** L. 21 x l. 15 cm

**P.U. HT**  
 x 1 **36,75 €**



## Plancha

En fonte. Utilisable des deux côtés. S'adapte facilement sur 2 plaques de cuisson à la fois.



**69723P** L. 42 x l. 23 cm

**P.U. HT**  
 x 1 **82,00 €**





**Coins renforcés en forme bec :**  
les liquides se versent facilement.



**Cales d'empilages :** les bacs ne se bloquent plus, se séparent facilement, sèchent plus rapidement.



Les capacités sont gravées au dos des récipients.



**Bords parfaitement plats :** plus rigides, ils assurent une fermeture hermétique.



**Choisir son bac :**

<b>GN 2/1</b>	65 x 53 cm
<b>GN 1/1</b>	53 x 32,5 cm
<b>GN 2/4</b>	53 x 16,2 cm
<b>GN 2/3</b>	35,3 x 32,5 cm
<b>GN 1/2</b>	32,5 x 26,5 cm

<b>GN 1/3</b>	32,5 x 17,6 cm
<b>GN 1/4</b>	26,5 x 16,2 cm
<b>GN 1/6</b>	17,6 x 16,2 cm
<b>GN 1/9</b>	17,6 x 10,8 cm



**Bac inox SP3**



**A - Couvercle avec poignée**



**B - Couvercle sans poignée**



**GN 2/4 (53 x 16,2 cm)**

	Cont.		P.U.HT
<b>49482</b>	Prof. 6,5 cm	3,1 L x 1	<b>28,25 €</b>
<b>49481</b>	Prof. 10 cm	5,7 L x 1	<b>39,50 €</b>
<b>49480</b>	Prof. 15 cm	8,2 L x 1	<b>69,00 €</b>
<b>49490</b>	A - Couvercle avec poignée	x 1	<b>19,25 €</b>



**GN 1/1 (53 x 32,5 cm)**

	Cont.		P.U.HT
<b>49449P</b>	Prof. 2 cm	- x 1	<b>19,75 €</b>
<b>49448P</b>	Prof. 4 cm	5,4 L x 1	<b>23,25 €</b>
<b>49447P</b>	Prof. 5,5 cm	7,3 L x 1	<b>22,00 €</b>
<b>49446P</b>	E Prof. 6,5 cm	8,5 L x 1	<b>23,00 €</b>
<b>49445P</b>	E Prof. 10 cm	13,4 L x 1	<b>27,75 €</b>
<b>49444P</b>	E Prof. 15 cm	19,9 L x 1	<b>41,50 €</b>
<b>49443P</b>	Prof. 20 cm	26,1 L x 1	<b>75,50 €</b>
<b>49485P</b>	A - Couvercle avec poignée	x 1	<b>20,00 €</b>
<b>49492P</b>	B - Couvercle sans poignée	x 1	<b>18,75 €</b>



**GN 1/3 (32,5 x 17,6 cm)**

	Cont.		P.U.HT
<b>49467</b>	Prof. 2 cm	- x 1	<b>13,70 €</b>
<b>49466P</b>	Prof. 4 cm	1,6 L x 1	<b>17,00 €</b>
<b>49465P</b>	Prof. 6,5 cm	2,4 L x 1	<b>16,00 €</b>
<b>49464P</b>	Prof. 10 cm	3,7 L x 1	<b>20,75 €</b>
<b>49463P</b>	Prof. 15 cm	5,5 L x 1	<b>26,75 €</b>
<b>49487P</b>	A - Couvercle avec poignée	x 1	<b>11,50 €</b>



**GN 1/1 perforé (53 x 32,5 cm)**

	Cont.		P.U.HT
<b>49421</b>	Prof. 4 cm	x 1	<b>28,75 €</b>
<b>49420</b>	Prof. 5,5 cm	x 1	<b>30,00 €</b>
<b>49419P</b>	Prof. 6,5 cm	x 1	<b>32,50 €</b>
<b>49418P</b>	Prof. 10 cm	x 1	<b>39,25 €</b>
<b>49417P</b>	Prof. 15 cm	x 1	<b>51,50 €</b>



**GN 1/4 (26,5 x 16,2 cm)**

	Cont.		P.U.HT
<b>49473</b>	Prof. 2 cm	- x 1	<b>15,00 €</b>
<b>49470P</b>	Prof. 10 cm	2,6 L x 1	<b>19,00 €</b>
<b>49469P</b>	Prof. 15 cm	3,8 L x 1	<b>29,00 €</b>
<b>49468</b>	Prof. 20 cm	4,8 L x 1	<b>45,00 €</b>
<b>49488</b>	A - Couvercle avec poignée	x 1	<b>11,40 €</b>



**GN 1/2 (32,5 x 26,5 cm)**

	Cont.		P.U.HT
<b>49461</b>	Prof. 2 cm	- x 1	<b>13,80 €</b>
<b>49460</b>	Prof. 4 cm	2,4 L x 1	<b>14,80 €</b>
<b>49459P</b>	E Prof. 6,5 cm	3,8 L x 1	<b>16,75 €</b>
<b>49458P</b>	E Prof. 10 cm	6 L x 1	<b>20,00 €</b>
<b>49457P</b>	E Prof. 15 cm	8,9 L x 1	<b>31,75 €</b>
<b>49486P</b>	A - Couvercle avec poignée	x 1	<b>13,20 €</b>
<b>49502</b>	B - Couvercle sans poignée	x 1	<b>13,80 €</b>



**GN 1/6 (17,6 x 16,2 cm)**

	Cont.		P.U.HT
<b>49477</b>	Prof. 6,5 cm	1,1 L x 1	<b>15,75 €</b>
<b>49476P</b>	Prof. 10 cm	1,6 L x 1	<b>16,00 €</b>
<b>49475P</b>	Prof. 15 cm	2,3 L x 1	<b>20,25 €</b>
<b>49489P</b>	A - Couvercle avec poignée	x 1	<b>11,20 €</b>



**GN 1/9 (17,6 x 10,8 cm)**

	Cont.		P.U.HT
<b>49479</b>	Prof. 6,5 cm	0,6 L x 1	<b>16,50 €</b>
<b>49491</b>	A - Couvercle avec poignée	x 1	<b>10,10 €</b>



**GN 1/2 perforé (32,5 x 26,5 cm)**

	Cont.		P.U.HT
<b>49431</b>	Prof. 4 cm	x 1	<b>26,50 €</b>
<b>49430</b>	Prof. 6,5 cm	x 1	<b>29,25 €</b>
<b>49430</b>	Prof. 10 cm	x 1	<b>40,50 €</b>
<b>49428</b>	Prof. 15 cm	x 1	<b>57,50 €</b>



**Plaque à rôtir**

Inox avec revêtement anti-adhésif.  
Tolérance - 28° à +230°C

	Cont.		P.U.HT
<b>49507P</b>	GN 1/1 - Prof. 6,5 cm	x 1	<b>70,00 €</b>
<b>49506P</b>	GN 1/2 - Prof. 6,5 cm	x 1	<b>48,50 €</b>



**GN 2/3 (35,4 x 32,5 cm)**

	Cont.		P.U.HT
<b>49453P</b>	Prof. 6,5 cm	5,4 L x 1	<b>32,75 €</b>
<b>49452</b>	Prof. 10 cm	8 L x 1	<b>35,00 €</b>
<b>49451</b>	Prof. 15 cm	11,9 L x 1	<b>38,00 €</b>
<b>49450</b>	Prof. 20 cm	15,5 L x 1	<b>74,50 €</b>
<b>49493</b>	A - Couvercle avec poignée	x 1	<b>25,25 €</b>

**Barrette de séparation**

	Cont.		P.U.HT
<b>43040P</b>	L. 32,5 cm	x 1	<b>3,70 €</b>
<b>43039P</b>	L. 53 cm	x 1	<b>4,90 €</b>

## Bac GN inox

### GN 2/1 (53 x 65 cm)

	Prof.	Cont.	P.U.HT
1010676	2 cm	6,5 L x 1	34,50 €
1010677	10 cm	31,5 L x 1	50,50 €
1010678	15 cm	44,9 L x 1	63,50 €
1010679P	20 cm	60 L x 1	85,00 €

GN 2/1

GN 1/1

### GN 1/1 (53 x 32,5 cm)

	Prof.	Cont.	P.U.HT
63430P	5,5 cm	7,2 L x 1	12,30 €
63431P	6,5 cm	8,5 L x 1	13,00 €
63432P	10 cm	13,3 L x 1	15,50 €
63433P	15 cm	20,6 L x 1	24,00 €
64299P	20 cm	30 L x 1	34,50 €
63435P	A - Couverture avec poignée	x 1	10,90 €
70358	E B - Couverture étanche avec poignée	x 1	56,00 €
70359P	E C - Couverture sans poignée	x 1	18,25 €

### GN 1/1 perforé (53 x 32,5 cm)

	Prof.	Cont.	P.U.HT
63430P	6,5 cm	8,5 L x 1	14,60 €
63434P	10 cm	13,3 L x 1	20,50 €

### GN 1/2 (32,5 x 26,5 cm)

	Prof.	Cont.	P.U.HT
70354P	5,5 cm	3,2 L x 1	9,80 €
64301P	6,5 cm	4,2 L x 1	8,70 €
64302P	10 cm	8 L x 1	11,60 €
64303P	15 cm	9,9 L x 1	17,50 €
64304P	20 cm	11,6 L x 1	22,75 €
64305P	A - Couverture avec poignée	x 1	6,10 €
70357	E B - Couverture étanche avec poignée	x 1	39,75 €

GN 1/2

### GN 1/3 (32,5 x 17,6 cm)

	Prof.	Cont.	P.U.HT
64306P	6,5 cm	2,5 L x 1	6,10 €
64307P	10 cm	3,8 L x 1	10,30 €
64308P	15 cm	5,9 L x 1	11,60 €
70355P	20 cm	8,1 L x 1	18,00 €
64309P	A - Couverture avec poignée	x 1	4,50 €

GN 1/3

### GN 1/4 (26,5 x 16,2 cm)

	Prof.	Cont.	P.U.HT
64310P	6,5 cm	1,9 L x 1	6,00 €
70356P	10 cm	2,5 L x 1	8,80 €
64311P	15 cm	4,1 L x 1	11,20 €
64312P	A - Couverture avec poignée	x 1	4,30 €

GN 1/4

### GN 1/6 (17,6 x 16,2 cm)

	Prof.	Cont.	P.U.HT
64313P	6,5 cm	1,1 L x 1	4,80 €
64314P	10 cm	1,6 L x 1	7,10 €
64315P	15 cm	2,2 L x 1	9,60 €
64316P	A - Couverture avec poignée	x 1	3,10 €

GN 1/6

### GN 1/9 (17,6 x 10,8 cm)

	Prof.	Cont.	P.U.HT
64317P	6,5 cm	0,7 L x 1	4,00 €
64318P	10 cm	1 L x 1	5,60 €
64319P	A - Couverture avec poignée	x 1	2,90 €

GN 1/9

Sécurisez les manipulations chaudes ! Utiliser une pince à plat chaud limitera les risques de brûlures ou de chute de bacs



## Pince pour plat chaud

Avec embout silicone.

	L.	Cont.	P.U.HT
63211P	19 cm	x 1	15,50 €



Sans Bisphénol A



GN 2/1

Léger, solide, incassable, indéformable, résiste aux chocs thermiques de -90°C à + 90°C, du congélateur au micro-ondes.

Coins tronqués pour faciliter l'introduction dans les échelles à glissières.



GN 1/1

A



GN 1/2



GN 1/3



GN 1/4



GN 1/6

## Bac Bank

Copolyester fumé.

### Durée de vie exceptionnelle :

- Incassable, indéformable et très résistant aux chocs thermiques de -90°C à +90°C,

### Sécurité et hygiène garantie

- Solidaire du Bank, le couvercle clipsable assure une sécurité parfaite pendant le transport et protège le contenu de toutes projections extérieures.
- Avec sa surface parfaitement lisse, le Bank se lave très facilement à la main ou en machine.
- Non micro-poreux, le Bank peut contenir successivement des aliments très différents et ne garde ni les odeurs, ni les bactéries.

### Organisation facile en cuisine

- Superposable et emboîtable, le Bank est idéal pour gagner de la place et organiser l'espace.
- Les coins tronqués et les bords retournés facilitent la prise en main.
- Les plages de litrage permettent de contrôler le niveau des préparations en un coup d'oeil.

### GN 2/1 (65 x 53 cm)

<b>54250P</b>	E Prof. 15 cm
<b>54251P</b>	E Prof. 20 cm
<b>54252P</b>	E Couvercle

Cont.		P.U.HT
36,4 L	x 1	<b>99,00 €</b>
48,3 L	x 1	<b>112,00 €</b>
-	x 1	<b>60,00 €</b>

### GN 1/1 (53 x 32,5 cm)

<b>54253P</b>	E Prof. 6,5 cm
<b>54254P</b>	E Prof. 10 cm
<b>54255P</b>	E Prof. 15 cm
<b>54256P</b>	E Prof. 20 cm
<b>54257P</b>	E A - Couvercle
<b>54258P</b>	E Égouttoir

Cont.		P.U.HT
7,1 L	x 1	<b>31,75 €</b>
12,1 L	x 1	<b>34,00 €</b>
18,2 L	x 1	<b>43,25 €</b>
24 L	x 1	<b>54,00 €</b>
-	x 1	<b>24,75 €</b>
-	x 1	<b>23,50 €</b>

### GN 1/2 (32,5 x 26,5 cm)

<b>54259P</b>	E Prof. 10 cm
<b>54260P</b>	E Prof. 15 cm
<b>54261P</b>	E Prof. 20 cm
<b>54262P</b>	E A - Couvercle
<b>54263P</b>	E Égouttoir

Cont.		P.U.HT
5,6 L	x 1	<b>20,00 €</b>
8,2 L	x 1	<b>23,25 €</b>
10,5 L	x 1	<b>31,25 €</b>
-	x 1	<b>15,25 €</b>
-	x 1	<b>11,50 €</b>

### GN 1/3 (32,5 x 17,6 cm)

<b>54265P</b>	E Prof. 10 cm
<b>54266P</b>	E Prof. 15 cm
<b>54267P</b>	E A - Couvercle
<b>54268P</b>	E Égouttoir

Cont.		P.U.HT
3,4 L	x 1	<b>15,50 €</b>
5 L	x 1	<b>18,00 €</b>
-	x 1	<b>10,70 €</b>
-	x 1	<b>9,10 €</b>

### GN 1/4 (26,5 x 16,2 cm)

<b>54270P</b>	E Prof. 15 cm
<b>54271P</b>	E A - Couvercle

Cont.		P.U.HT
3,6 L	x 1	<b>12,00 €</b>
-	x 1	<b>7,90 €</b>

### GN 1/6 (17,6 x 16,2 cm)

<b>54272P</b>	E Prof. 10 cm
<b>54273P</b>	E Prof. 15 cm
<b>54274P</b>	E A - Couvercle

Cont.		P.U.HT
1,5 L	x 1	<b>9,10 €</b>
2,2 L	x 1	<b>9,20 €</b>
-	x 1	<b>6,50 €</b>

## Bac copolyester Camview

Transparent pour une identification immédiate du contenu. Gradué. Empilable.  
Température d'utilisation de -40°C à +76°C.

Sans  
Bisphénol A



Choisir son bac :

GN 2/1 : 65 x 53 cm / GN 1/1 : 53 x 32,5 cm /  
GN 2/4 : 53 x 16,2 cm / GN 2/3 : 35,3 x 32,5 cm /  
GN 1/2 : 32,5 x 26,5 cm / GN 1/3 : 32,5 x 17,6 cm /  
GN 1/4 : 26,5 x 16,2 cm / GN 1/6 : 17,6 x 16,2 cm /  
GN 1/9 : 17,6 x 10,8 cm



A



B



GN 1/1



GN 1/2



GN 1/3



GN 1/4



GN 1/6



GN 1/9



C

### GN 1/1 (53 x 32,5 cm)

		Cont.		P.U. HT
<b>1006017P</b>	E Prof. 6,5 cm	8,5 L	x 1	<b>12,40 €</b>
<b>1006018P</b>	E Prof. 10 cm	13 L	x 1	<b>16,75 €</b>
<b>1006019P</b>	E Prof. 15 cm	19,5 L	x 1	<b>19,00 €</b>
<b>1006020P</b>	E Prof. 20 cm	25,6 L	x 1	<b>25,75 €</b>
<b>1006035P</b>	E A - Egouttoir	-	x 1	<b>10,00 €</b>
<b>1006037P</b>	E B - Couverture à poignée	-	x 1	<b>11,70 €</b>

### GN 1/2 (32,5 x 26,5 cm)

		Cont.		P.U. HT
<b>1006021P</b>	E Prof. 6,5 cm	3,9 L	x 1	<b>7,70 €</b>
<b>1006022P</b>	E Prof. 10 cm	5,9 L	x 1	<b>9,50 €</b>
<b>1006023P</b>	E Prof. 15 cm	8,9 L	x 1	<b>12,10 €</b>
<b>1006024P</b>	E Prof. 20 cm	11,7 L	x 1	<b>15,75 €</b>
<b>1006036P</b>	E A - Egouttoir	-	x 1	<b>4,70 €</b>
<b>1006038P</b>	E B - Couverture à poignée	-	x 1	<b>6,10 €</b>

### GN 1/3 (32,5 x 17,6 cm)

		Cont.		P.U. HT
<b>1006025P</b>	E Prof. 6,5 cm	2,4 L	x 1	<b>5,90 €</b>
<b>1006026P</b>	E Prof. 10 cm	3,6 L	x 1	<b>8,00 €</b>
<b>1006027P</b>	E Prof. 15 cm	5,3 L	x 1	<b>9,20 €</b>
<b>1006028P</b>	E Prof. 20 cm	6,9 L	x 1	<b>12,00 €</b>
<b>1006039P</b>	E B - Couverture à poignée	-	x 1	<b>4,50 €</b>

### GN 1/4 (26,5 x 16,2 cm)

		Cont.		P.U. HT
<b>1006029P</b>	E Prof. 10 cm	2,5 L	x 1	<b>6,90 €</b>
<b>1006030P</b>	E Prof. 15 cm	3,7 L	x 1	<b>8,00 €</b>
<b>1006040P</b>	E B - Couverture à poignée	-	x 1	<b>4,10 €</b>

### GN 1/6 (17,6 x 16,2 cm)

		Cont.		P.U. HT
<b>1006031P</b>	E Prof. 10 cm	1,5 L	x 1	<b>4,80 €</b>
<b>1006032P</b>	E Prof. 15 cm	2,2 L	x 1	<b>6,00 €</b>
<b>1006041P</b>	E B - Couverture à poignée	-	x 1	<b>3,60 €</b>

### GN 1/9 (17,6 x 10,8 cm)

		Cont.		P.U. HT
<b>1006033P</b>	E Prof. 6,5 cm	0,57 L	x 1	<b>4,40 €</b>
<b>1006034P</b>	E Prof. 10 cm	0,85 L	x 1	<b>5,00 €</b>
<b>1006042P</b>	E C - Couverture plat	-	x 1	<b>3,70 €</b>



## Bac polypropylène

Bacs GN translucide, permettant de mieux visualiser les aliments stockés.  
Très grande résistance.  
Peuvent supporter des températures allant de - 40 °C à + 70 °C.  
Faciles à nettoyer grâce à l'intérieur anti-adhésif lisse.  
Conformes à la norme européenne gastronorme EN 631-1.

Visualisation plus facile des aliments stockés.  
La largeur uniforme du rebord garantit une très bonne assise sur les tables et comptoirs.  
Attention : il est déconseillé d'utiliser les bacs sur les tables à bain-marie.  
Couvercles hermétiques.



### GN 1/1 (53 x 32,5 cm)

		Cont.		P.U.HT
	<b>1011179P</b>	E Prof. 6,5 cm	8,5 L x 1	<b>7,40 €</b>
✓	<b>54373P</b>	E Prof. 10 cm	13 L x 1	<b>9,40 €</b>
✓	<b>54372P</b>	E Prof. 15 cm	19,5 L x 1	<b>12,00 €</b>
✓	<b>59309P</b>	E Prof. 20 cm	25,6 L x 1	<b>16,25 €</b>
✓	<b>55102</b>	E Egouttoir	- x 6	<b>6,40 €</b>
✓	<b>47787P</b>	E Couvercle hermétique	- x 1	<b>7,30 €</b>

### GN 1/2 (32,5 x 26,5 cm)

			Cont.		P.U.HT
	<b>1011180P</b>	E Prof. 6,5 cm	3 L x 1		<b>4,60 €</b>
✓	<b>54375P</b>	E Prof. 10 cm	5,9 L x 1		<b>5,60 €</b>
✓	<b>54374P</b>	E Prof. 15 cm	8,9 L x 1		<b>7,10 €</b>
✓	<b>59308P</b>	E Prof. 20 cm	11,7 L x 1		<b>10,80 €</b>
✓	<b>55103</b>	E Egouttoir	- x 6		<b>2,90 €</b>
✓	<b>1008176P</b>	E Couvercle hermétique	- x 1		<b>4,90 €</b>

### GN 1/3 (32,5 x 17,6 cm)

			Cont.		P.U.HT
	<b>1011181P</b>	E Prof. 6,5 cm	2,4 L x 1		<b>3,40 €</b>
✓	<b>54377P</b>	E Prof. 10 cm	3,6 L x 1		<b>4,60 €</b>
✓	<b>54376P</b>	E Prof. 15 cm	5,3 L x 1		<b>5,40 €</b>
✓	<b>55104</b>	E Egouttoir	- x 6		<b>2,80 €</b>
✓	<b>1008175P</b>	E Couvercle hermétique	- x 1		<b>3,70 €</b>

### GN 1/4 (26,5 x 16,2 cm)

			Cont.		P.U.HT
	<b>1011182P</b>	E Prof. 6,5 cm	1,7 L x 1		<b>3,40 €</b>
✓	<b>54378P</b>	E Prof. 15 cm	3,7 L x 1		<b>5,20 €</b>
✓	<b>1008174P</b>	E Couvercle hermétique	- x 6		<b>3,30 €</b>

### GN 1/6 (17,6 x 16,2 cm)

			Cont.		P.U.HT
	<b>1011183P</b>	E Prof. 6,5 cm	1 L x 1		<b>2,70 €</b>
✓	<b>54380P</b>	E Prof. 10 cm	1,5 L x 1		<b>3,00 €</b>
✓	<b>54379P</b>	E Prof. 15 cm	2,2 L x 1		<b>3,90 €</b>
✓	<b>55105</b>	E Egouttoir	- x 6		<b>1,60 €</b>
✓	<b>1008173P</b>	E Couvercle hermétique	- x 6		<b>2,60 €</b>

Pour la traçabilité voir page 398



## Étiquette autocollante et biodégradable

**CAMBRO** **ACC**



Permet de consigner la nature du contenu et la date de péremption des aliments ! L'étiquette et la colle se dissolvent en moins de 30 secondes à l'eau courante ou au lave vaisselle sans laisser de résidus susceptibles de favoriser la prolifération des bactéries. Elles peuvent supporter des températures de congélation atteignant -40°C et de chaleur intense : 93°C pendant 4 heures.

Rouleau de 250 étiquettes avec boîte distributrice

			Cont.		P.U.HT
✓	<b>50703P</b>	E L. 7,6 x l. 5 cm	x 1		<b>41,25 €</b>





## Maestro Evercut

Gamme de couteaux dotée de la technologie Evercut, fusion par laser de carbures de titane et de l'acier sur le tranchant de la lame pour une qualité de coupe exceptionnelle. Acier haute qualité entièrement forgé, manche POM. Lame unie pleine soie. Mitre massive.



Couteau chef  
**1007640P** L. lame 21 cm

x1 **P.U. HT**  
**108,00 €**



Couteau à découper  
**1007641** L. lame 21 cm

x1 **P.U. HT**  
**104,00 €**

nouveau !



Couteau de cuisine  
**1013300P** L. lame 15 cm

x1 **P.U. HT**  
**94,50 €**



Couteau d'office  
**1007644P** L. lame 9 cm

x1 **P.U. HT**  
**64,00 €**

## Kasumi Damas

Lame en acier japonais VG10 à 1 % de carbone et damasquinage 32 couches, ce qui rend la lame moins cassante tout en lui assurant un rendu esthétique unique. Le manche est en lamelles de bois de cerisier, comprimées, teintées en noir puis trempées dans une résine spéciale garantissant la tenue du manche dans le temps. Couteau entièrement produit au Japon à Seki.



Couteau Yanagiba  
**1004772** L. lame 21 cm

x1 **P.U. HT**  
**193,00 €**



Couteau chef  
**1004775** L. lame 24 cm  
**1004774** L. lame 20 cm

x1 **P.U. HT**  
**162,00 €**  
x1 **154,00 €**



Couteau à découper  
**1004773** L. lame 24 cm

x1 **P.U. HT**  
**156,00 €**



Couteau Santoku  
**1004771** L. lame 18 cm

x1 **P.U. HT**  
**150,00 €**



Couteau d'office  
**1004770** L. lame 12 cm

x1 **P.U. HT**  
**93,00 €**



Couteau d'office  
**1004769** L. lame 8 cm

x1 **P.U. HT**  
**84,00 €**

Vendu sans couteaux



### Bloc aimanté Kasumi

Pour 6 couteaux. Aimants extrêmement puissants en néodymium. Dimension maximale des lames : 2 lames de 24 cm et 5,8 cm de large, 2 lames de 22 cm et 5 cm de large, 2 lames de 18 cm et 2,5 cm de large.

**1004768** L. 27 x l. 11,8 x H. 26,3 cm

x1 **P.U. HT**  
**200,00 €**



## Damas 67

L'acier VG10, hautement chargé en carbone, permet une plus grande dureté au tranchant et ainsi une grande longévité à la coupe.

L'alternance de feuilles d'acier 420 et 431, chargées en chrome et en nickel, garantit l'inoxydabilité du couteau.

Pourquoi 67 ? Car de part et d'autre de cette bande d'acier se trouvent 33 couches damassées, soit au total 67 couches.

Tout en élégance, les couteaux DAMAS 67 sont dotés d'un manche en matériau haut de gamme de type « Corian », à base de roche blanche et de résine acrylique.

Comparable au marbre pour sa dureté et ses belles couleurs, le manche présente une excellente résistance aux chocs, aux tâches, aux UV et aux bactéries.



Couteau chef			P.U.HT
<b>1011132P</b>	L. lame 25 cm	x 1	<b>134,00 €</b>
<b>1011130P</b>	L. lame 20 cm	x 1	<b>116,00 €</b>



Couteau à découper			P.U.HT
<b>1011134</b>	L. lame 23 cm	x 1	<b>129,00 €</b>



Couteau Santoku			P.U.HT
<b>1011129P</b>	L. lame 18 cm	x 1	<b>105,00 €</b>



Couteau d'office			P.U.HT
<b>1011128P</b>	L. lame 11 cm	x 1	<b>49,00 €</b>
<b>1011131P</b>	L. lame 9 cm	x 1	<b>48,00 €</b>

## Génération Y

Avec leur design inédit, ces couteaux allient prouesse technologique et esthétique, sublimant les lignes et fonctions originelles du couteau. L'acier qui compose cette nouvelle gamme est une valeur sûre, qui a déjà fait ses preuves. Très résistant à la corrosion, il possède une excellente tenue de coupe et se réaffûte facilement. Cet acier haute qualité est également coulé en France. La gamme Génération Y est dotée d'un manche exceptionnel : sans rivets ni clous. Ses deux faces sont assemblées grâce à un système exclusif pour demeurer absolument indémanchable.



Couteau chef			P.U.HT
<b>1008295P</b>	L. lame 25 cm	x 1	<b>55,50 €</b>
<b>1008296P</b>	L. lame 20 cm	x 1	<b>51,00 €</b>



Couteau à pain			P.U.HT
<b>1008301</b>	L. lame 19 cm	x 1	<b>46,25 €</b>



Couteau à découper			P.U.HT
<b>1008299</b>	L. lame 19 cm	x 1	<b>45,25 €</b>



Couteau de cuisine			P.U.HT
<b>1008298</b>	L. lame 15 cm	x 1	<b>42,25 €</b>



Couteau filet de sole			P.U.HT
<b>1008300</b>	L. lame 17 cm	x 1	<b>35,75 €</b>



Couteau d'office			P.U.HT
<b>1008297P</b>	L. lame 10 cm	x 1	<b>35,00 €</b>



Premium

## Grand Chef

Une lame en acier inoxydable de très haute qualité (0,5 % de carbone et 14 % de chrome), un meulage et un polissage très soignés.

Une mitre inox forgée de forme arrondie : grand confort d'utilisation.

Un manche en bois inaltérable qui combine plaisir du toucher et résistance au lavage.

Une résistance exceptionnelle de la lame pleine soie (visible autour du manche) et 3 rivets d'assemblage en laiton massif.



### Couteau chef

<b>35561</b>	L. lame 35 cm	x 1	<b>P.U.HT</b> <b>168,00 €</b>
<b>529P</b>	L. lame 30 cm	x 1	<b>129,00 €</b>

### Couteau tranchelard

<b>533</b>	L. lame 30 cm	x 1	<b>P.U.HT</b> <b>98,00 €</b>
------------	---------------	-----	---------------------------------

### Couteau éminceur

<b>530P</b>	L. lame 25 cm	x 1	<b>P.U.HT</b> <b>84,00 €</b>
<b>35562P</b>	L. lame 20 cm	x 1	<b>70,00 €</b>

### Couteau à découper

<b>43031P</b>	L. lame 22 cm	x 1	<b>P.U.HT</b> <b>60,50 €</b>
---------------	---------------	-----	---------------------------------

### Couteau de cuisine

<b>35563P</b>	L. lame 15 cm	x 1	<b>P.U.HT</b> <b>49,50 €</b>
---------------	---------------	-----	---------------------------------

### Couteau filet de sole

<b>534P</b>	L. lame 17 cm	x 1	<b>P.U.HT</b> <b>46,25 €</b>
-------------	---------------	-----	---------------------------------

### Couteau d'office

<b>35564P</b>	L. lame 10 cm	x 1	<b>P.U.HT</b> <b>39,25 €</b>
---------------	---------------	-----	---------------------------------

## Degscharf

Lame inox demi-soie, manche en bois pressé noir. Tradition et robustesse.



### Couteau de boucher

<b>1011142</b>	L. lame 30 cm	x 1	<b>P.U.HT</b> <b>68,00 €</b>
<b>1011140</b>	L. lame 25 cm	x 1	<b>55,00 €</b>
<b>1011137</b>	L. lame 20 cm	x 1	<b>43,75 €</b>

### Couteau à dénervier

<b>1011143</b>	L. lame 20 cm	x 1	<b>P.U.HT</b> <b>43,25 €</b>
----------------	---------------	-----	---------------------------------

### Couteau à désosser

<b>1011144</b>	E L. lame 14 cm Large	x 1	<b>P.U.HT</b> <b>35,00 €</b>
<b>1011145</b>	E L. lame 14 cm Usé	x 1	<b>34,50 €</b>

GRAND CHEF / DEGSCHARF



CUISINE

## Riviera

Collection 100% forgée. La gamme Riviera bénéficie, comme tous les couteaux Arcos, d'une formule d'acier exclusive enrichie à l'azote. Cet acier haut de gamme, qui associe finesse et dureté, dote les couteaux de performances de coupes supérieures aux aciers classiques. Son manche ergonomique lui confère une prise en main agréable et efficace.

Rivets en inox et traitement antibactérien « Bactiproof Silver » pour un maximum de solidité et d'hygiène.



Couteau chef		📦	P.U.HT
<b>69172</b>	L. lame 30 cm	x 1	<b>87,50 €</b>
<b>69171</b>	L. lame 25 cm	x 1	<b>57,00 €</b>
<b>69170</b>	L. lame 20 cm	x 1	<b>41,00 €</b>
<b>69169</b>	L. lame 15 cm	x 1	<b>32,75 €</b>



Couteau Santoku		📦	P.U.HT
<b>1011032</b>	L. lame 18 cm	x 1	<b>37,50 €</b>



Couteau filet de sole		📦	P.U.HT
<b>1011033</b>	L. lame 17 cm	x 1	<b>27,75 €</b>



Couteau d'office		📦	P.U.HT
<b>1011031</b>	L. lame 10 cm	x 1	<b>19,50 €</b>

## Haïku

Manche en bois traité peu absorbant. Lame cimentée, fixation virole en plastique et cheville en bambou comme les sabres japonais. Angle d'affûtage japonais de 10 à 15°. Lame en acier supérieur + molybdène/vanadium. Incompatible lave-vaisselle, pierre à aiguiser Haiku fortement recommandée. (cf page 423).



Couteau Sashimi		📦	P.U.HT
<b>60588</b>	L. lame 21 cm	x 1	<b>120,00 €</b>



Couteau Santoku		📦	P.U.HT
<b>60586</b>	L. lame 17 cm	x 1	<b>102,00 €</b>



Couteau chef		📦	P.U.HT
<b>60587</b>	L. lame 20 cm	x 1	<b>100,50 €</b>



Émineur Yanagiba		📦	P.U.HT
<b>60590</b>	L. lame 27 cm	x 1	<b>92,50 €</b>



Couteau à trancher		📦	P.U.HT
<b>60584</b>	L. lame 13 cm	x 1	<b>69,50 €</b>



Couteau d'office		📦	P.U.HT
<b>60583</b>	L. lame 12 cm	x 1	<b>62,50 €</b>
<b>60582</b>	L. lame 10 cm	x 1	<b>57,50 €</b>



# Fibrox

Lame en acier inoxydable de très grande qualité : les couteaux professionnels Victorinox ont acquis une réputation d'excellence dans le monde entier.  
 Manche en matière synthétique Fibrox : ergonomique et convaincant par sa sécurité optimale et ses propriétés antidérapantes.  
 Assemblage : la lame inox et le manche Fibrox sont assemblés par injection du Fibrox autour de la lame.  
 Tous les couteaux Fibrox peuvent être stérilisés à une température de 150°C.

	<b>Couteau de boucher</b>			<b>P.U.HT</b>	
	<b>65625</b>	E L. lame 36 cm x 1			<b>52,50 €</b>
	<b>65624</b>	E L. lame 31 cm x 1			<b>44,50 €</b>
	<b>65619</b>	L. lame 31 cm x 1		<b>P.U.HT</b>	
	<b>65618P</b>	L. lame 28 cm x 1			<b>40,25 €</b>
	<b>Couteau tranchelard</b>			<b>P.U.HT</b>	
	<b>65634P</b>	L. lame 30 cm x 1		<b>41,00 €</b>	
	<b>Couteau de cuisine</b>			<b>P.U.HT</b>	
	<b>65615P</b>	L. lame 25 cm x 1		<b>38,00 €</b>	
	<b>Couteau à découper</b>			<b>P.U.HT</b>	
	<b>65626P</b>	L. lame 22 cm x 1		<b>29,25 €</b>	
	<b>Couteau filet de sole</b>			<b>P.U.HT</b>	
	<b>65616P</b>	L. lame 18 cm x 1		<b>24,50 €</b>	
	<b>Couteau à saigner</b>			<b>P.U.HT</b>	
	<b>65632</b>	E L. lame 16 cm x 1		<b>17,75 €</b>	
	<b>Couteau à désosser</b>			<b>P.U.HT</b>	
	<b>65629P</b>	L. lame 16 cm x 1		<b>21,00 €</b>	
	<b>Couteau à désosser</b>			<b>P.U.HT</b>	
	<b>65633P</b>	L. lame 15 cm x 1		<b>20,00 €</b>	
	<b>Couteau d'office</b>			<b>P.U.HT</b>	
	<b>65635P</b>	L. lame 8 cm x 1		<b>3,50 €</b>	



# Colour Prof

Lame acier inoxydable Nitrum de très haute tenue avec traitement spécifique supplémentaire de trempe à froid ICE PLUS : dureté élevée et résistance à la corrosion. Manche ergonomique bimatière en polypropylène et gomme élastomère coulés séparément, assurant une étanchéité absolue. La gamme Colour Prof bénéficie en plus d'un traitement antibactérien du manche « Bactiproof Silver ». Utilisation de -40° à +135°C. Chaque couteau est fourni avec 6 clips de couleur différente à fixer sur le manche, en fonction des aliments à préparer.



### Couteau de boucher

Code	E L. lame	Quantité	P.U. HT
50350	35 cm	x 1	39,25 €
50349P	30 cm	x 1	27,75 €
50348P	25 cm	x 1	21,75 €
50347P	20 cm	x 1	18,00 €



### Couteau éminceur

Code	E L. lame	Quantité	P.U. HT
64385P	25 cm	x 1	20,50 €
64384P	20 cm	x 1	18,75 €



### Couteau filet de sole

Code	E L. lame	Quantité	P.U. HT
50358P	20 cm	x 1	17,25 €
55679	17 cm	x 12	15,50 €



### Couteau à dénervier

Code	E L. lame	Quantité	P.U. HT
55678	19 cm	x 1	16,50 €

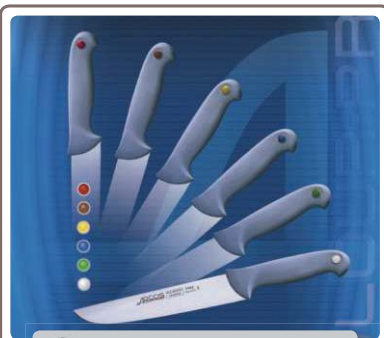

- Viandes crues
- Légumes crus
- Viandes cuites et charcuteries
- Poissons crus
- Fruits et salades
- Laitage, pains et viennoiseries



### Couteau à saigner

Code	E L. lame	Quantité	P.U. HT
55680	15 cm	x 12	15,50 €
64386P	13 cm	x 1	13,20 €



### Couteau à désosser

Code	E L. lame	Quantité	P.U. HT
50354P	15 cm	x 1	15,25 €



### Couteau d'office

Code	E L. lame	Quantité	P.U. HT
55681	8 cm	x 12	8,90 €



## Qualicoup



Lame pleine soie traversante en acier inoxydable au molybdène : tenue de coupe élevée.

Mitre inox pour une plus grande robustesse et un grand confort d'utilisation.

Manche en matière composite, 3 rivets, esthétique et ergonomique.



Couteau chef		☐	P.U.HT
✓ 50671P	E L. lame 30 cm	x 1	30,50 €
✓ 50672P	E L. lame 25 cm	x 1	26,75 €
✓ 50673P	E L. lame 20 cm	x 1	21,00 €
✓ 50674P	E L. lame 15 cm	x 1	19,50 €

Couteau à découper		☐	P.U.HT
✓ 50675P	E L. lame 25 cm	x 1	21,75 €

Couteau à pain		☐	P.U.HT
✓ 50679P	E L. lame 20 cm	x 1	19,25 €

Couteau d'office		☐	P.U.HT
✓ 50676P	E L. lame 11 cm	x 1	10,40 €
✓ 50677P	E L. lame 9 cm	x 1	10,00 €

## 1<sup>er</sup> PRIX



## Fushi

Lame en acier inoxydable au molybdène assurant une tenue de coupe élevée. Manche et mitre en inox pour une prise en main optimale. Hygiène assurée et entretien facile.

Couteau chef		☐	P.U.HT
50680P	E L. lame 30 cm	x 1	32,75 €
50681P	E L. lame 25 cm	x 1	26,75 €
50682P	E L. lame 20 cm	x 1	23,00 €
50683P	E L. lame 15 cm	x 1	20,75 €

Couteau à découper		☐	P.U.HT
50684P	E L. lame 25 cm	x 1	26,25 €

Couteau à pain		☐	P.U.HT
50688P	E L. lame 20 cm	x 1	23,25 €

Couteau d'office		☐	P.U.HT
50685P	E L. lame 11 cm	x 1	12,80 €
50686P	E L. lame 9 cm	x 1	10,50 €

## Butcher's line

Lame pleine soie en acier inoxydable au molybdène pour une tenue de coupe élevée. Manche ergonomique en POM (polyoxyméthylène), 3 rivets.

Couteau de boucher		☐	P.U.HT
54393P	E L. lame 35 cm	x 1	33,50 €
54394P	E L. lame 30 cm	x 1	31,75 €
54395P	E L. lame 25 cm	x 1	20,75 €
54396P	E L. lame 20 cm	x 1	18,00 €

Couteau à dénervé		☐	P.U.HT
54399P	E L. lame 20 cm	x 1	14,50 €

Couteau à saigner		☐	P.U.HT
54398P	E L. lame 16 cm	x 1	12,80 €

Couteau à désosser		☐	P.U.HT
54397P	E L. lame 16 cm	x 1	12,70 €

Couteau filet de sole		☐	P.U.HT
54400P	E L. lame 17 cm	x 1	11,20 €



## Couteau d'office avec mitre

Premium



Grand chef  
Manche bois.



🛒 **35564P** L. lame 10 cm x 1 **P.U.HT 39,25 €**

Couteau d'office  
Mitre massive. Manche ABS.



🛒 **1001025P** E L. lame 9 cm x 1 **P.U.HT 10,20 €**  
 🛒 **38793** E L. lame 7 cm x 12 **P.U.HT 9,70 €**

Qualicoup  
Manche composite.



🛒 **50676P** E L. lame 11 cm x 1 **P.U.HT 10,40 €**  
 🛒 **50677P** E L. lame 9 cm x 1 **P.U.HT 10,00 €**

## Couteau d'office

Colour Prof  
Manche bi-matière.



🛒 **55681** E L. lame 8 cm x 12 **P.U.HT 8,90 €**

FibroX



🛒 **65635P** L. lame 8 cm x 1 **P.U.HT 3,50 €**

## 1<sup>er</sup> PRIX

Manche plastique  
Lame émouée.



🛒 **58166P** E L. lame 10 cm x 1 **P.U.HT 2,30 €**

Manche plastique



🛒 **37791P** E L. lame 8 cm x 12 **P.U.HT 1,30 €**

Manche plastique  
Lame microdentée.



🛒 **58167P** L. lame 9 cm x 1 **P.U.HT 1,10 €**

### URBAN CASE

Plus de résistance : Le polypropylène dont est fait la mallette est un matériau très résistant, léger, conforme HACCP et lavable en machine. En nylon ultrarésistant, la sacoche présente une solidité à toute épreuve : fond doublé, renforts latéraux, doubles coutures sur les anses, bandoulière amovible. L'Urban case est spécialement conçue pour les étudiants en hôtellerie et les cuisiniers en déplacement.



## Urban Case



Mallette polypropylène et sacoche tissu synthétique. Sécurité : grâce au système de peignes en polypropylène (réglables en fonction de la longueur des lames) les couteaux sont parfaitement immobilisés dans la mallette.

### Mallette de cuisine 20 pièces et sacoche

Composition : - Eminceur chef 20 cm - Office 10 cm - Désosseur large 11 cm - Filet de sole 17 cm - Fusil 25 cm - Spatule inox 21 cm - Fourchette courbe - Ciseaux inox 22 cm - Aiguille à brider inox 20 cm - Eplucheur - Canneleur - Cuillère à pomme Ø 22 mm - Vide-pomme Ø 15 cm - Poche nylon 35 cm - Fouet inox 25 cm - Corne à ramasser - Douille unie U13 - Douille cannelée EB - Limonadier ABS - Spatule exoglass 30 cm.

🛒 **1004685** L. 49 x l. 12,5 x H. 40 cm x 1 **P.U.HT 150,00 €**



### Mallette vide et sacoche

🛒 **1004684** L. 49 x l. 12,5 x H. 40 cm x 1 **P.U.HT 34,75 €**



## Trousse pour 12 couteaux



En toile enduite. Comprenant un volet qui se rabat pour protéger les lames. Taille maximum de lame 30 cm. Le système de pliage isole les couteaux 3 par 3 évitant les chocs entre les lames. Poignée et sangle de transport.

🛒 **58444** L. 73 x l. 51 cm x 1 **P.U.HT 36,00 €**





DEGLON GARANTIE 1 an CE

## Affûteuse électrique

Affûtage en une seule étape, efficace et facile d'utilisation. 2 à 3 passages successifs suffisent pour obtenir un tranchant très acéré et sans bavure. Très simple d'utilisation, elle aigüise de façon précise et régulière grâce au croisement de 4 meules et le guide de positionnement de la lame. Convient parfaitement à toutes sortes de couteaux. 230 V.



**50473P** E L. 15,5 x l. 14,5 x H. 9,5 cm x 1 **P.U.HT 200,00 €**

## Aigüiseur rapide Red Steel à main

Boîtier en polypropylène, 4 tiges en inox diamanté. Permet de garder un angle constant de 30 degrés pour un affilage idéal. Durée de vie supérieure à un fusil traditionnel. Vendu sans socle.



**59537P** E L. 22 x l. 18 x H. 7 cm x 1 **P.U.HT 77,00 €**

## 1<sup>er</sup> PRIX

### Affûteur manuel

Affûtage simple et rapide en 2 étapes : 2 meules croisées en carbure pour redresser le tranchant avec un angle régulier et 2 petites meules céramique pour affiner le tranchant préalablement affûté. Poignée ergonomique. Pieds de stabilisation en caoutchouc.



**1001021P** L. 19,7 x l. 6,1 x H. 6,4 cm x 1 **P.U.HT 17,75 €**

### Barre inox aimantée



**50666P** E L. 36 cm x 1 **P.U.HT 26,50 €**  
**58138P** E L. 45 cm x 1 **P.U.HT 34,00 €**

## 1<sup>er</sup> PRIX

### Barre plastique aimantée



**58139P** E L. 36 cm x 1 **P.U.HT 16,75 €**  
**58140P** E L. 45 cm x 1 **P.U.HT 22,75 €**

## FUSILS/PIERRES À AIGÜISER

Premium

### Fusil Titanium

Mèche recouverte de nitrure de titane. Taillage extra fin, spécialement étudié pour aigüiser les couteaux les plus durs.



Mèche L. 30 cm **P.U.HT**  
**38791P** Mèche ronde x 1 **110,00 €**  
**38792** Mèche ovale x 1 **107,00 €**

### Fusil boucher

Dureté exceptionnelle de 2500 vickers. Longévité et qualité de coupe des couteaux garanties. Chromé dur. Manche ABS.



Mèche L. 30 cm **P.U.HT**  
**52480** Mèche ronde x 6 **28,25 €**  
**52479** Mèche ovale x 6 **36,25 €**

## 1<sup>er</sup> PRIX

### Fusil

Couche protectrice de chrome. Mèche taillage normal. Manche plastique.



Mèche L. 30 cm **P.U.HT**  
**59108P** E Mèche ronde x 1 **12,50 €**  
**59109P** E Mèche ovale x 1 **22,50 €**

### Pierre à aigüiser Haiku

Granulage 800.

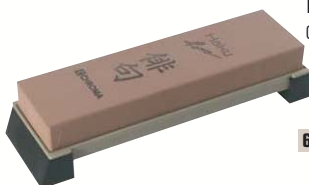

**60591** L. 18 x l. 5,2 x H. 1,9 cm x 1 **P.U.HT 66,50 €**

### Pierre à aigüiser

Au corindon. Moulé à très haute température. Pierre ovale.



**1005024** L. 24 x l. 3 x H. 1,5 cm x 1 **P.U.HT 10,40 €**

### Pierre à aigüiser naturelle

Tranchant poli à grain moyen.



**1004** L. 24 x l. 4 x H. 1,2 cm x 6 **P.U.HT 6,40 €**



### Coupe-pain socle polyéthylène

Coupe parfaite sur le pain frais, sans écrasement grâce à la lame 1/2 lune. Butée réglable. Epaisseur des tranches de 5 à 85 mm. Carter de sécurité pour la protection des doigts. Socle en polyéthylène avec 4 ventouses. L. 24 x l. 22 x H. 41,3 cm.



45497 L. lame 25 cm

**P.U.HT**  
x 1 **231,00 €**



### Coupe-pain socle inox

Socle inox, lame acier inoxydable trempé. Coupe efficace même sur pain frais grâce au nouveau système de fixation de la lame. 4 patins anti-dérapants. Poids : 2,8 kg. L. 52 x l. 13,5 x H. 11 cm.



51419P E L. lame 35 cm

**P.U.HT**  
x 1 **179,00 €**



### Couteau à pain

Lame inox dentelée. L. lame 20 cm.

- ✓ 50679P E A - Manche composite 3 rivets
- ✓ 48255P E B - Manche plastique

**P.U.HT**  
x 1 **19,25 €**  
**P.U.HT**  
x 1 **4,40 €**



### Couteau à génoise

Manche ABS. Petites dents.

✓ 56028P E L. lame 28 cm

**P.U.HT**  
x 1 **20,25 €**



### Couteau à fromage

Manche ABS.

- 2 mains
- ✓ 549 A - L. lame 42 cm
- ✓ 35575 A - L. lame 33 cm

**P.U.HT**  
x 2 **78,50 €**  
x 1 **62,00 €**



- 1 main
- 547 B - L. lame 25 cm

**P.U.HT**  
x 6 **38,50 €**



### Couteau à jambon

Manche polyoxyméthylène (POM). Lame inox alvéolée. 3 rivets.

✓ 50669P E L. lame 30 cm

**P.U.HT**  
x 1 **18,25 €**



### Couteau pour surgelés

35573 L. lame 23 cm

**P.U.HT**  
x 6 **31,50 €**



nouveau !

Avec guide réglable



### Couteau à saumon / jambon

Manche palissandre wengé 3 rivets laiton.

1013380 L. lame 40 cm

**P.U.HT**  
x 1 **144,00 €**



## SPÉCIAL POISSON



### Couteau à poisson à dents

Manche surmoulé bleu. Lame crantée.

56349P L. lame 33 cm

**P.U.HT**  
x 1 **56,50 €**



### Ecailleur à poisson

Lame crantée inox. Haute résistance à la lame avec écrous de renfort. Manche ergonomique et surmoulé plastique.

1005013P L. lame 16 cm

**P.U.HT**  
x 1 **47,00 €**



### Ciseaux à poisson

✓ 1005012P L. lame 23 cm

**P.U.HT**  
x 1 **20,00 €**



Couteau à huîtres, voir page 104



### Pince à arêtes

Lame inox avec branches "mi souples - mi rigides".

✓ 1001024P L. 11 cm

**P.U.HT**  
x 1 **8,80 €**





## Batte à côtelettes

Inox. Poids 1 kg.



**56348** L. 20,3 x l. 8,9 cm x 1 **P.U.HT 131,00 €**



## Hâchoir berceuse

3 lames en acier.  
Poignées polypropylène.

**56027** L. lame 33 cm x 1 **P.U.HT 104,00 €**



## Feuille de boucher

Avec renfort, lame inox, manche thermostatique. Ép. lame 2,25 mm.



**51765** L. 24 cm x 1 **P.U.HT 90,50 €**  
**51764** L. 26 cm x 1 **P.U.HT 76,50 €**



## Attendrisseur

Inox. Poids 2 kg.

**67602P** Ø 11 cm x 1 **P.U.HT 75,00 €**



## Scie de boucher

Monture et lame en inox.  
Manche plastique.



**52476** L. 45 cm x 1 **P.U.HT 63,00 €**  
**52477** Lame seule 50 cm x 1 **P.U.HT 8,50 €**



## Couteau à abattre

Lame inox épaisseur 5,5 mm.  
Manche ABS. 3 rivets.



**560** L. lame 30 cm x 1 **P.U.HT 66,50 €**



## Couperet

Manche ABS.



**1001023P** L. lame 18 cm x 1 **P.U.HT 40,75 €**

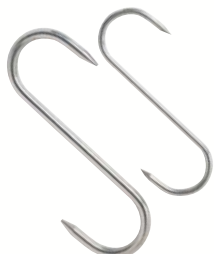

## Esse

Inox.

**568** L. 20 cm x 10 **P.U.HT 4,90 €**  
**567** L. 18 cm x 10 **P.U.HT 1,90 €**  
**35624** L. 16 cm x 10 **P.U.HT 1,60 €**  
**566** L. 14 cm x 10 **P.U.HT 1,50 €**  
**1001558P** L. 12 cm x 1 **P.U.HT 1,30 €**  
**35625** L. 8 cm x 10 **P.U.HT 0,86 €**



## Porte-roll's

À suspendre.

**Dévidoir avec ficelle** **48649P** Lin blanc 35/2. 1kg. x 1 **P.U.HT 33,25 €**

**Porte-roll's inox** **1000** 18 x 13,5 x H21 cm x 1 **P.U.HT 26,50 €**



## Roll's

Ficelle lin blanc 35/2. 1kg.

**Avec tube** **48651P** x 1 **P.U.HT 33,75 €**



**Sans tube pour dévidoir 48649P**

**68514P** x 1 **P.U.HT 21,25 €**



## Aiguille à brider



Inox.

**Courbe**  
**35395** L. 30 cm x 100 **P.U.HT 4,80 €**  
**35394** L. 25 cm x 100 **P.U.HT 3,90 €**  
**2181** L. 20 cm x 100 **P.U.HT 3,40 €**  
**35393** L. 15 cm x 100 **P.U.HT 3,10 €**

**Droite**  
**35392** L. 30 cm x 100 **P.U.HT 4,70 €**  
**35391** L. 25 cm x 100 **P.U.HT 3,70 €**  
**2180** L. 20 cm x 100 **P.U.HT 3,30 €**  
**35390** L. 15 cm x 100 **P.U.HT 2,90 €**



## Coupe volaille



Inox. Manche bi-matière antiglisse.

**48514P** E. L. lame 8 cm x 1 **P.U.HT 22,00 €**



## Ciseaux de cuisine



Bi-matière.

**56351** E. L. 22 cm x 1 **P.U.HT 6,70 €**



## Reconstituteur à steak



Inox. Permet de reconstituer une forme ovale pour les viandes hachées. (poids du steak environ 150 g).

**1005025** 36 x 10,5 cm x 1 **P.U.HT 38,50 €**





## Armoire de stérilisation



Inox brossé. Installation dans tous types de pièces, y compris ambiances humides. Porte en plexiglas transparent fumé. Fermeture magnétique. Poids 9 kg.

**Armoire 20 couteaux**  **P.U.HT**  
**49366P** E 60 x 51 x P. 12,5 cm x 1 **206,00 €**

**Ampoule de recharge**  
**1013431** E 15 W x 1 **28,75 €**



L'effet du rayonnement UV 254 nm n'est plus à démontrer : totalement bactéricide, virucide, germicide, etc. Les armoires génératrices d'ozone assurent ainsi une excellente décontamination des ustensiles placés sur le support. Après avoir nettoyé les couteaux, les placer sur le panier-support et actionner la minuterie réglable de 0 à 2 heures (durée conseillée : 1 h 30). À la fin de ce laps de temps, les couteaux sont stérilisés et prêts à être réutilisés.



**1er PRIX**



## Protection anti-coupure

Inox. CE ISO en 13998 niveau 2.

**Tablier**  **P.U.HT**  
**6646** 80 x 55 cm x 1 **126,00 €**



## Gant 100 % inox



Le gant en cote de mailles est recommandé pour la protection contre les coupures et coups provoqués par l'emploi d'un couteau à main ou électrique à lame circulaire ou verticale. Sans manchette. Conforme aux normes EN 14328 - EN 1811 et EN 1082-1 - ISO 13999.

**Taille Moyen**  **P.U.HT**  
**41542P** Le gant x 1 **104,00 €**



## Gant anti-coupures



Gant tricoté ambidextre. Indice 5 à la coupure, ce gant est recommandé pour couper mais aussi pour nettoyer les outils coupants et pour ouvrir les huîtres. Bleu.

**Taille 9**  **P.U.HT**  
**64707P** Le gant x 1 **24,00 €**

**1er PRIX**



## Gants anti-chaueur

Norme EN 420. L. 45 cm. Blanc-crème.

**Rouge**  **P.U.HT**  
**64697P** E La paire x 1 **10,80 €**

## Gant anti-chaueur Temp Cook



En nitrile. Protection thermique jusqu'à 250°C. Gant lavable intérieur / extérieur pour une meilleure hygiène. Résistance aux huiles, graisses et aux principaux produits détergents. Manchette longue pour une protection des avants-bras lors de la manipulation de plats chauds. Répond aux standards vestimentaires de la Restauration Hors Foyers (RHF). Norme EN 420. L. 45 cm. Blanc-crème.



**Taille 11**  **P.U.HT**  
**66428P** E La paire x 1 **65,50 €**

## Moufle anti-chaueur Orka Pro



Silicone non poreuse et non absorbante. Protège du grill, des plats, des braises ou flammes directes, des graisses et de l'huile. Entretien facile : sous l'eau, au lave-vaisselle. Antidérapant : les rainures assurant une excellente préhension. Ambidextre, taille unique avec trou de suspension. Étanche, résistant jusqu'à 300°C. Conforme norme EN702/EN407.



**La moufle**  **P.U.HT**  
**54040P** E Taille courte - protection du poignet L. 29 x l. 14 cm x 1 **21,75 €**

**54041P** E Taille longue - protection de la manche L. 44 x l. 18 cm x 1 **36,50 €**



## Gant anti-chaueur



Gant de protection thermique jusqu'à 350°C, antinflamme, antichaleur. Fabriqué en fibres de Nomex et de Kevlar. Intérieur doublé 83% coton et 17% polyester. Excellente prise en main grâce aux 5 doigts mobiles. Lavable en machine 60°C. Ambidextre. Jaune crème.

**Taille 9**  **P.U.HT**  
**1000079** E Le gant x 1 **15,25 €**



## Gant anti-froid



En nitrile. Préconisé pour une utilisation en chambre froide.

**La paire**  **P.U.HT**  
**1011591P** E Taille 9 x 1 **9,00 €**



Chaque couleur de planche a une application différente, pour éviter les contaminations croisées conformément aux recommandations H.A.C.C.P. Rouge : viande crue, Bleu : poisson, Blanc : fromage, Brun : viande cuite, Vert : légume.



### Planche à découper avec rigole

En polyéthylène haute densité. Blanc.



71116P	E L. 35 x l. 25 x H. 1 cm	x 1	P.U.HT 14,20 €
	Avec poignée		



### Lot de 6 planches sans rigole



Planches couleurs en polyéthylène livrées avec présentoir servant aussi de séchoir et de rangement.

50593P	E L. 45,5 x l. 30 x H. 1,3 cm	x 1	P.U.HT 114,00 €
--------	-------------------------------	-----	--------------------



### Planche à découper sans rigole

En polyéthylène haute densité. H. 2 cm. Blanc.



71119P	E L. 40 x l. 30 cm	x 1	P.U.HT 23,25 €
71118P	E L. 53 x l. 32,5 cm	x 1	31,75 €
71117P	E L. 60 x l. 40 cm	x 1	39,00 €



### Rack égouttoir 6 planches

Tout inox, jusqu'à 6 planches. Espace entre chaque séparateur : 3,2 cm.

67665P	E L. 25 x l. 31 x H. 27 cm	x 1	P.U.HT 39,25 €
--------	----------------------------	-----	-------------------



### Planche à découper avec rigole

En polyéthylène haute densité. H. 2 cm. Blanc.



71115P	E L. 53 x l. 32,5 cm GN 1/1	x 1	P.U.HT 34,75 €
71114P	E L. 60 x l. 40 cm	x 1	46,25 €



### Ra cloir

Polyéthylène. Facilite l'entretien en supprimant entailles et taches sur les planches et billots de découpe. Lame interchangeable et réversible en acier trempé.

45166P	L. 16,5 x l. 6,5 x H. 9,5 cm	x 1	P.U.HT 46,00 €
45167P	Lame de rechange	x 1	15,50 €



### Planche à découper sans rigole

En polyéthylène haute densité. L. 60 x l. 40 x H. 2 cm.



71122P	E Marbré	x 1	P.U.HT 36,75 €
71121P	E Brun	x 1	36,75 €
71124P	E Vert	x 1	36,75 €
71123P	E Rouge	x 1	36,75 €
71120P	E Bleu	x 1	36,75 €
1013458P	E Jaune	x 1	36,75 €



### Grattoir de plot

Lame inox. Manche plastique.



562	L. lame 17 cm	x 1	P.U.HT 9,40 €
-----	---------------	-----	------------------



### Brosse métallique

Extra dure. Manche bois 4 rangs.



49797P	L. 30 cm	x 1	P.U.HT 3,30 €
--------	----------	-----	------------------



**Toqueur à œufs**

Pour œufs crus, coques ou mollets.

INOX  
18/10

Facile : posez la cloche sur l'œuf. Tirez la petite boule noire et relâchez sans hésiter. Décollez le morceau de coquille découpé.

**45160P**

Toqueur à œuf

x 1

**P.U.HT**  
**27,00 €****Coupe-œufs en quartiers**

Fonte d'aluminium revêtu, fils inox.

**57147P**

E 6 quartiers

x 1

**P.U.HT**  
**14,50 €****Coupe-œufs en rondelles**

Fonte d'aluminium revêtu, fils inox.

**57146P**

E 10 rondelles

x 1

**P.U.HT**  
**12,60 €****Roquefortaise**

Socle marbre.

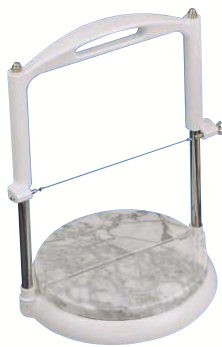
**56287**

Ø 27 cm

x 1

**P.U.HT**  
**142,00 €****56488**

Paquet de 10 fils

x 1

**8,50 €****56489**

Tendeur pour roquefortaise

x 1

**9,80 €****Lyre**

Inox.

**55794**

Lyre inox pour fils de 21 cm

x 1

**P.U.HT**  
**8,60 €****55795**

Paquet de 100 fils l. 21 cm

x 1

**47,75 €****55792P**

Lyre inox pour fils de 17 cm

x 1

**8,80 €****55793**

Paquet de 100 fils l. 17 cm

x 1

**47,75 €****RÂPES***Premium***Râpe Gourmet Microplane**

Inox. Dispose d'un manche ergonomique et d'embouts en caoutchouc antidérapants pour un travail efficace en toute stabilité. Large surface utile 13 x 5,7 cm.

**1005001P**

Grain fin

x 1

**P.U.HT**  
**24,50 €****1005002P**

Grain moyen

x 1

**P.U.HT**  
**24,50 €****Râpe zesteur****1005003P**

Grain fin

x 1

**P.U.HT**  
**18,00 €**

Inox. Large surface utile : 20,3 x 2,5 cm.

**Râpe de précision**

Poignée ergonomique Soft touch. Pied anti-glisse.

Grain fin et moyen

**1004237P**

Lame L. 22 x l. 3,5 cm

x 1

**P.U.HT**  
**12,20 €**

Grain extra fin

**1004236P**

Lame L. 13,5 x l. 6,5 cm

x 1

**P.U.HT**  
**12,20 €****Râpe 4 faces**

Inox. Dotée de 4 râpes différentes.

**1004235P**

L. 10,5 x l. 8,2 x H. 23 cm

x 1

**P.U.HT**  
**12,60 €**



## Décofruit V

Grand modèle.  
Inox. Manche polypropylène.

53096

x 12

P.U.HT  
7,10 €



## Couteau à pamplemousse

Inox. Manche polypropylène.  
Lame cambrée.

51772

L. 20,5 cm

x 12

P.U.HT  
8,00 €



## Canneleur décozesteur

Inox. Manche polypropylène.

782

Droitier

x 12

P.U.HT  
7,50 €



## Canneleur

Inox. Manche polypropylène. L. 15,2 cm.

Simple

50797P

Droitier

x 1

P.U.HT  
4,50 €

53095P

Gaucher

x 1

5,30 €



Double

45143

L. 10 cm

x 12

P.U.HT  
6,40 €



## Vide-pomme

Inox. Manche polypropylène.

69205P

Ø 1,5 cm

x 1

P.U.HT  
5,10 €

67600P

Ø 2 cm

x 1

10,10 €



## Emporte-cœur

Inox. Manche polypropylène.

45141

Ø 2 cm

x 12

P.U.HT  
10,20 €

45142

Ø 4 cm

x 12

10,60 €

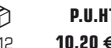

## Cuillère à pommes/melons

Inox. Manche polypropylène.

Simple

69386P

Ø 1,5 cm

x 1

P.U.HT  
3,60 €

69385P

Ø 2,2 cm

x 1

3,60 €

Double

69384P

Ø 2,2 et 2,8 cm

x 1

P.U.HT  
6,40 €



## Eplucheur

Manche polypropylène.

Avec virole

45131P

L. lame 7 cm

x 1

P.U.HT  
4,30 €



## 1<sup>er</sup> PRIX

## Eplucheur

Manche polypropylène.

Sans virole

37790P

E L. lame 6 cm

x 1

P.U.HT  
1,30 €



## Rase-tout

VICTORINOX

Manche polypropylène noir, lame à double denture intérieure. Convient pour tous les fruits et légumes mous (tomates, kiwis, pêches, poivrons...).

69174P

L. 18 x l. 2 cm

x 1

P.U.HT  
6,00 €



## Coquilleur à beurre

Manche polypropylène.

51773

x 12

P.U.HT  
6,80 €



## Equeuteur à tomates

Tout inox.

45155P

L. 19 cm

x 1

P.U.HT  
4,10 €



## Couteau à tomates

Manche polypropylène. Lame microdentée.

48366P

E L. lame 10 cm

x 1

P.U.HT  
2,60 €



## Eminceur à cornichons

Manche ABS. Pour radis, fraises, cornichons...

45154P

x 1

P.U.HT  
10,10 €



## PÈLE-POMMES



### Kali

Fonte d'aluminium. Pèle, étrogne et émince en une seule opération tous les fruits à trognons. Épaisseur des tranches 4 mm (fixe). Réglage de l'épaisseur de la peau et du diamètre du trognon. Réglage de la pression du peleur sur le fruit. Permet la découpe de zestes d'oranges ou de citrons. Lames en acier inoxydable trempé réaffutables. Fixation serre-joint.

50396P

E L. 34 x l. 10 x H. 11 cm

x 1

P.U.HT  
213,00 €

53577

Peleur complet

x 1

51,00 €

### Pèle-pommes

Fonte d'aluminium. Epluche, tranche et vide la pomme en une seule opération. Fixation par ventouse.

1005118P

E L. 30 x l. 10,5 x H. 13,2 cm

x 1

P.U.HT  
28,75 €

## 1<sup>er</sup> PRIX



Poussoir ergonomique anti-glisse.  
Prise en main sûre

Sécurité totale  
avec chariot et  
poussoir protecteur

## Mandoline Vantage

de Buyer  
MADE IN FRANCE  
MADE IN FRANCE

Plateau lisse réglable épaisseur de 1 à 10 mm.  
4 peignes Julienne 2- 4 - 7 et 10 mm.  
Protège-lame lisse en V pour le rangement de la mandoline.  
Boîte de rangement pour peignes Julienne.  
Chariot pour légumes/fruits et poussoir protecteur ergonomique.

Lame en V pour couper tous  
les fruits/légumes, même  
les plus mous

Encombrement minimum.  
Pied repliable

Châssis tout inox, robuste et  
résistant. Usage professionnel

1007375P E. L. 50 x l. 15 x H. 20 cm - 1,83 kg

x 1 P.U.HT  
134,00 €

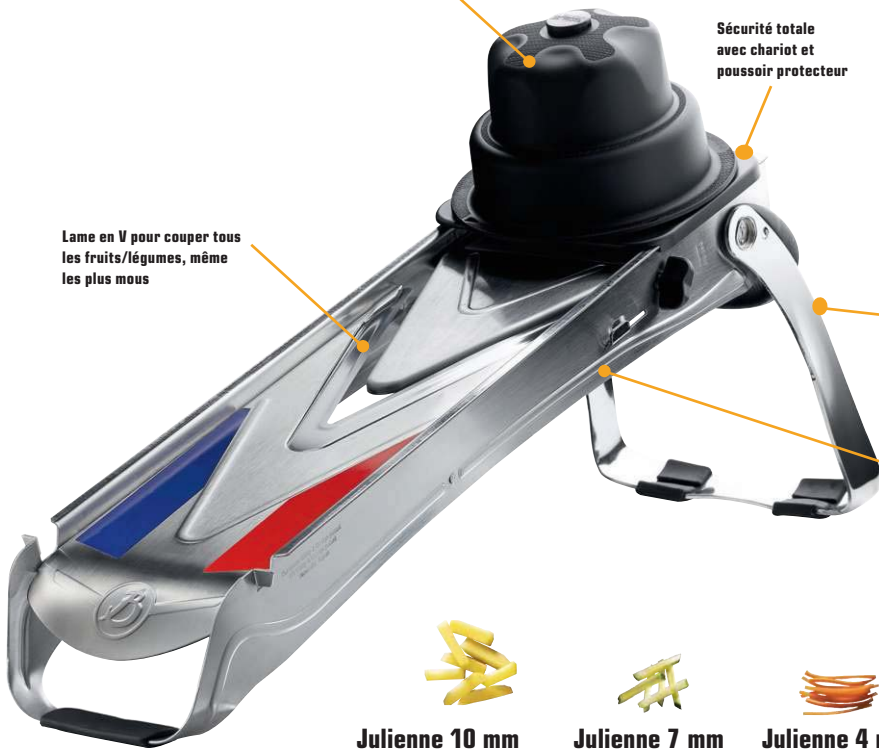

Julienne 10 mm

Julienne 7 mm

Julienne 4 mm

Julienne 2 mm

Tranche

Rondelle



nouveau !



Pour couper toutes  
rondelles en sécurité,  
efficacité, simplicité  
et rendement

## Poussoir manuel

de Buyer  
MADE IN FRANCE

Poussoir à rondelles adaptable sur toutes les mandolines  
De Buyer.

1013432P Ø 5 x H. 14,5 cm

x 1 P.U.HT  
13,70 €

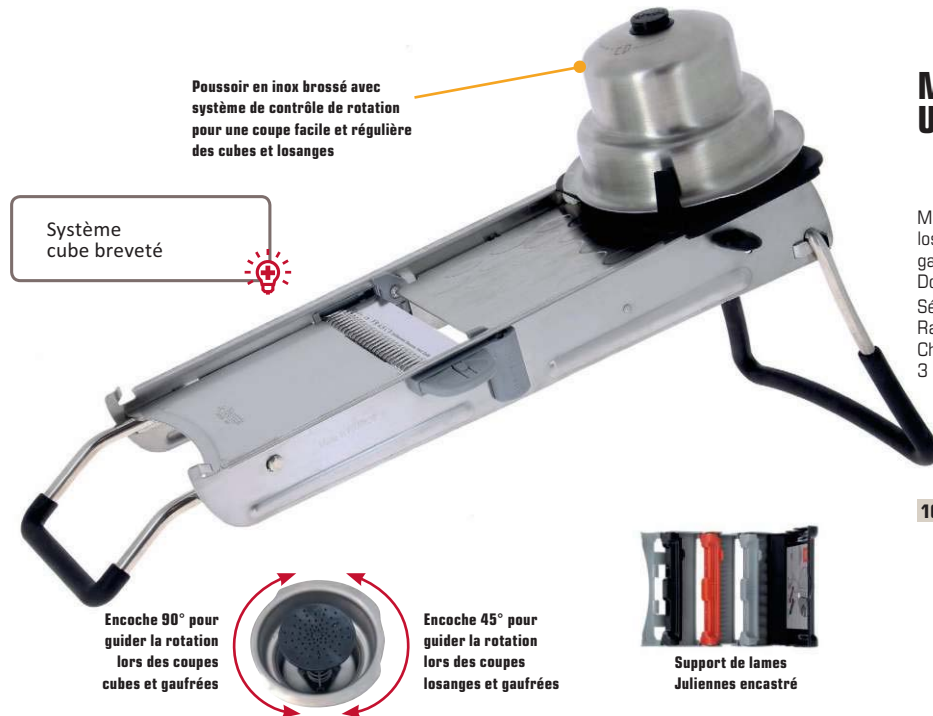

Poussoir en inox brossé avec  
système de contrôle de rotation  
pour une coupe facile et régulière  
des cubes et losanges

Système  
cube breveté

## Mandoline Ultra Révolution

de Buyer  
MADE IN FRANCE  
MADE IN FRANCE

Multi-coupes de tous les fruits et légumes : cubes,  
losanges, tranches lisses ou dentelées, juliennes, coupes  
gauffrées. Epaisseur de tranches ultrafines jusqu'à 10 mm.  
Double-lame horizontale en acier coutelier.

Sécurité totale grâce au poussoir.  
Rangement compact.  
Châssis avec pieds repliables.  
3 peignes Julienne 2, 4 et 10 mm.

1010701P L. 50 x l. 18,5 x H. 18 cm - 1,54 kg

x 1 P.U.HT  
136,00 €

Encoche 90° pour  
guider la rotation  
lors des coupes  
cubes et gauffrés



Encoche 45° pour  
guider la rotation  
lors des coupes  
losanges et gauffrés



Support de lames  
Juliennes encastré

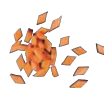

Salpicon

Brunoise

Matignon

Losange

Emincé

Rapé

Julienne

Frites

Ondulée

Gauffrée





## Mandoline japonaise



En plastique ABS et inox.  
Livrée avec : 1 lame plate inclinée pour tranches lisses, 3 lames effileuses 1, 3 et 6 mm pour les juliennes et coupes en bâtonnets et 1 poussoir de sécurité.  
Patins anti-dérapants.  
Poussoir de sécurité ergonomique pour bonne prise en main et sécurisation des doigts.

Largueur de coupe 65 mm  
**1010673** L. 32 x l. 11,5 x H. 3,5 cm - 390 g x 1 **P.U.HT 34,00 €**



Largueur de coupe 95 mm  
**1010672P** L. 36,5 x l. 14,5 x H. 4 cm - 610 g x 1 **P.U.HT 63,50 €**



## Mandoline



En acier inoxydable.  
Coupes obtenues sur le même appareil grâce aux systèmes de réglage incorporé.  
2 tailles d'effilage.  
Lame réversible.  
Appui bord de table (dispositif exclusif breveté).  
Faible encombrement.  
Position de travail naturelle grâce à son inclinaison idéale.  
Livrée sans chariot protecteur.  
L. 41 x l. 13,5 x H. 4,5 cm.

Mandoline sans chariot  
**3731** E 3 x 7 mm - Allumettes et pailles x 1 **120,00 €**  
**51411P** 3 x 10 mm. Frites et pailles. x 1 **107,00 €**

Accessoires  
**4700P** E Chariot de protection x 1 **30,75 €**  
**56487** E Couteau central pour mandoline x 1 **17,75 €**



## Rasoir à truffes



Le rasoir à truffe dispose d'une molette réglable pour trancher finement et réaliser des lamelles de truffes de différentes épaisseurs. Le rasoir à truffe permet aussi de trancher du parmesan, certaines variétés de champignons et autres petits légumes.

Râpe  
**1012542P** x 1 **P.U.HT 25,25 €**





## Diviseur à agrumes / tomates

Acier inoxydable et matériau composite.  
Jeu de lames et poussoirs interchangeables.  
Sécurité : aucun contact avec les lames.  
Dim. : L. 38 x l. 26 x H. 58 cm.

			P.U.HT
<b>31237</b>	12 quartiers	x 1	<b>169,00 €</b>
<b>31236P</b>	E 8 quartiers	x 1	<b>173,00 €</b>

## Coupe-agrumes / tomates en rondelles

Tranchage rapide avec précision et sécurité : 10 tranches de 5,5 mm.  
Grande stabilité sur le plan de travail grâce aux pieds ventouses.  
Facile à nettoyer. Poids 5,5 kg.

			P.U.HT
<b>1001002P</b>	E L. 42,5 x l. 20 x H. 18 cm	x 1	<b>304,00 €</b>

## Éplucheur légumes sur pied

Épluchage parfait. Aucune perte. Facile à nettoyer.

			P.U.HT
<b>51038</b>	E Concombres	x 1	<b>191,00 €</b>
<b>51037</b>	Carottes	x 1	<b>209,00 €</b>

Facile à utiliser: introduire les légumes par le haut puis tirer vers le bas. Gain de temps: 100 kg de carottes ou 600 concombres à l'heure.



Poussoir livré avec éplucheur carottes

## Coupe-légumes

Pour couper les légumes en fils continus. Chariot amovible et bâti en acier inoxydable, cassette porte-lames amovible en fonte d'aluminium alimentaire, lames en acier inoxydable. Livré avec 3 couteaux écartement 2, 3 et 6 mm, axe serre-joint et ventouses.

			P.U.HT
<b>35552</b>	L. 37 x l. 14 x H. 25 cm	x 1	<b>238,00 €</b>

## Coupe-frites professionnel

Socle lourd et stabilisateur en acier recouvert de peinture époxy.  
Débit : 4 à 5 kg/h. Livré prêt à l'emploi avec couteau et poussoir 8 mm.  
Poids 6,5 kg.

			P.U.HT
<b>34406P</b>	L. 44 x l. 25 x H. 33,5 cm	x 1	<b>277,00 €</b>
<b>Couteau et poussoir</b>			
<b>5621P</b>	6 mm	x 1	<b>37,50 €</b>
<b>5622P</b>	8 mm	x 1	<b>37,50 €</b>
<b>5623P</b>	10 mm	x 1	<b>37,50 €</b>
<b>5624P</b>	13 mm	x 1	<b>37,50 €</b>
<b>1007725</b>	20 mm - Frites Pont Neuf	x 1	<b>39,75 €</b>

## ESSOREUSES À SALADE



## Essoreuse à salade manuelle

En plastique alimentaire.

			P.U.HT
<b>43120P</b>	E 10 L (2 à 3 salades) Ø 33 x H. 42 cm	x 1	<b>131,00 €</b>
<b>34430P</b>	E 20 L (3 à 5 salades) Ø 43 x H. 50 cm	x 1	<b>157,00 €</b>

Premium

GARANTIE 1 an CE NF

## Ouvre-boîte électrique

Ouverture propre de toutes les boîtes de 50 à 270 mm (sans limailles). Hauteur réglable, assistée par ressort pneumatique. Percussion et ouverture en un seul mouvement. Lame réversible en acier inox. Jusqu'à 800 repas/jour, jusqu'à 80 boîtes 5x1 à la suite. Pignonnement métallique sur roulement à bille. A poser sur table.



OEXTC	
Matériau tige	inox
Matériau tête	inox
Dimension socle	45 x 25 cm
Dimensions	L. 45 x l. 25 x H. 67 cm
Poids	13,2 kg
Puissance	75 W
Alimentation	230 V
Caractéristique	2 vitesses
Référence	<b>54031 E</b>
P.U H.T	<b>1 450,00 €</b>

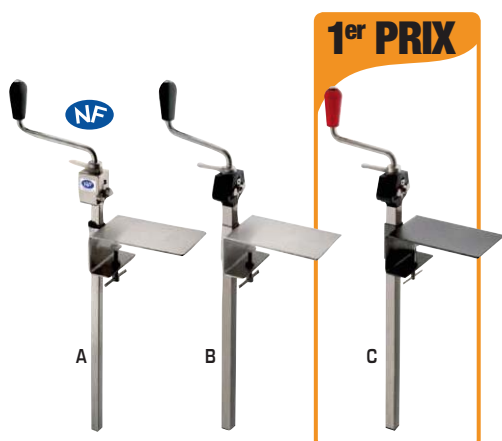

## Ouvre-boîte manuel

Ouverture propre de toutes les boîtes (sans limailles). Système mécanique simple et efficace, à pression réglable. Démontage facile pour le remplacement de la lame et de la molette. Lame en acier inox réversible (durée de vie double). Fixation mobile : système serre-joint à serrer sur le bord d'une table. Epaisseur maximum du support : 50 mm. Longueur tige : 55 cm.

	A - OXV55	B - OX5V55	C - O5V55
Matériau tige	inox	inox	acier
Matériau tête	inox	composite	composite
Dimension socle	22 x 12 cm	22 x 12 cm	22 x 12 cm
Poids	3,2 kg	2,8 kg	2,8 kg
Référence	<b>55497P E</b>	<b>38542P</b>	<b>42215P E</b>
P.U H.T	<b>360,00 €</b>	<b>157,00 €</b>	<b>90,00 €</b>

Bague rilsan

**56504P** x1

Lame de rechange

**7,00 €** **45121P** x1

Molette de rechange

**9,80 €** **45120P** x1

Kit de rechange

**28,50 €** **55498** x1 **38,00 €**



nouveau !



1er PRIX



## Ouvre-boîte

A - Ouvre-boîte titan

**67598P** x1 **32,25 €**

B - Ouvre-boîte à molette

**1013459P** x1 **7,50 €**

C - Ouvre-boîte junior

**2183P** x1 **1,40 €**

OUVRE-BOÎTES



CUISINE



## Pelle à poisson perforée

Inox

67683P L. 46 cm



P.U.HT  
15,75 €



## Pelle à poisson pleine

Inox

50137P L. 38 cm



P.U.HT  
13,50 €

Lacor



## Araignée

Inox. Branche pleine. Grille renforcée par une soudure.

67677P E Ø 14 - L. 56 cm  
71178P E Ø 18 - L. 57,5 cm  
71179P E Ø 20 - L. 63,2 cm  
71180P Ø 24 - L. 72,5 cm  
71181P Ø 28 - L. 78,5 cm

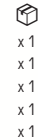

P.U.HT  
18,00 €  
24,25 €  
32,50 €  
38,00 €  
60,50 €



## Louche

Inox. Poignée ergonomique avec crochet.

Ep. 3 mm.

67663P Ø 6,5 cm - 7 cl  
67662P Ø 8 cm - 12 cl  
69304P Ø 10 cm - 25 cl  
1001422P Ø 12 cm - 36,2 cl  
1001421P Ø 16 cm - 99 cl

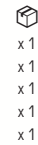

P.U.HT  
11,00 €  
13,90 €  
15,75 €  
21,50 €  
32,25 €

pro.cooker

1<sup>er</sup> PRIX



Ep. 1,2 mm.

69296P E Ø 6 cm - 7 cl  
69297P E Ø 8 cm - 12 cl  
69298P E Ø 10 cm - 25 cl  
69299P E Ø 12 cm - 50 cl  
69300P E Ø 14 cm - 75 cl  
69310P Ø 16 cm - 120 cl

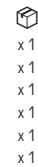

P.U.HT  
5,60 €  
6,70 €  
8,40 €  
11,90 €  
21,25 €  
25,50 €



## Ecumoire

Inox.

69289P Ø 8 cm  
69290P E Ø 10 cm  
69291P E Ø 12 cm  
69292P E Ø 14 cm  
69293P E Ø 16 cm  
69295P Ø 18 cm  
69294P Ø 20 cm

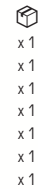

P.U.HT  
6,20 €  
7,00 €  
8,30 €  
13,90 €  
16,25 €  
27,00 €  
33,50 €



## Pochon à bec

Inox.

69301P Ø 6 cm - 6 cl



P.U.HT  
10,80 €



## Cuillère à sauce

Inox.

69288P L. 36 cm droite  
69287P L. 36 cm de côté



P.U.HT  
12,50 €  
12,50 €

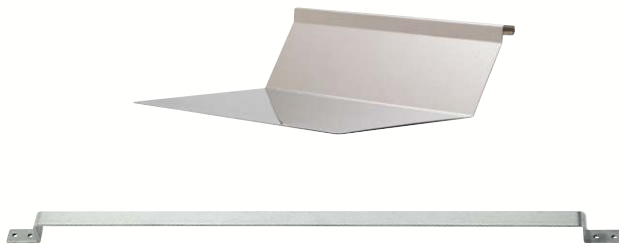

## Pelle à omelette

Inox.

38357P 30 x 28 cm



P.U.HT  
18,00 €

de Buyer

## Penderie cuisine

Inox.

45171 L. 79 cm



P.U.HT  
39,00 €

de Buyer





### Fourchette à viande

Inox. Manche ABS anti-glisse avec crochet.



49224 E L. 35 cm



x 1

P.U.HT

34,75 €



### Pelle de cuisson ajourée

En polyamide. Manche tube inox Ø 25 mm. 1 poignée de préhension ergonomique anti-glisse.



42183 E L. 35 cm



x 1

P.U.HT

70,00 €

42184 E L. 50 cm

x 1

73,00 €

42185 E L. 80 cm

x 1

82,50 €



### Louche

En polyamide. Manche tube inox Ø 25 mm. 1 poignée de préhension ergonomique anti-glisse.



42367 E L. 50 cm - 1,5 L



x 1

P.U.HT

102,00 €

42368 E L. 80 cm - 2 L

x 1

129,00 €



### Araignée carrée

Manche tube inox poli brossé, Ø 25 mm. 2 poignées en matériau composite alimentaire antibactérien. Crochet de suspension.



38360 L. 18 x l. 18 cm - 70 cm



x 1

P.U.HT

86,50 €

38361 E L. 22 x l. 22 cm - 74 cm

x 1

104,00 €

38362 E L. 26 x l. 26 cm - 76 cm

x 1

111,00 €

38363 E L. 30 x l. 30 cm - 80 cm

x 1

129,00 €



### Araignée ronde

Manche tube inox poli brossé Ø 25 mm. 2 poignées en matériau composite alimentaire antibactérien. Crochet de suspension.



55580 E Ø 22 cm - L. totale 74 cm



x 1

P.U.HT

104,00 €

55579 E Ø 26 cm - L. totale 76 cm

x 1

111,00 €

55578 E Ø 30 cm - L. totale 80 cm

x 1

129,00 €



### Fouet

Fils surmoulés. Manche tube inox poli brossé Ø 25 mm. Poignée en matériau composite alimentaire antibactérien. Crochet de suspension.



42025 E L. 40 cm



x 1

P.U.HT

54,00 €

42023P E L. 50 cm

x 1

57,00 €



### Fouet à purée rond

Fils surmoulés, renforcés Ø 4 mm. Manche tube inox poli brossé Ø 25 mm. Poignée en matériau composite alimentaire antibactérien. Crochet de suspension.



45172P E L. 120 cm



x 1

P.U.HT

163,00 €



### Spatule extra forte

En polyamide et inox. 2 poignées de préhension ergonomiques composite dont 1 avec crochet anti-glisse.



53144 E L. 120 cm



x 1

P.U.HT

106,00 €



### Spatule polyéthylène ajourée

Pour mélanger toutes sortes de préparations. Jusqu'à 220°C.

42364 E L. 100 cm



x 1

P.U.HT

127,00 €

1<sup>er</sup> PRIX



### Vide marmite

En inox. Peut être suspendu.



1002337 E Ø 20 x L. 43 cm - 2 L



x 1

P.U.HT

42,25 €



### Pochon

Tout inox. Poignée ergonomique composite avec crochet anti-glisse.



1005014 E Ø 20 x L. 40 cm - 2 L



x 1

P.U.HT

113,00 €



## Stop glisse®

Lame en acier inoxydable garantissant une totale anti-corrosion.

Manche polypropylène noir surmoulé, indémanchable et totalement étanche pour une hygiène parfaite et un lavage sans surprise en machine. Structure granitée pour une tenue en main irréprochable. Encoche pour maintenir l'outil accroché sur le bord des récipients, d'où l'appellation «Stop glisse». Sachet de 5 pastilles de couleurs : blanc, bleu, rouge, jaune et vert. Chaque pastille se glisse dans le trou du manche et permet de différencier les ustensiles en fonction de leur utilisation (viande, poisson, légumes ...).



Pelle à lasagnes

**45137P**Lame 15 cm  
Surface utile 11 x 8 cm**P.U. HT**  
**23,25 €**

Pelle large coudée

**35614P**
E Lame 15 cm.  
Surface utile 11 x 8 cm**P.U. HT**  
**14,40 €**

**35627P**
E Lame 28 cm.  
Surface utile 24 x 9 cm**P.U. HT**  
**43,25 €****35626**E Lame 35 cm.  
Surface utile 31 x 9 cm**P.U. HT**  
**63,00 €**

Cuillère de service ajourée

**50736P**

E L. totale 28 cm

**P.U. HT**  
**13,20 €**

**50733P**

E L. totale 33 cm

**P.U. HT**  
**13,20 €**

Cuillère de service pleine

**50734P**

L. totale 28 cm

**P.U. HT**  
**12,90 €**

**50735P**

E L. totale 33 cm

**P.U. HT**  
**12,40 €**

Louche à sauce

**69340P**

E 5 cl - L. totale 34 cm

**P.U. HT**  
**18,25 €****69341P**

E 14 cl - L. totale 36 cm

**P.U. HT**  
**21,25 €**

Fourchette diapason

**35628P**

L. totale 33 cm

**P.U. HT**  
**17,50 €**

Fourchette courbe 2 dents

**35629P**

E L. totale 32 cm

**P.U. HT**  
**13,80 €**

Fourchette courbe 3 dents

**45140**

L. totale 32 cm

**P.U. HT**  
**17,00 €**

Pelle à poisson

**1011126**Lame 33 cm  
Surface utile 20 x 6 cm**P.U. HT**  
**25,25 €**

Pelle à plancha

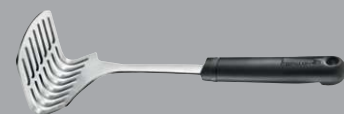
**1011127**Lame 27,1 cm  
Surface utile 16 x 12 cm**P.U. HT**  
**13,60 €**

Presse-purée

**1007381P**

E L. 26,4 x l. 6,6 cm

**P.U. HT**  
**15,00 €**

Premium

# Stop glisse®



**Pelle de service pleine**  
**35631P** E lame 15 cm  
L. totale 26 cm

x 1 **P.U. HT**  
**12,50 €**



**Pelle souple ajourée**  
**35634P** E lame 17 cm  
L. totale 28 cm

x 1 **P.U. HT**  
**12,30 €**



**Pelle de service à grille**  
**35632P** E lame 15 cm  
L. totale 26 cm

x 1 **P.U. HT**  
**12,50 €**



**Pelle de service à trous**  
**35633P** E lame 15 cm  
L. totale 26 cm

x 1 **P.U. HT**  
**12,50 €**



**Pelle à tarte unie**  
**45135P** lame 17 cm  
Surface utile 13 x 7,5 cm

x 1 **P.U. HT**  
**11,00 €**



**Pelle à tarte crantée**  
**45136** lame 17 cm  
Surface utile 13 x 7,5 cm

x 1 **P.U. HT**  
**20,75 €**



**Kit pastilles de couleur**  
**1007382P** E sachet de 5 couleurs panachées

x 1 **P.U. HT**  
**3,30 €**

1<sup>er</sup> PRIX

# Surclass®



Robuste et confortable. Lame inox et manche surmoulé.



**Pelle souple ajourée**  
**64533P** E lame 16 x 8 cm.  
L. totale 27,5 cm

x 1 **P.U. HT**  
**8,20 €**



**Pelle**  
**64534P** E lame 16 x 8 cm.  
L. totale 27,5 cm

x 1 **P.U. HT**  
**9,90 €**



**Cuillère ajourée**  
**64537P** E L. totale 31 cm

x 1 **P.U. HT**  
**8,10 €**



**Cuillère pleine**  
**64682P** E L. totale 31 cm

x 1 **P.U. HT**  
**9,50 €**



**Fourchette à servir**  
**64536** E L. totale 30,5 cm

x 1 **P.U. HT**  
**6,30 €**



**Pochon**  
**64535** E 5 cl - Ø 5 cm.  
L. totale 27,5 cm

x 1 **P.U. HT**  
**12,00 €**



**Louche**  
**64538P** E 10 cl - Ø 10 cm.  
L. totale 30 cm

x 1 **P.U. HT**  
**12,40 €**

USTENSILES STOP GLISSE / SURGLASS®



CUISINE

## Spatule droite lame crantée

Manche surmoulé. Lame souple en inox.



**45133** L. 30 cm

**P.U.HT**  
x 6 **28,75 €**

## Spatule droite

Manche surmoulé. Lame souple en inox.



**A - Spatule droite**

<b>67684P</b>	L. lame 14 cm	x 1	<b>P.U.HT</b>
<b>67685P</b>	L. lame 23 cm	x 1	<b>10,20 €</b>
			<b>12,20 €</b>

**B - Spatule droite**

<b>35606P</b>	E L. lame 25 cm	x 1	<b>P.U.HT</b>
<b>35605P</b>	E L. lame 30 cm	x 1	<b>12,00 €</b>
<b>35604P</b>	E L. lame 35 cm	x 1	<b>13,90 €</b>
			<b>17,25 €</b>

## Spatule coudée

Manche surmoulé. Lame inox.



<b>35613</b>	Surface utile 15 x 3,5 cm	x 6	<b>P.U.HT</b>
<b>35612</b>	Surface utile 19 x 4 cm	x 6	<b>15,25 €</b>
<b>705P</b>	E Surface utile 25 x 4 cm	x 1	<b>20,25 €</b>
<b>35611</b>	Surface utile 29 x 4 cm	x 6	<b>28,75 €</b>
			<b>27,25 €</b>



**45134** L. lame 16 cm

**P.U.HT**  
x 6 **7,80 €**

Manche en polypropylène.



**69363P** Surface utile 17 x 5 cm

**P.U.HT**  
x 1 **6,20 €**

## Palette triangle

Inox. Manche plastique.



**67686P** L. 10 cm

**P.U.HT**  
x 1 **11,40 €**

## Spatule pleine mélamine

En mélamine pour une résistance à des températures jusqu'à 225°C.



**62128P** L. totale 25 cm

**P.U.HT**  
x 1 **4,70 €**

## Spatule

Manche ABS et lame thermoplastique.



<b>1001468P</b>	L. 26 cm	x 1
<b>1001469P</b>	L. 36 cm	x 1
<b>1001470P</b>	L. 41 cm	x 1

Préparations  
froides

**P.U.HT**  
**3,80 €**  
**5,30 €**  
**7,30 €**

## Spatule silicone

Manche ABS et lame silicone.



<b>1001471P</b>	L. 25,5 cm	x 1
<b>1001472P</b>	L. 36 cm	x 1
<b>1001473P</b>	L. 40 cm	x 1

Préparations  
chaudes

**P.U.HT**  
**13,70 €**  
**17,25 €**  
**22,00 €**

## Spatule composite

Jusqu'à 250 °C. Cran d'appui anti-glisse.



<b>45441</b>	E L. 25 cm	x 25
<b>45442</b>	E L. 30 cm	x 25
<b>45443</b>	E L. 35 cm	x 25
<b>30348</b>	E L. 40 cm	x 25
<b>45444</b>	E L. 50 cm	x 25

Spécial haute  
température

**P.U.HT**  
**2,40 €**  
**3,00 €**  
**4,20 €**  
**5,10 €**  
**7,60 €**

## 1<sup>er</sup> PRIX Spatule bois



<b>35094P</b>	L. 35 cm	x 1	<b>P.U.HT</b>
<b>2456</b>	L. 60 cm	x 5	<b>2,80 €</b>
<b>2458</b>	L. 100 cm	x 2	<b>6,50 €</b>
<b>35097</b>	L. 150 cm	x 1	<b>23,50 €</b>
			<b>39,00 €</b>

## Cuillère bois



**2449** L. 35 cm

**P.U.HT**  
x 10 **2,20 €**

## Fouet spécial blanc

Inox. Forme boule, crochet anti-glisse.



<b>35103</b>	L. 37 cm	x 1	<b>P.U.HT</b>
<b>35104</b>	L. 50 cm	x 1	<b>26,50 €</b>
			<b>31,50 €</b>

## Fouet sauces et cocktails

Inox.



**35649** L. 13 cm

**P.U.HT**  
x 6 **8,90 €**

## Fouet contact

Flex système.



<b>38528</b>	E L. 25 cm	x 1	<b>P.U.HT</b>
<b>38529</b>	E L. 30 cm	x 1	<b>12,50 €</b>
<b>38530</b>	E L. 35 cm	x 1	<b>13,60 €</b>
<b>38531</b>	E L. 40 cm	x 1	<b>13,80 €</b>
<b>38532</b>	E L. 45 cm	x 1	<b>14,30 €</b>
			<b>15,75 €</b>

## 1<sup>er</sup> PRIX Fouet

Manche tube inox, montage étanche avec obturation en acier inoxydable. Fouet 25 - 30 - 35 cm composés de 12 fils en acier inoxydable Ø 1,4 mm. Fouet 40 et 50 cm composés de 8 fils en acier inoxydable Ø 2,3 mm.



<b>42122</b>	E L. 20 cm	x 1	<b>P.U.HT</b>
<b>65259P</b>	E L. 25 cm	x 1	<b>5,70 €</b>
<b>65258P</b>	E L. 30 cm	x 1	<b>9,10 €</b>
<b>65260P</b>	E L. 35 cm	x 1	<b>10,30 €</b>
<b>65261P</b>	E L. 40 cm	x 1	<b>11,30 €</b>
<b>65262P</b>	E L. 50 cm	x 1	<b>15,25 €</b>
			<b>17,50 €</b>







## Pince embout nylon

Inox. Ne raye pas les plats et atténue le bruit. Résiste à 210°C.



Code	Longueur	Quantité	P.U. HT
57730P	L. 30 cm	x 1	5,90 €
57248P	L. 40,5 cm	x 1	7,50 €

## 1<sup>er</sup> PRIX

### Pince inox



Code	Longueur	Quantité	P.U. HT
1029P	E L. 23 cm	x 1	3,60 €
1030P	E L. 40 cm	x 1	7,40 €

### Pince Acétal

Jusqu'à 100 °C.



Code	Longueur	Quantité	P.U. HT
1006614P	L. 23 cm	x 1	3,80 €
63345P	L. 23 cm	x 1	3,80 €
63347P	L. 30,5 cm	x 1	5,60 €

### Pince anti-microbien

Inox avec manche traitement anti-bactérien.



Code	Longueur	Quantité	P.U. HT
1006364P	E L. 15,2 cm	x 1	6,40 €
1006367P	L. 24 cm	x 1	8,30 €
1006368P	E L. 30,5 cm	x 1	8,80 €

Code	Longueur	Quantité	P.U. HT
1006362P	E L. 15,2 cm	x 1	6,40 €
65461P	E L. 24 cm	x 1	8,10 €

Code	Longueur	Quantité	P.U. HT
1006363P	E L. 15,2 cm	x 1	6,40 €
65463P	E L. 24 cm	x 1	8,30 €

Code	Longueur	Quantité	P.U. HT
1006365P	E L. 15,2 cm	x 1	6,40 €
65462P	E L. 24 cm	x 1	8,10 €

Code	Longueur	Quantité	P.U. HT
1006366P	E L. 15,2 cm	x 1	6,40 €
65464P	E L. 24 cm	x 1	8,30 €

Il est facile d'imaginer le nombre de microbes nuisibles qui peuvent être transférés aux ustensiles de cuisson et de service. Utilisez le pouvoir de la technologie antimicrobienne aux ions argent Agion®, une exclusivité Vollrath. Alors que les surfaces non traitées permettent aux microbes de se rassembler et de se multiplier, les ions argent des ustensiles antimicrobiens de Vollrath les attaquent !



## 1<sup>er</sup> PRIX

### Pince

En acier inoxydable avec manche plastique de couleur.



Code	Longueur	Quantité	P.U. HT
71183P	E Vert	x 1	7,80 €
71182P	E Bleu	x 1	7,80 €
71185P	E Rouge	x 1	7,80 €
71184P	E Marron	x 1	7,80 €



## 1<sup>er</sup> PRIX

### Fourchette diapason

Inox brossé. 2 dents droites. Manche composite.

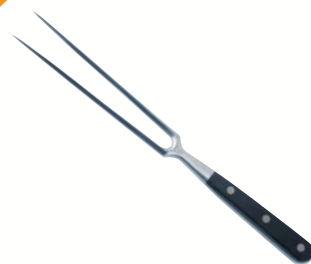

Code	Longueur	Quantité	P.U. HT
54605P	E L. 32 cm	x 1	19,75 €

### Rack porte-outils mural

Inox. Support 5 x 2 crochets.



Code	Longueur	Quantité	P.U. HT
45611	E L. 39 cm	x 1	25,00 €

## DRESSAGE DE PRÉCISION

### Spatule coudée

Inox.



Code	Longueur	Quantité	P.U. HT
1005737P	E L. lame 12 cm	x 1	10,90 €

### Plateau à dresser

Inox.



Code	Dimensions	Quantité	P.U. HT
1007724P	L. 26 x l. 18,5 x H. 2 cm	x 1	11,80 €

## nouveau !

### Cuillère plume

Inox. Pour écrire comme avec un stylo.



Code	Contenu	Quantité	P.U. HT
1013430P	Coffret de 2 : 1 grande + 1 petite	x 1	24,25 €

### Pince de dressage

Inox.

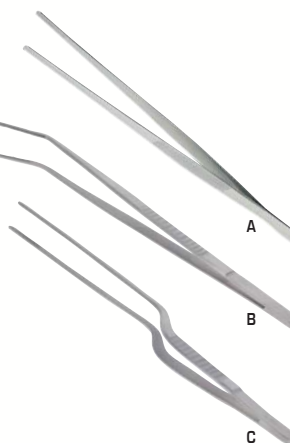

Code	Longueur	Quantité	P.U. HT
1006426P	L. 30 cm	x 1	7,90 €

Code	Longueur	Quantité	P.U. HT
1010694P	L. 16 cm	x 1	4,60 €

Code	Longueur	Quantité	P.U. HT
1010695P	L. 30 cm	x 1	11,10 €





## Passes-bouillon

Inox.

			P.U.HT
45302	Ø 8 cm	24	5,70 €
45303	Ø 10 cm	1	7,40 €
45304	Ø 12 cm	1	9,70 €
45305	Ø 14 cm	1	11,20 €
45306	Ø 16 cm	1	13,10 €
45307	E Ø 18 cm	1	15,75 €
45308	E Ø 20 cm	1	19,75 €

Lacor

nouveau !



## Passoire Stop Glisse®

Tamis en acier inoxydable. Maillage serré.

DÉGLON

			P.U.HT
1013383P	Ø 8 cm	x 1	6,70 €
1013384	Ø 14 cm	x 6	12,20 €
1013385P	Ø 20 cm	x 1	15,50 €



## Passoire chinois

Inox. Fines piqûres.

Lacor

			P.U.HT
464	E Ø 20 cm	x 1	27,25 €
465	E Ø 24 cm	x 1	31,25 €



## Passoire chinois

Inox. Fines piqûres, sans mailles.

			P.U.HT
67671P	E Ø 18 cm	x 1	18,25 €
67672P	Ø 20 cm	x 1	21,25 €
1001419P	E Ø 21 cm	x 1	27,00 €
67673P	Ø 24 cm	x 1	24,75 €

nouveau !



## Egouttoir à fritures

Inox. Avec poignée et panier récupérateur amovible.

			P.U.HT
1012715	E Ø 39 x H. 18 cm	x 1	67,50 €



## Passoire conique

Inox. Qualité professionnelle.

			P.U.HT
1005087P	E Ø 24 cm	x 1	60,50 €
1005086P	E Ø 28 cm	x 1	72,50 €



## Passoire à gras avec pieds MAUVIEL 1830.

Aluminium. 3 pieds, 2 poignées. Passe au lave-vaisselle.

			P.U.HT
54178P	Ø 40 cm	x 1	117,00 €



## Passoire conique

Inox. Qualité professionnelle: solide et résistante.

			P.U.HT
67668P	Ø 32 cm	x 1	57,50 €
67669P	Ø 36 cm	x 1	69,50 €
67670P	E Ø 40 cm	x 1	80,00 €
64728	Ø 44 cm	x 1	98,50 €
64729P	E Ø 48 cm	x 1	101,00 €

## MOULINS

### Moulin

Inox. S'adapte sur tous récipients cylindriques (Ø supérieur à 18 cm).



Moulin semi-professionnel X3 livré avec 3 disques (1,5 / 2,5 / 4 mm)

✓ **4034P** Ø 31 cm x 1 **P.U.HT** 103,00 €

Moulin professionnel X530 livré avec 1 grille 3 mm.

✓ **51035P** E Ø 37 cm x 1 **P.U.HT** 250,00 €

Grille seule

Code	Grille	Qté	P.U.HT
55495	1 mm	1	69,50 €
55500	1,5 mm	1	69,50 €
55493	2 mm	1	69,50 €
55491	E 3 mm	1	69,50 €
55489	4 mm	1	69,50 €

### Entonnoir avec filtre

Inox.



✓ **1001420P** Ø 15 x H. 12,1 cm x 1 **P.U.HT** 22,25 €

### Entonnoir



Code	Couleur	Dimensions	Qté	P.U.HT
55577	Blanc	Ø 12 x H. 12 cm	x 1	2,00 €
55575		Ø 14 x H. 14 cm	x 1	2,50 €
55576		Ø 16 x H. 16 cm	x 1	2,90 €
55574		Ø 20 x H. 20 cm	x 1	3,50 €

## 1er PRIX



✓ **49054P** Bleu Ø 14 cm x 1 **P.U.HT** 1,70 €

## ENTONNOIRS



### Entonnoir à piston

Inox. Buse 15 mm afin de ne pas casser les molécules d'air et préserver l'effet mousseux des préparations.

de Buyer

✓ **1001012** Ø 20 x H. 38 cm x 1 **P.U.HT** 173,00 €



### Entonnoir à piston

Tout inox. 3 débits. Livré avec 2 douilles 4 et 6 mm.

de Buyer

✓ **38353P** Entonnoir sans support E Ø 19 x H. 18 cm x 1 **P.U.HT** 114,00 €

✓ **38354P** Support pour entonnoir E x 1 **P.U.HT** 17,25 €



### Mini-entonnoir à piston

Corps inox poignée plastique. Ce mini entonnoir possède un débit de 7 mm et est parfaitement étanche. Buse 7 mm.

de Buyer

✓ **64180P** Ø 15 x H. 15,5 cm x 1 **P.U.HT** 58,00 €

## MESURES



### Mesure graduée

Inox avec pied et poignée.

Code	Capacité	Qté	P.U.HT
67661P	E 1 L	x 1	20,00 €
34284	E 1,5 L	x 1	29,00 €
34285	E 2 L	x 1	34,25 €



### Broc mesure gradué

Gerbable. Graduation en ml et en litre.

PP **thermo hauser**

Code	Capacité	Qté	P.U.HT
55196P	E 1 L	x 1	5,70 €
55197P	E 2 L	x 1	11,10 €
55198	E 3 L	x 12	14,70 €

## DÉBARASSAGE



### Plaque à débarasser

En inox.

de Buyer

Code	Dimensions	Qté	P.U.HT
60669P	L. 30 x l. 25 x H. 4,3 cm	x 1	24,00 €
60670P	L. 35 x l. 27 x H. 4,6 cm	x 1	29,25 €
60671P	L. 42 x l. 32 x H. 5 cm	x 1	33,00 €



### Bahut à débarasser

INOX 18/10

Code	Dimensions	Qté	P.U.HT
61521P	Ø 16 x H. 13,5 cm x 1	x 1	42,50 €
61522P	Ø 20 x H. 17 cm x 1	x 1	59,00 €
61523P	Ø 24 x H. 20 cm x 1	x 1	77,00 €
61524P	Ø 28 x H. 23,5 cm x 1	x 1	109,00 €





## Plaque aluminium

de Buyer

Aluminium sans revêtement. Ep. 1,5 mm. Bords pincés 45°.

Pleine			P.U.HT
1002756P	GN 1/1 L. 53 x l. 32,5 cm	x 1	14,70 €
1002758P	Pâtisserie L. 60 x l. 40 cm	x 1	16,50 €
62038P	L. 40 x l. 30 cm	x 5	14,80 €



Perforée			P.U.HT
51021	GN 1/1 L. 53 x l. 32,5 cm	x 1	21,25 €
51020	Pâtisserie L. 60 x l. 40 cm	x 1	21,50 €



## Plaque tôle d'acier noire

de Buyer

Ep. 1,2 mm.

Bords droits. H. 2 cm			P.U.HT
3632	GN 1/1. L. 53 x l. 32,5 cm	x 1	20,75 €
3634	Pâtisserie. L. 60 x l. 40 cm	x 1	27,00 €

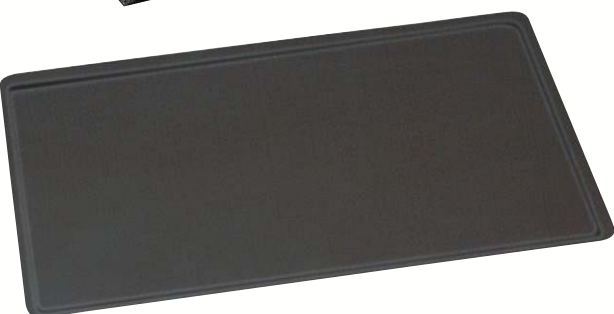

Bords pincés. H. 1 cm			P.U.HT
48347P	E GN 1/1 L. 53 x l. 32,5 cm	x 1	8,60 €
48346P	E Pâtisserie L. 60 x l. 40 cm	x 1	10,60 €



## Plaque inox

de Buyer

Bords pincés. Ep. 1 mm.

			P.U.HT
54451	E GN 1/1 L. 53 x l. 32,5 cm	x 1	23,75 €
54450	E Pâtisserie L. 60 x l. 40 cm	x 1	24,00 €
54452	E GN 2/1 L. 65 x l. 53 cm	x 1	40,50 €



## Plaque aluminium anti-adhésive

Bords pincés 45°. Ep. 2 mm.

			P.U.HT
70146P	E GN 1/1 L. 53 x l. 32,5 cm	x 1	31,00 €
70203P	E Pâtisserie L. 60 x l. 40 cm	x 1	37,00 €
1002757	GN 2/1 L. 65 x l. 53 cm	x 1	32,75 €



Stockage 

## Grille plate de stockage

Format GN

**65203P** E GN 1/1 - L. 53 x l. 32,5 cm - 2 traverses  
Ø 5 mm - 20 fils Ø 2 mm - Inox

 x 1 **P.U.HT**  
**9,00 €**

**65204P** E GN 2/1 - L. 65 x l. 53 cm - 3 traverses  
Ø 7 mm - 20 fils Ø 3 mm - Inox

 x 1 **P.U.HT**  
**16,25 €**

**4037** E GN 2/1 - L. 65 x l. 53 cm - 3 traverses  
Ø 7 mm - 32 fils Ø 3 mm - Acier chromé

 x 1 **P.U.HT**  
**21,00 €**

Format pâtissier

**65205P** E 60 x 40 cm - 3 traverses  
Ø 5 mm - 29 fils Ø 2 mm - Inox

 x 1 **P.U.HT**  
**9,90 €**

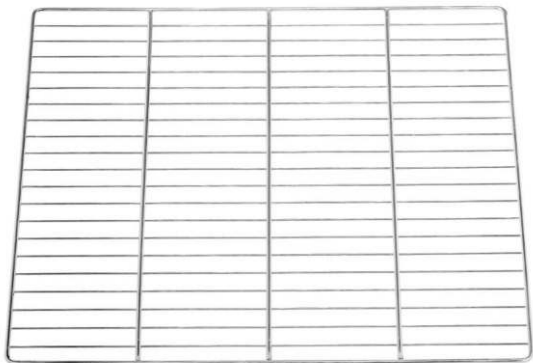

Cuisson 

## Grille de cuisson renforcée "spécial four"

Inox.

**4043** 2 traverses Ø 7 mm - 20 fils  
Ø 3 mm. GN 1/1 L. 53 x l. 32,5 cm

 x 1 **P.U.HT**  
**27,00 €**

**4042** 3 traverses Ø 10 mm - 15 fils  
Ø 4 mm. GN 2/1 L. 65 x l. 53 cm

 x 1 **P.U.HT**  
**72,00 €**

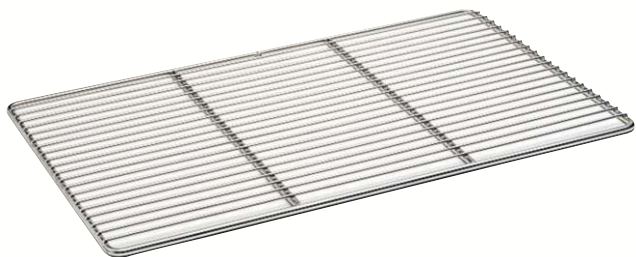

Gants anti-  
chaleur,  
voir page 426



## Toile de cuisson surgélation

Conçue pour de multiples usages et plus spécialement pour la viennoiserie-pâtisserie, le travail du sucre. Application d'un revêtement anti-adhérent silicone. A utiliser de préférence sur des plaques grandes perforations. Très résistantes. Entretien facile (nettoyage à l'eau claire avec une éponge douce). De -40°C à + 280 °C max.



Pour format pâtissier 60 x 40 cm  
**1001550P** Dimensions Toile : 58,5 x 38,5 cm

 x 1 **P.U.HT**  
**26,25 €**

Pour format GN1/1 53 x 32,5 cm  
**1001551P** E Dimensions Toile : 52 x 31,5 cm

 x 1 **P.U.HT**  
**19,25 €**



## Plaques à tuiles

Inox, 6 gouttières.



**45359** L. 35 x l. 32 x H. 2,5 cm

 x 1 **P.U.HT**  
**62,00 €**





## Rouleau pic-vite

En plastique.

67601P L. 12,5 cm

x 1

P.U.HT  
10,30 €



## Roulette à pâte inox unie

Manche polypropylène.

35183 Ø 4 cm

x 12

P.U.HT  
7,20 €



## Roulette à pâte inox cannelée

Manche polypropylène.

39263 Ø 4 cm

x 1

P.U.HT  
7,10 €



## Roller pâte

Inox. Manche polypropylène.

51776 Ø 6 cm

x 12

P.U.HT  
13,10 €



## Corne

2485P E L. 12 x l. 9,5 cm

x 1

P.U.HT  
1,70 €



## Raclette coupe-pâte arrondie

Inox et manche en plastique.

30356 L. 11 x l. 10 cm

x 1

P.U.HT  
3,10 €



## Raclette coupe-pâte carrée

Inox et manche plastique.

30355 L. 11 x l. 10 cm

x 1

P.U.HT  
3,10 €



## Pelle à ingrédients

Aluminium. Robuste et maniable.

70418

L. 18 x l. 6,6 cm

x 1

P.U.HT  
2,70 €

70417

L. 21 x l. 7,1 cm

x 1

3,50 €

70416

L. 26,5 x l. 9,6 cm

x 1

5,30 €

70415P

L. 31 x l. 11,3 cm

x 1

7,60 €

70414

L. 40 x l. 15,7 cm

x 1

14,30 €

70413

L. 43 x l. 18,5 cm

x 1

22,00 €



## Noyaux de cuisson

Aluminium. Idéal pour la cuisson des fonds de tarte.

Boîte de 1 kg

70410

x 1

P.U.HT  
17,25 €



## Brosse à pétrin

Bois + soie noire.

70408

L. 21 x H. 7,5 cm

x 1

P.U.HT  
8,40 €



## Brosse boulangère

1/2 tête, soie blanche. Permet d'éliminer l'excédent de farine lors du travail des pâtes.

49737P

L. totale 33 cm

x 1

P.U.HT  
17,00 €



## Saupoudreuse

En inox. Fine piqûre.

45513P

Ø 7 x H. 9,5 cm

x 1

P.U.HT  
8,30 €



## Rouleau à pâtisserie

Sans poignée.

71235P

E L. 50 cm x Ø 5 cm

x 1

P.U.HT  
38,75 €



## Rouleau à pâtisserie

En hêtre.

31001P

L. 50 cm x Ø 5 cm

x 1

P.U.HT  
10,60 €



## Volette à pieds

Inox.

1002141P

Ø 32 x H. 2 cm

x 1

P.U.HT  
18,00 €





## Pinceau silicone

de Buyer

Spécialement conçu pour une utilisation en pâtisserie comme en cuisine.

			P.U. HT
68631P	E L. 19,5 x l. 3 cm	x 1	5,90 €
1010700	L. 25 x l. 4,5 cm	x 1	9,30 €

## Pinceau pâtissier



Virole plastique. Manche composite et poils en soie naturelle.

			P.U. HT
62118P	L. poils 6 cm x 14 cm	x 1	5,00 €

1<sup>er</sup> PRIX

## Pinceau pâtissier

Virole galvanisée. Manche en polypropylène et soies blanches cuites.

			P.U. HT
49792P	E L. poils 3 cm	x 1	2,20 €
49791P	E L. poils 4 cm	x 1	2,90 €

## Douille inox

de Buyer

Solide, sans soudure. Marquage de la douille pour une identification facile. Ø 3,8 x L 5,2 cm.



Lot de 6  
1 douille bûche plate, 2 douilles unies  
2 et 9 mm, 2 douilles 6 dents 4 et 6 mm,  
1 douille 8 dents 6 mm

			P.U. HT
1010696P	E	x 1	12,40 €

## Douille copolyester

Couleur bleue pour la repérer facilement dans la crème ou dans la plonge.



Lot de 6  
Douilles unies : u4, u5, u6, u8, u10 et u12

			P.U. HT
49566P	E La boîte de 6	x 1	12,70 €



Lot de 6  
Douilles cannelées : c8, d8, e8, f8, c6 et d6

			P.U. HT
49414P	E La boîte de 6	x 1	12,70 €



Lot de 24  
Douilles pâtisseries :  
10 douilles unies,  
12 douilles cannelées,  
1 douille bûche  
8 dents et  
1 douille feuille

			P.U. HT
63375P	E La boîte de 24	x 1	37,50 €

## Poche nylon



Qualité professionnelle : extra-souples et lavables.

			P.U. HT
37534P	L. 34 cm	x 6	4,30 €
37536P	L. 40 cm	x 6	5,40 €
37537P	L. 45 cm	x 6	6,60 €



## Poche jetable

Poches souples jetables, antiglissantes et résistantes.

En polyéthylène basse densité. Ep. 85µ.

Boîte distributrice de 200 poches

			P.U. HT
49409P	H. 54 cm	x 1	43,25 €



## Poche jetable

Poche à douille jetable en polyéthylène basse densité. Ep. 70 µ.

			P.U. HT
Paquet de 100			
68559P	E 30 x H. 54 cm	x 1	14,60 €
1013372P	30 x H. 54 cm	x 10	17,25 €



## Piston à pression Le Tube

de Buyer

Travail facile, rapide, précis et soigné. Livré avec 2 douilles.

Douille démontable et interchangeable.

			P.U. HT
Contenance 0,75 L			
71196	Piston à pression L. 38,4 x l. 10,5 cm	x 1	94,00 €
71197	Recharge L. 19,6 x l. 8,5 cm	x 1	10,40 €



## Présentoir 5 étages

En plastique blanc. Plateaux de 20,25,32,40 et 44 cm. Entretoise de 16 cm.

			P.U. HT
4202	H. 71 cm	x 1	46,00 €



## Siphon

KAYSER

Corps inox brossé et tête massive en inox pour une hygiène parfaite ! Consomme une cartouche pour 50 cl de liquide. Livré sans cartouche.

Pour préparations froides et chaudes

Tout inox

			P.U. HT
Siphon			
1000179P	0,5 L	x 1	86,50 €
1000178P	1 L	x 1	91,50 €

Blister pièces détachées (Adaptateur + douille + soupape + joint).

			P.U. HT
63681P		x 1	20,50 €
Boîte de 24 cartouches d'azote			
63680P		x 1	11,20 €



## Bassine à fond silicone

de Buyer

Inox. Stable grâce à sa base antidérapante. Bord roulé ouvert. Graduée.



			P.U. HT
1010697	Ø 20 x H. 10 cm - 2 L	x 1	18,50 €
1010698P	Ø 24 x H. 11 cm - 3,5 L	x 1	28,25 €
1010699	Ø 28 x H. 12,5 cm - 5,5 L	x 1	27,00 €

## Bassine 1/2 sphérique

INOX 18/10

Intérieur poli.



			P.U. HT
45309	Ø 22 x H. 12 cm - 2,7 L	x 1	27,25 €
61525P	E Ø 24 x H. 12,5 cm - 3,6 L	x 1	37,75 €
61526P	E Ø 30 x H. 15 cm - 7 L	x 1	46,25 €
61527P	E Ø 35 x H. 17,5 cm - 11 L	x 1	62,00 €
61528P	E Ø 40 x H. 20 cm - 16,8 L	x 1	81,00 €

## Bassine à fond plat

En inox. Bord ouvert demi-rond, facile à nettoyer.

PRO-COOKER



			P.U. HT
67653P	E Ø 20 x H. 9 cm - 2 L	x 1	12,10 €
67654P	E Ø 24 x H. 11 cm - 2,5 L	x 1	17,00 €
67655P	E Ø 28 x H. 13 cm - 4,5 L	x 1	21,00 €

			P.U. HT
45321P	E Ø 32 x H. 14 cm - 8,2 L	x 1	24,50 €
45322P	E Ø 36 x H. 15 cm - 11,5 L	x 1	28,00 €
45323P	E Ø 40 x H. 17,5 cm - 16 L	x 1	36,50 €

de Buyer

P.U. HT

## 1<sup>er</sup> PRIX



## Cul de poule plastique

thermo hauser PP POLYPROPYLENE

			P.U. HT
55201P	E Ø 32 x H. 14,5 cm - 6 L	x 1	8,80 €
55199P	E Ø 40 x H. 18 cm - 13 L	x 1	14,30 €

## Tamis

Inox. Toile fixe.



			P.U. HT
67638P	Ø 26 cm Maille n° 20	x 1	56,50 €
67674P	Ø 29 cm Maille n° 20	x 1	90,50 €
52508	Ø 30 cm Maille n° 35	x 1	54,50 €

## Poêlon à sucre

Cuivre.

MAUVIEL 1830.



			P.U. HT
45332	Ø 16 x H. 9 cm - 1,8 L	x 1	92,00 €



## Fer à caraméliser électrique

GARANTIE 1 an CE

Comprend une plaque en fonte. Puissance 800 W. 220/230 V. Poignée en plastique. Livré avec support mural en acier chromé.

			P.U. HT
38776	Ø 11,5 cm - L. 35 cm	x 1	164,00 €

## 1<sup>er</sup> PRIX



## Fer à caraméliser à allumage automatique

Allumage automatique piezo. Très grande finesse de réglage. Prise en main ergonomique. Brûleur laiton hautes performances. Connexion cartouche de gaz à valve simple, rapide et sûre. Livré sans cartouche de gaz.

			P.U. HT
64274P	15,5 x 14 x 18 cm	x 1	63,50 €
64275P*	A valve - 24 g	x 6	8,10 €

\* Dangereux. Respecter les précautions d'emploi. Produit conforme à la législation française.







## Moule souple silicone GN 1/3



En silicone flexible avec effet anti-adhésif.  
Format GN 1/3 (17,5 x 29,5 cm). Température maximum : -40°C + 230°C. Répondant aux normes alimentaires.



15 petits fours ronds  
✓ **1002303P** Ø 4 x H.2 cm

**P.U.HT**  
x 1 **11,90 €**



24 petits fours ronds  
✓ **1002304P** E Ø 3,4 x H. 1,6 cm

**P.U.HT**  
x 1 **11,90 €**

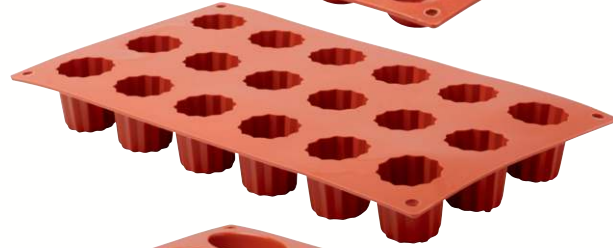

18 mini-cannelés bordelais  
✓ **1002306P** E Ø 3,5 x H. 3,5 cm

**P.U.HT**  
x 1 **11,90 €**



16 petits fours ovales  
✓ **1002302P** E L.5,3 x l.3,3 x H.2 cm

**P.U.HT**  
x 1 **11,90 €**



15 mini-tartelettes  
✓ **1002305P** E Ø 4,5 x H. 1 cm

**P.U.HT**  
x 1 **11,90 €**



15 tartelettes  
**1002301P** E Ø 5 x H. 1,5 cm

**P.U.HT**  
x 1 **11,90 €**



15 mini-madeleines  
✓ **1002299P** E L.4,4 x l.3,4 x H.1 cm

**P.U.HT**  
x 1 **11,90 €**



6 demi-sphères  
✓ **1002307P** E Ø 7 x H. 3,5 cm

**P.U.HT**  
x 1 **11,90 €**

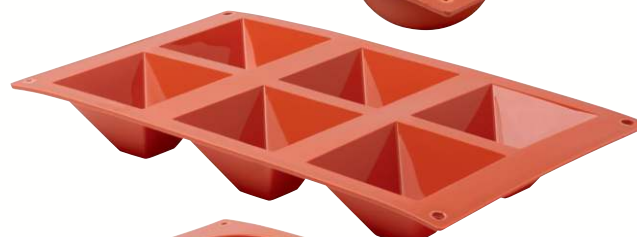

6 pyramides  
✓ **1002308P** E L. 7,1 x l.7,1 x H. 4 cm

**P.U.HT**  
x 1 **11,90 €**



6 muffins  
✓ **1002300P** E Ø 6,9 x H.3,5 cm

**P.U.HT**  
x 1 **11,90 €**



Anti-adhésif, 4 atouts :  
Évite toute oxydation.  
Facilite le nettoyage : n'attache pas, les aliments cuits ne restent pas collés.  
Facilite le démoulage. Graissage des moules inutile dans de nombreuses utilisations.  
Un léger graissage à la bombe vous donnera un démoulage parfait.



## Millasson

Rond uni, bordé, anti-adhésif.



<b>39135</b>	Ø 8 x H. 1,8 cm	x 25	<b>P.U.HT</b> <b>2,10 €</b>
<b>39137</b>	Ø 10 x H. 2,1 cm	x 12	<b>2,60 €</b>



## Savarin individuel débouché

Anti-adhésif.



<b>52615</b>	Ø 7 x H. 1,7 cm	x 25	<b>P.U.HT</b> <b>2,60 €</b>
<b>52616</b>	Ø 8 x H. 2 cm	x 25	<b>2,80 €</b>



## Dôme à côtes

Anti-adhésif.



<b>35336</b>	Ø 4,5 cm	x 25	<b>P.U.HT</b> <b>0,66 €</b>
--------------	----------	------	--------------------------------



## Tartelette ronde cannelée

Anti-adhésif.



<b>52601</b>	Ø 6 x H. 1 cm	x 25	<b>P.U.HT</b> <b>1,10 €</b>
<b>52603</b>	Ø 8 x H. 1,2 cm	x 25	<b>1,40 €</b>
<b>52606</b>	Ø 12 x H. 2 cm	x 25	<b>2,30 €</b>



## Tartelette ronde unie

Anti-adhésif.



<b>52621</b>	Ø 5 x H. 1,1 cm	x 25	<b>P.U.HT</b> <b>1,10 €</b>
<b>52617</b>	Ø 6 x H. 1,2 cm	x 25	<b>1,20 €</b>
<b>52619</b>	Ø 9 x H. 1,2 cm	x 25	<b>1,80 €</b>
<b>52620</b>	Ø 10 x H. 1,2 cm	x 25	<b>2,00 €</b>



## Moule Dariole

Inox.



<b>1005089P</b>	Ø 4,5 x H. 4,5 cm	x 1	<b>P.U.HT</b> <b>6,10 €</b>
<b>Paquet de 6</b>			<b>P.U.HT</b>
<b>1005090P</b>	Ø 5,5 x H. 5,5 cm	x 1	<b>37,75 €</b>



## Dariole

Anti-adhésif. Spéciale baba.



<b>35353</b>	Ø 6 x H. 6 cm	x 25	<b>P.U.HT</b> <b>3,90 €</b>
--------------	---------------	------	--------------------------------



## Aspic ovale

Anti-adhésif.



<b>56121</b>	L. 7,5 x H. 3,8 cm	x 25	<b>P.U.HT</b> <b>2,80 €</b>
--------------	--------------------	------	--------------------------------



## Brioche 10 côtes

Anti-adhésif. Fond plat. Grosses côtes.



<b>35357</b>	Ø 8 x H. 3,2 cm	x 25	<b>P.U.HT</b> <b>1,60 €</b>
<b>35358</b>	Ø 9 x H. 3,5 cm	x 25	<b>1,70 €</b>
<b>35359</b>	Ø 10 x H. 4,2 cm	x 25	<b>1,80 €</b>





## Tourtière cannelée fond mobile

BRANITE 100%  
**GOBEL**  
LA BIEN-ÊTRE DES CUISINIÈRES

Anti-adhésif.

			P.U. HT
35325	∅ 20 x H. 2,5 cm	x 6	7,90 €
35326	∅ 24 x H. 2,5 cm	x 6	11,00 €
35327	∅ 28 x H. 2,5 cm	x 6	14,40 €
35328	∅ 32 x H. 2,5 cm	x 6	17,50 €



## Tourtière cannelée fond fixe

BRANITE 100%  
**GOBEL**  
LA BIEN-ÊTRE DES CUISINIÈRES

Anti-adhésif.

			P.U. HT
45364	∅ 20 x H. 2,5 cm	x 6	5,30 €
45365	∅ 24 x H. 2,5 cm	x 6	7,10 €
45366	∅ 26 x H. 2,5 cm	x 6	7,90 €
45367P	∅ 28 x H. 2,5 cm	x 1	9,40 €
45368	∅ 30 x H. 2,5 cm	x 6	9,70 €
45369P	∅ 32 x H. 2,5 cm	x 1	11,70 €



## Brioche 14 côtés fond plat

BRANITE 100%  
**GOBEL**  
LA BIEN-ÊTRE DES CUISINIÈRES

Anti-adhésif.

			P.U. HT
38756	∅ 14 x H. 4,8 cm	x 6	4,10 €
38757	∅ 16 x H. 5,5 cm	x 6	5,00 €
38758	∅ 18 x H. 5,6 cm	x 6	5,70 €
38759	∅ 20 x H. 7,2 cm	x 6	7,90 €
38760	∅ 22 x H. 8,7 cm	x 6	10,50 €



## Moule à savarin

BRANITE 100%  
**GOBEL**  
LA BIEN-ÊTRE DES CUISINIÈRES

Anti-adhésif.

			P.U. HT
52598	∅ 22 x H. 5,8 cm	x 6	13,00 €
52599P	∅ 24 x H. 5,8 cm	x 6	14,50 €



## Moule à tarte tatin Choc

de Buyer

Aluminium avec revêtement anti-adhésif multi-couches : préparation et cuisson dans un seul récipient.

			P.U. HT
53325P	∅ 28 x H. 4,5 cm	x 1	52,00 €



## Charlotte embouti fond uni

BRANITE 100%  
**GOBEL**  
LA BIEN-ÊTRE DES CUISINIÈRES

Anti-adhésif. Sans couvercle.

			P.U. HT
38755	∅ 18 x H. 10 cm	x 6	17,00 €



## Moule à manqué rond uni

BRANITE 100%  
**GOBEL**  
LA BIEN-ÊTRE DES CUISINIÈRES

Anti-adhésif.

			P.U. HT
35329	∅ 16 x H. 4 cm	x 6	6,40 €
35330	∅ 18 x H. 4,5 cm	x 6	7,90 €
35331	∅ 22 x H. 5 cm	x 6	9,00 €
35332P	∅ 26 x H. 5 cm	x 1	11,10 €
1013426P	∅ 30 x H. 5,3 cm	x 1	15,50 €





## Caisse à génoise

Anti-adhésif.

**56122P** L. 51 x l. 36 x H. 5 cm



x 1

FRANCE 1951  
**GOBEL**  
Le spécialiste des moules à pâtisserie

**P.U. HT**  
**47,00 €**



## Caisse à génoise

Fer blanc.

**2311** L. 40 x l. 30 x H. 3,5 cm

**2312** L. 51 x l. 36 x H. 5 cm

**2313** L. 61 x l. 41 x H. 5 cm



x 1

FRANCE 1951  
**GOBEL**  
Le spécialiste des moules à pâtisserie

**P.U. HT**  
**22,25 €**  
**27,75 €**  
**32,50 €**



## Mini pâté

Anti-adhésif, à charnières, fond démontable.

**45370** L. 30 x l. 4 x H. 6 cm

**45371** L. 50 x l. 4 x H. 6 cm



x 1

FRANCE 1951  
**GOBEL**  
Le spécialiste des moules à pâtisserie

**P.U. HT**  
**30,50 €**  
**35,50 €**

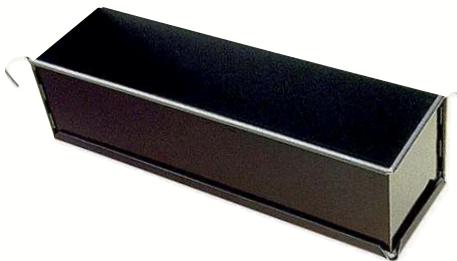

## Moule à pâté

Anti-adhésif, à charnières, fond démontable.

**1004689** L. 30 x l. 8 x H. 8 cm

**1004686** L. 35 x l. 8 x H. 8 cm

**1004687** L. 40 x l. 8 x H. 8 cm

**1004688** L. 50 x l. 8 x H. 8 cm



x 1

FRANCE 1951  
**GOBEL**  
Le spécialiste des moules à pâtisserie

**P.U. HT**  
**34,00 €**  
**35,75 €**  
**37,00 €**  
**38,50 €**



## Cake évasé

Fer blanc revêtu d'étain.

**38745** L. 18 x l. 7,5 x H. 6,5 cm

**38747** L. 24 x l. 9 x H. 7,5 cm

**38749** L. 30 x l. 10 x H. 8 cm

**38751** L. 36 x l. 10,5 x H. 8 cm



x 6

FRANCE 1951  
**GOBEL**  
Le spécialiste des moules à pâtisserie

**P.U. HT**  
**9,70 €**  
**10,40 €**  
**11,00 €**  
**11,70 €**



## Cake ouvrant

Anti-adhésif. Fixe ou ouvrant, pour un démoulage parfait et facile.

**35333** L. 24 x l. 9,5 x H. 7 cm

**35335P** L. 30 x l. 10 x H. 7,5 cm



x 2

FRANCE 1951  
**GOBEL**  
Le spécialiste des moules à pâtisserie

**P.U. HT**  
**20,50 €**  
**26,00 €**



## Cake

Fer doux revêtu d'anti-adhésif.

**38753** E L. 26 x l. 9,5 x H. 7,5 cm

**38754P** E L. 28 x l. 10 x H. 7,5 cm



x 6

FRANCE 1951  
**GOBEL**  
Le spécialiste des moules à pâtisserie

**P.U. HT**  
**12,60 €**  
**13,00 €**

nouveau !

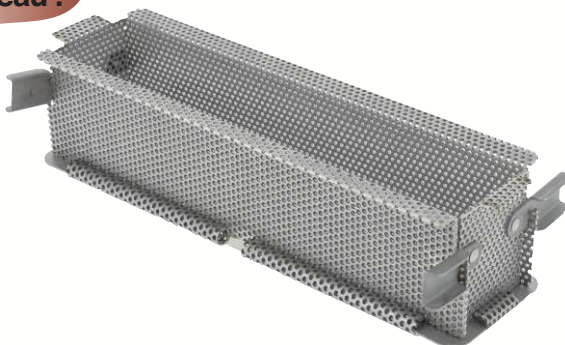

## Moule inox pliant perforé

de Buyer

Le 1er moule professionnel dépliant dont on ne perd pas les charnières ! Bords perforés pour une cuisson homogène.

**1013435** L. 35 x l. 7 x H. 7,5 cm

**1013436** L. 48 x l. 9 x H. 8,5 cm



x 1

**P.U. HT**  
**69,50 €**  
**81,00 €**



### Découpoir inox

Inox. Ø 4,5 cm à 12,5 cm.



Uni  
✓ **49269P** E Boîte de 9



x 1

**P.U.HT**  
**28,25 €**



Cannelé  
✓ **49270P** E Boîte de 9



x 1

**P.U.HT**  
**30,75 €**

### Emporte-pièces rond cannelé

Inox. H 3,5 cm.



<b>35190</b>	Ø 4 cm	x 1	<b>15,75 €</b>
<b>35192</b>	Ø 8 cm	x 1	<b>17,25 €</b>
<b>35193</b>	Ø 10 cm	x 1	<b>18,50 €</b>
<b>35194</b>	Ø 12 cm	x 1	<b>20,25 €</b>

### Découpoir polyglass

Découpoir polyglass rond : Ø 2 - 3 - 4 - 5 - 6 - 7 - 8 - 9 - 10 cm. Découpe nette et précise de la pâte. Bonne prise en main grâce à son bord épais et arrondi. Résistant jusqu'à 150°C.

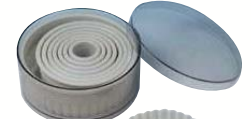
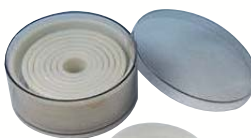

Uni  
✓ **68302** Boîte de 9



x 1

**P.U.HT**  
**19,50 €**

Cannelé  
✓ **68300** Boîte de 9



x 1

**P.U.HT**  
**19,50 €**

### Emporte-pièces bateau cannelé

Inox. H 3,5 cm.



<b>35200</b>	L. 8 x l. 4,5 cm	x 1	<b>18,75 €</b>
<b>35201</b>	L. 10 x l. 5,5 cm	x 1	<b>20,50 €</b>
<b>35202</b>	L. 12 x l. 6 cm	x 1	<b>23,25 €</b>

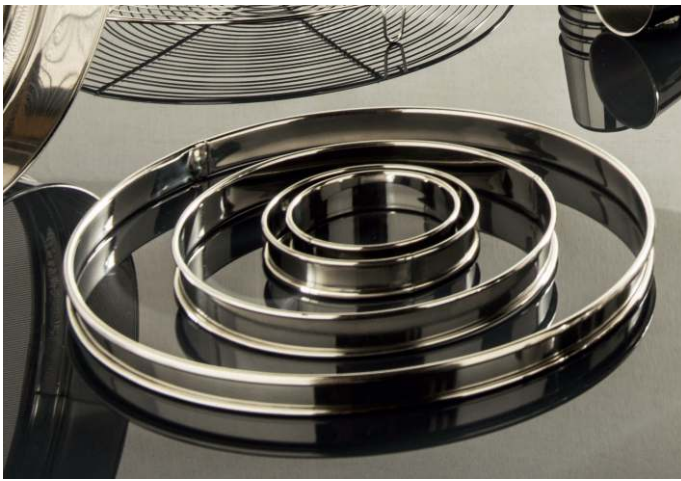

## Cercle à tarte

Inox. H. 2 cm. Bords roulés.



	Ø		P.U.HT
1001415P	8 cm	x 1	2,40 €
38723	9 cm	x 6	2,50 €
1001416P	10 cm	x 1	2,60 €
35211	12 cm	x 6	2,70 €
35212	14 cm	x 6	2,80 €
35213	16 cm	x 6	2,90 €
1001417P	18 cm	x 1	3,10 €
35215	20 cm	x 6	3,30 €
35216	22 cm	x 6	3,50 €
2301	24 cm	x 6	3,80 €
2302	26 cm	x 6	4,10 €
1001418P	28 cm	x 1	7,50 €
35217	30 cm	x 6	7,90 €
30363	32 cm	x 6	8,50 €

## Cercle à entremet

Inox. H. 3,5 cm.



	Ø		P.U.HT
67656P	10 cm	x 1	7,20 €

## Nonette

Inox. H. 4,5 cm.



	Ø		P.U.HT
69302P*	6 cm	x 12	5,30 €
69303P	6 cm	x 12	5,70 €

\* hauteur 4 cm

## Cercle à mousse

Inox. H. 4,5 cm.



	Ø		P.U.HT
1001413P*	7,5 cm	x 1	4,10 €
1001414P	8 cm	x 1	4,30 €
1001411P	12 cm	x 1	5,50 €
38720	14 cm	x 1	5,80 €
2294	16 cm	x 1	6,00 €
2295	18 cm	x 1	6,80 €
1001412P	24 cm	x 1	10,60 €
35209	26 cm	x 1	10,80 €

\* hauteur 4 cm

## Cercle à vacherin

Inox. H. 6 cm.



	Ø		P.U.HT
35220	16 cm	x 1	6,70 €
35221	18 cm	x 1	7,10 €
35222	22 cm	x 1	10,50 €
1005088P	24 cm	x 1	11,00 €
35223	26 cm	x 1	11,50 €
2300	28 cm	x 1	11,90 €

## Cadre extensible

Inox. Cadre forme ajustable.

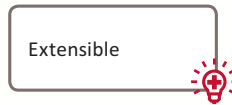

			P.U.HT
68628P	21,5 x 11,5 cm à 40 x 21 cm	x 1	27,00 €
1005091P	30 x 30 cm à 57 x 57 x H.5 cm	x 1	53,00 €

## Cadre à flan

Inox. H. 2 cm.



			P.U.HT
45354	L. 35 x l. 11	x 3	18,25 €
45355	L. 55 x l. 11	x 3	22,75 €

## Cadre à opéra

Inox.



			P.U.HT
1001406P	L. 57 x l. 37 x H. 4 cm	x 1	55,50 €
1001407P	L. 57 x l. 37 x H. 6 cm	x 1	71,50 €



## Spray démouleur\*

Il s'applique sur les moules ou les supports techniques pour éviter aux produits d'attacher. Composition exclusivement végétale, sans OGM et non ionisée.

			P.U.HT
69719P*	600 ml	x 1	6,10 €

\* Dangereux. Respecter les précautions d'emploi. Produit conforme à la législation française.



# PIZZA PARTY

## Machine à pâtes

Inox.



**66427P** L. 20,8 x l. 19 cm x 1 **P.U.HT 89,50 €**

## Balayette bois



**45179** L. 48 cm x 40 **P.U.HT 3,90 €**

## Caisse à patons 15 L

PEHD.

**Gilac**  
PROFESSIONNEL



**45019P** L. 60 x l. 40 x H. 8,5 cm x 1 **P.U.HT 14,30 €**  
**68623P** Couverture x 1 **9,70 €**

## Louchette à pizza

Inox.



**71175P** Ø 9,2 cm - 14,5 cl x 1 **P.U.HT 20,00 €**

## Boîte à épices

En ABS. 6 compartiments amovibles.



**65061P** L. 49 x l. 16 x H. 9,7 cm x 1 **P.U.HT 46,50 €**

## Plaque tôle pleine

de Buyer



**45175** Ø 28 cm x 5 **P.U.HT 7,40 €**  
**45176P** Ø 32 cm x 1 **8,80 €**  
**45177** Ø 36 cm x 5 **10,50 €**  
**45178** Ø 40 cm x 5 **13,20 €**

## Boîte à ingrédients

**zope**



5 bacs GN 1/9 **P.U.HT 393,00 €**  
**63190P** L. 57 x l. 19 x H. 18 cm x 1

## Plaque tôle perforée

de Buyer



**52707P** Ø 28 cm x 5 **P.U.HT 8,50 €**  
**52708** Ø 32 cm x 1 **9,60 €**

## Grille à pizza

Inox.

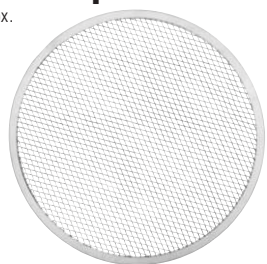

**67628P** Ø 31 cm x 12 **P.U.HT 11,40 €**  
**67629P** Ø 33 cm x 12 **12,50 €**

## Roulette à pizza



**67651P** x 1 **P.U.HT 9,80 €**

## Pelle à pizza



**A 45181** 31 x 31 x L. 128 cm x 1 **P.U.HT 55,50 €**  
**B 45182P** Ø 32 x L. 130 cm x 1 **48,00 €**



## Film PVC non prédécoupé



Paquet de 1			<b>P.U.HT</b>
<b>1001457P</b>	L. 300 m x l. 60 cm - Ep. 8 µ	x 4	<b>14,40 €</b>
<b>48634P</b>	L. 500 m x l. 45 cm - Ep. 7,5 µ	x 4	<b>17,00 €</b>
Paquet de 4			<b>P.U.HT</b>
<b>59152P</b>	E L. 300 m x l. 30 cm - Ep. 9 µ	x 1	<b>24,00 €</b>
<b>59153P</b>	E L. 300 m x l. 45 cm - Ep. 9 µ	x 1	<b>29,25 €</b>



## Film PVC prédécoupé



Propre dispositif de coupe. Lame sécurisée et hygiénique grâce au boîtier hermétique. Epaisseur 8µ.

<b>48635P</b>	L. 500 m x l. 36 cm		<b>P.U.HT</b>
		x 4	<b>18,50 €</b>



## Film PVC en boîte Press & Cut



Propre dispositif de coupe. Lame sécurisée et hygiénique grâce au boîtier hermétique. PVC. Epaisseur 8µ.

<b>65724P</b>	L. 300 m x l. 30 cm		<b>P.U.HT</b>
		x 1	<b>13,00 €</b>
<b>65723P</b>	L. 300 m x l. 45 cm		<b>P.U.HT</b>
		x 1	<b>17,00 €</b>



## Film PVC en boîte distributrice



Cutter pratique. Epaisseur 9µ. Lame sécurisée et hygiénique grâce au boîtier hermétique.

<b>54083P</b>	L. 300 m x l. 30 cm		<b>P.U.HT</b>
		x 1	<b>8,80 €</b>
<b>54084P</b>	L. 300 m x l. 45 cm		<b>P.U.HT</b>
		x 1	<b>12,30 €</b>



## Film PVC



Boîte distributrice avec découpoir.

	<b>48647P</b>	E L. 300 m x l. 30 cm		<b>P.U.HT</b>
			x 1	<b>5,80 €</b>
	<b>48648P</b>	E L. 300 m x l. 45 cm		<b>P.U.HT</b>
			x 1	<b>7,90 €</b>



## Aluminium

Paquet de 3			<b>P.U.HT</b>
<b>49780P</b>	L. 200 m x l. 30 cm - Ep. 11 µ	x 1	<b>51,50 €</b>
Paquet de 1			<b>P.U.HT</b>
<b>49762P</b>	L. 200 m x l. 33 cm - Ep. 19 µ	x 6	<b>40,75 €</b>
<b>1008363P</b>	E L. 200 m x l. 33 cm - Ep. 10,5 µ	x 3	<b>16,75 €</b>
<b>1005811P</b>	E L. 200 m x l. 45 cm - Ep. 12 µ	x 3	<b>31,25 €</b>

### 1<sup>er</sup> PRIX



## Aluminium en boîte distributrice

Boîte distributrice avec découpoir. Agréé contact alimentaire.

	<b>49760P</b>	E L. 200 m x l. 33 cm - Ep. 10,5 µ		<b>P.U.HT</b>
			x 1	<b>18,25 €</b>
	<b>49759P</b>	E L. 200 m x l. 45 cm - Ep. 10,5 µ		<b>P.U.HT</b>
			x 1	<b>29,50 €</b>





## Papier siliconé multicuisson



Pour cuire, frire, congeler (jusqu'à -40°C), décorer, stocker, superposer...

			P.U.HT
Carton distributeur de 500 feuilles			
49410P	E Une face - GN 1/1 - L. 53 x l. 32,5 cm	x 1	30,50 €
50747P	Une face - L. 60 x l. 40 cm	x 1	32,75 €
53141P	E Double face - L. 60 x l. 40 cm	x 1	40,00 €



## Film de cuisson en boîte distributrice



Film pour cuisson traditionnelle et au grill. Les aliments doivent être disposés dans le film et ce dernier fermé par un lien (fourni). Conserve toutes les qualités nutritives et gustatives des aliments. Film pouvant être utilisé jusqu'à 220°C. Passage en surgélation à -70°C. Epaisseur 12 µ.

			P.U.HT
68515P	E L. 50 m x l. 50 cm	x 1	29,75 €



## Sac congélation

En polyéthylène transparent. Epaisseur 25 µ.

			P.U.HT
49051P	E L. 36 x l. 24 cm - Boîte de 300	x 1	20,75 €
49052P	L. 45 x l. 30 cm - Boîte de 200	x 1	21,25 €
49053P	L. 50 x l. 35 cm - Boîte de 150	x 1	18,25 €

nouveau !



## Distributeur universel



En polycarbonate. Pour laize de 29 à 45 cm. Dispose de deux systèmes de découpe : Zip Cut et lame de scie de sécurité. Se pose sur le plan de travail ou se fixe au mur.

			P.U.HT
1013679	L. 58,8 x l. 19,3 x H. 16,5 cm	x 1	50,50 €



## Distributeur universel Laize 45

Tout inox. Aisément démontable pour un nettoyage complet et une hygiène totale. Fixation murale fournie avec règle coupe-film 45 cm. Poids net : 2,7 kg.

			P.U.HT
61358	L. 56 x l. 14 x H. 13,5 cm	x 1	108,00 €



## Distributeur universel Laize 54



Réglage intérieur en fonction de la laize. Protection contre la poussière ou les projections par vitre frontale. A fixer au mur (visserie non fournie).

			P.U.HT
38499P	E L. 54 x l. 11 x H. 11 cm	x 1	102,00 €



# CAMBRO

TRUSTED FOR GENERATIONS™



**nouveau!**

Conteneur isotherme 60 x 40 cm avec glissières ajustables.

## **Cambro®**, leader des équipements pour la restauration.

De la réception au stockage et du stockage à la livraison, Cambro offre des solutions telles que : les plateaux, les produits de stockage, les rayonnages, les transports de repas en liaison chaude ou froide, le lavage et stockage de la vaisselle, le service de la table et les articles de présentation. Les produits Cambro permettent aux professionnels de la restauration d'améliorer la sécurité, l'efficacité et la rentabilité des opérations.



# TRANSPORT DE REPAS

PLATEAUX ISOTHERMES .....458

CONTENEURS .....459

FOURS / ARMOIRES DE MAINTIEN  
EN TEMPÉRATURE .....465



Vaisselle spéciale  
régithermie  
voir page 97



A



B



C

Sans bisphénol A

## Plateau isotherme Tablotherm **CAMBRO**

TRUSTED FOR GENERATIONS™



TABLOTHERM est une solution idéale de livraison de repas individualisés pour un service en chambre ou à domicile. Plateau fabriqué d'un seul bloc, sans raccord, en polypropylène double paroi avec mousse isolante. Maintien les aliments au chaud pendant 1 H environ.

### Plateau isotherme - Gris bleu

Comprend : une assiette à deux compartiments, un couvercle réutilisable, une plaque chaude, trois bols (deux de 40 cl et un de 50 cl, avec leurs couvercles réutilisables).

**1011184** E L. 37 x l. 53 x H. 10,5 cm x 1 **P.U.HT 195,00 €**

### Plaque chaude

**65769** E Polymère Ø 16,5 cm x 1 **P.U.HT 8,50 €**

### Assiette 2 compartiments

**65469** E Ø 25,6 cm - 75 cl x 1 **P.U.HT 12,40 €**

### Couvercle en polypropylène pour assiette

**65471** E Ø 26 x H. 5 cm - Gris x 1 **P.U.HT 15,00 €**

### Bol porcelaine sans couvercle

**65470** E Ø 12,2 cm - 40 cl - Blanc x 1 **P.U.HT 3,60 €**

**1006342** E Ø 14,2 cm - 50 cl - Blanc x 1 **P.U.HT 9,80 €**

### Couvercle en polypropylène pour bol 40 cl

**65472** E Ø 12,2 x H. 1,5 cm - Gris x 1 **P.U.HT 7,50 €**



REVOL



## Bol à potage

En porcelaine blanche.

**44040** 37 cl x 6 **P.U.HT 8,60 €**

## Malinette



Conteneur isotherme pour le repas individuel multi-températures. À utiliser avec les casseroles en pyrex avec couvercles étanches et les plaques froides et chaudes pour prolonger le maintien thermique. 4 compartiments dont 3 de Ø 13 cm pour les bols.

### Malinette complète

Comprend : 4 bols en pyrex avec couvercle étanche, 2 plaques chaudes et 2 plaques (eutectiques) froides.

**1006571** E L. 34 x l. 34 x H. 17 cm - Poids 4,4 kg x 1 **P.U.HT 323,00 €**

### Malinette vide rouge

**1006572** E L. 34 x l. 34 x H. 17 cm - Poids 2,2 kg x 1 **P.U.HT 165,00 €**

### Bol avec couvercle

**50621** E 55 cl - Ø 12 x H. 6 cm x 1 **P.U.HT 16,00 €**

### Plaque froide

**1006574** E Ø 12 x H. 1,8 cm - Bleu x 1 **P.U.HT 26,00 €**

### Plaque chaude

**1006575** E Ø 12 x H. 1,8 cm - Rouge x 1 **P.U.HT 28,25 €**

## Couvre-assiette



Transparent et sablé : bonne visibilité du contenu, bonne résistance aux rayures et pas de trace de calcaire. Dimensions idéales en milieu hospitalier : Ø 23,8 cm. H. hors tout 4,6 cm. H. utile 3,7 cm.

**A 49317P** E Copolyester blanc transparent. Résistance en montée en température jusqu'à 90°C. x 1 **P.U.HT 6,20 €**

**B 49318P** E Polyamide vert transparent. Résistance en montée en température jusqu'à 150°C. x 1 **P.U.HT 10,10 €**

Bonne préhension.

Polyvalent : s'adapte pour des assiettes du Ø 23 cm au Ø 25 cm. Diamètre : Ø 25,4 cm. H. hors tout 6,5 cm.

**C 40151P** Copolyester transparent - Résistance 90°C. x 5 **P.U.HT 4,70 €**

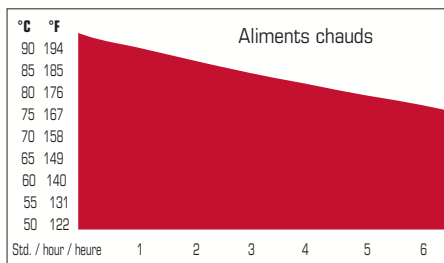
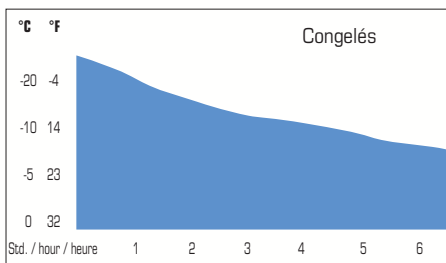

## Thermobox



Polypropylène très robuste, léger et durable. Idéal pour le transport, le stockage et comme caisson isotherme. Résistant aux chocs et à l'acidité. Supporte des températures de - 40 à + 120°C. Transport confortable. Nettoyage à l'eau chaude. Coloris noir.



### Box GN 1/1

Ouverture sur le dessus.

#### Box 38 L

**55191** E Dim. ext. 59,5 x 39 x H. 28 cm  
Dim. int. 53,5 x 33 x H. 22 cm  
Poids 1,15 kg

x 1 **P.U.HT**  
**57,50 €**

Dont Éco-participation 0,08€

#### Box 45 L

**56637** E Dim. ext. 59,5 x 39 x H. 32 cm  
Dim. int. 53,5 x 33 x H. 26 cm  
Poids 1,2 kg

x 1 **P.U.HT**  
**64,00 €**

Dont Éco-participation 0,08€



### Box combi

Ouverture frontale.

#### Box format GN 1/1 - 83 L

Parois latérales interchangeables. 12 séparations pour plateaux ou bacs GN 1/1. Possibilité de 2 bacs GN 1/1, prof. max 20 cm.

**55193** Dim. ext. 63 x 50 x 58 cm  
Dim. int. 53,5 x 33 x 47 cm  
Poids 5,5 kg

x 1 **P.U.HT**  
**286,00 €**

Dont Éco-participation 0,30€

#### Box format pâtissier - 125 L

Parois latérales interchangeables, réversibles 3 ou 5 niveaux : il suffit de retirer les parois latérales, les retourner et les remettre en place.

**55194** Dim. ext. 70 x 58 x 62 cm  
Dim. int. 62 x 40,5 x 51 cm  
Poids 6,5 kg

x 1 **P.U.HT**  
**312,00 €**

Dont Éco-participation 0,42€



### Box pliable

Idéal pour transporter la marchandise en vrac jusqu'à 30 kg. Pliable pour un gain de place. Fermé H.12 cm.

**59312** Dim. ext. 68,5 x 48,5 x 34 cm  
Dim. int. 62,5 x 42,5 x 27 cm  
Poids 1,6 kg.

x 1 **P.U.HT**  
**92,00 €**

Dont Éco-participation 0,16€





## Conteneur à chargement par le haut

En polypropylène expansé.

**CAMBRO**  
TRUSTED FOR GENERATIONS™



Format GN 1/2			P.U.HT
<b>1011741</b>	16,9 L - Dim ext. L. 39 x l. 33 x H. 25,7 cm - Dim int. L. 33 x l. 27 x H. 19,3 cm - Poids 0,62 kg	x 1	<b>49,50 €</b>
<b>1011742</b>	22,3 L - Dim ext. L. 39 x l. 33 x H. 31,6 cm - Dim int. L. 33 x l. 27 x H. 25,3 cm	x 1	<b>53,50 €</b>
Format GN 1/1			P.U.HT
<b>1008170</b>	E 35,5 L - Dim ext. L. 60 x l. 40 x H. 25,7 cm - Dim int. L. 53,8 x l. 33,8 x H. 19,3 cm - Poids 1,05 kg	1	<b>41,00 €</b>
<b>1008168</b>	E 46 L - Dim ext. L. 60 x l. 40 x H. 31,6 cm - Dim int. L. 53,8 x l. 33,8 x H. 25,3 cm - Poids 1,2 kg	1	<b>43,25 €</b>
Format Pâtissier 60x40 cm			P.U.HT
<b>1011744</b>	53 L - Dim ext. L. 48,7 x l. 68,7 x H. 26,8 cm - Dim int. L. 42,5 x l. 62,5 x H. 19,6 cm - Poids 0,7 kg	x 1	<b>47,00 €</b>
<b>1011743</b>	80 L - Dim ext. L. 48,7 x l. 68,7 x H. 36,8 cm - Dim int. L. 42,5 x l. 62,5 x H. 29,6 cm - Poids 1,24 kg	x 1	<b>54,00 €</b>

## Conteneur à chargement frontal

En polypropylène expansé.

**CAMBRO**  
TRUSTED FOR GENERATIONS™



Format GN 1/1			P.U.HT
<b>1008169</b>	E 60 L - Dim ext. L. 64,5 x l. 44 x H. 47,5 cm - Dim int. L. 53,5 x l. 33 x H. 37 cm - Poids 3,1 kg	1	<b>199,00 €</b>
<b>1008167</b>	E 86 L - Dim ext. L. 64,5 x l. 44 x H. 63 cm - Dim int. L. 53,5 x l. 33 x H. 52,5 cm - Poids 3,9 kg	1	<b>225,00 €</b>
Format Pâtissier 60 x 40 cm			P.U.HT
<b>1011745</b>	126 L - Dim ext. L. 77 x l. 54 x H. 68,7 cm - Dim int. L. 61,5 x l. 41 x H. 58,5 cm	x 1	<b>481,00 €</b>

nouveau !

Modulable : ajoutez le kit glissières et transportez alors caisses 60x40, bacs et plaques dans un même conteneur



## Conteneur 60x40

Les conteneurs multifonctions ultra-légers frontaux sans glissières sont conçus pour transporter des caisses de 60 x 40 cm remplis d'aliments emballés ou reconditionnés.

**CAMBRO**  
TRUSTED FOR GENERATIONS™

<b>1013443</b>	155 L - Dim ext. L. 77 x l. 54 x H. 68,7 cm - Dim int. L. 61,5 x l. 41 x H. 58,5 cm - Poids 6,1 kg	x 1	<b>249,00 €</b>
----------------	--	-----	-----------------

nouveau !



## Kit glissières

Cadre métallique et 2 sets de glissières ajustables (2 niveaux).

**CAMBRO**  
TRUSTED FOR GENERATIONS™

<b>1013444</b>	L. 60 x l. 1 x H. 58 cm - Poids : 2,07 kg	1	<b>114,00 €</b>
----------------	---	---	-----------------

## Plaque

**CAMBRO**  
TRUSTED FOR GENERATIONS™

<b>1008171</b>	E L. 53 x l. 32,5 x H. 3 cm - 3,25 kg	1	<b>90,50 €</b>
<b>1008172</b>	E L. 53 x l. 32,5 x H. 3 cm - 3,9 kg	1	<b>62,00 €</b>
<b>1013382</b>	L. 32,5 x l. 26,5 x H. 3 cm - 3,9 kg	1	<b>40,75 €</b>

## Chariot Camdolly

4 roues pivotantes dont 2 à freins.

**CAMBRO**  
TRUSTED FOR GENERATIONS™

<b>1011746</b>	E L. 62,5 x l. 42 x H. 17 cm - 4,5 kg Dont Éco-participation 0,76€	x 1	<b>81,00 €</b>
----------------	---	-----	----------------

<b>1011747</b>	L. 72 x l. 52 x H. 15,7 cm - 5,45 kg Dont Éco-participation 0,80€	x 1	<b>82,50 €</b>
----------------	--	-----	----------------

## Plateau Tablotherm

Plateau isotherme Tablotherm ultra léger fabriqué en polypropylène expansé pour la distribution de repas. Vendu avec 1 assiette compartimentée de 23 cm, 2 bols de 14 cm en porcelaine et couvercles réutilisables.

**CAMBRO**  
TRUSTED FOR GENERATIONS™



<b>1011750</b>	E L. 53 x l. 37 x H. 11,8 cm - gris - 2,32 kg	x 1	<b>96,00 €</b>
----------------	---	-----	----------------



## Conteneur isotherme à liquide

**CAMBRO**  
TRUSTED FOR GENERATIONS™

En polyéthylène. Maintien en température pour 4 heures. Le robinet en retrait permet de remplir des bols et assure une distribution uniforme et élimine le goutte à goutte. Deux positions : une pour l'écoulement en continu et l'autre pour le service tasse par tasse. Chaque unité est fournie avec un jeu d'autocollants portant le nom des boissons. Isolation par mousse de polyuréthane. Poignées moulées dans la masse. Superposable.

### PERFORMANCES ISOTHERMES :

Une baisse de température en moyenne, de seulement 1,8 °C par heure.

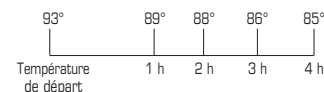

Une élévation de la température en moyenne, de seulement 0,34 °C par heure.



Avec robinet 10,4 L



Sans robinet 12,7 L



Avec robinet 18 L



	<b>UC 250</b>	<b>LCD 350</b>	<b>LCD 500</b>
Caractéristique	AVEC ROBINET - Granité gris	SANS ROBINET - Bleu ardoise	AVEC ROBINET - Bleu ardoise
Contenance	10,4 L	12,7 L	18 L
Capacité	49 tasses de 21 cl	61 tasses de 21 cl	85 tasses de 21 cl
Dimensions (L x l x H)	42,5 x 30 x 50 cm	42 x 23 x 47 cm	42 x 23 x 62 cm
Poids	6,85 kg	6 kg	7,3 kg
Référence	<b>43436</b>	<b>43435</b> €	<b>63666</b> €
P.U.H.T	<b>305,00 €</b>	<b>268,00 €</b>	<b>305,00 €</b>

## Conteneur isotherme

**ANIMO**

En inox. Double paroi. Isolation en mousse polyuréthane. Hygiénique grâce à sa soudure bord à bord. Couvre-fer isolant. Empilable. Passe au lave-vaisselle.



Avec robinet  
6 L - 8 L - 10 L



Sans robinet  
6 L - 8 L - 10 L



	<b>Avec robinet</b>			<b>Sans robinet</b>		
Contenance	6 L	8 L	10 L	6 L	8 L	10 L
Dimensions	Ø 23,7 x H 34,6 cm	Ø 25,2 x H 43,6 cm	Ø 25,2 x H 48,9 cm	Ø 23,8 x H 28 cm	Ø 25,2 x H 31 cm	Ø 25,2 x H 36,2 cm
Référence	<b>61360</b> €	<b>61359</b> €	<b>39168</b> €	<b>61361</b> €	<b>49225</b> €	<b>49226</b> €
P.U.H.T	<b>400,00 €</b>	<b>438,00 €</b>	<b>476,00 €</b>	<b>347,00 €</b>	<b>352,00 €</b>	<b>404,00 €</b>





## Conteneur UPC 300



Idéal pour le transport de repas chauds, froids ou même surgelés en conformité avec la démarche HACCP en vigueur. Empilable et d'une extrême robustesse : fabrication monobloc sans soudure en polyéthylène haute densité.

UPC 300	
Caractéristique	34 L - Bleu ardoise
Dim. ext. (L x l. x H.)	43,2 x 65,4 x 56,8 cm
Dim. int. (L x l. x H.)	34 x 55,5 x 35,6 cm
Poids	11,05 kg
Capacité bac GN 1/1 Prof. 6,5 cm	4
Capacité bac GN 1/1 Prof. 10 cm	3
Capacité bac GN 1/1 Prof. 15 cm	2
Capacité bac GN 1/1 Prof. 20 cm	1
Référence	<b>1011748 E</b>
P.U.H.T	<b>344,00 €</b>

nouveau !



## Socle rouleur

Socle rouleur bleu ardoise pour conteneur neutre frontal UPC300. Poids 7,15 kg.

<b>1013446</b>	L. 65,5 x l. 49 x H. 26,5 cm	x 1	<b>P.U.HT</b> <b>316,00 €</b>
----------------	------------------------------	-----	----------------------------------



A

## Conteneur UPC



Conteneurs de construction robuste en polyéthylène monobloc sans soudure.

	A - UPC 400	B - UPC 800
Caractéristique	57 L - Bleu ardoise	2 x 58,5 L avec roulettes, 12 glissières - Bleu ardoise
Dim. ext. (L x l. x H.)	63,3 x 46 x 62 cm	69 x 51 x 137 cm
Dim. int. (L x l. x H.)	53,3 x 33,5 x 49 cm	54 x 33,5 x 49 cm
Poids	15,07 kg	39,01 kg
Capacité bac GN 1/1 Prof. 6,5 cm	6	12
Capacité bac GN 1/1 Prof. 10 cm	4	8
Capacité bac GN 1/1 Prof. 15 cm	3	6
Capacité bac GN 1/1 Prof. 20 cm	2	4
Référence	<b>1002775 E</b>	<b>43440 E</b>
P.U.H.T	<b>444,00 €</b>	<b>1 284,00 €</b>

Dont Éco-participation 3,12 €



B

## Plaque pour conteneur GN 1/1



Plaque chaude GN 1/1	<b>1008171</b>	E L. 53 x l. 32,5 x H. 3 cm - 3,25 kg	x 1	<b>P.U.HT</b> <b>90,50 €</b>
Plaque froide GN 1/1	<b>1008172</b>	E L. 53 x l. 32,5 x H. 3 cm - 3,9 kg	x 1	<b>P.U.HT</b> <b>62,00 €</b>
Plaque froide GN 1/2	<b>1013382</b>	L. 32,5 x l. 26,5 x H. 3 cm - 3,9 kg	1	<b>P.U.HT</b> <b>40,75 €</b>

## Séparation isotherme Thermobarrier

S'adapte sur les conteneurs UPCS 400, UPC 400 et UPC 800.



<b>43438</b>	E L. 54 x l. 33 x H. 3,8 cm - Poids 1,8 kg	x 1	<b>P.U.HT</b> <b>102,00 €</b>
--------------	--	-----	----------------------------------



## Conteneur isotherme UPCS 180

Ce conteneur isotherme à chargement par le haut est idéal pour conserver, transporter et servir les aliments chauds ou froids en bac GN 1/1.

Construction en polypropylène durable avec joint intégré et gros systèmes de fermeture en nylon.

**CAMBRO**  
TRUSTED FOR GENERATIONS™

<b>UPCS 180</b>	
Caractéristique	23 L - Gris moucheté
Dim. ext. (L x l. x H.)	64 x 43,5 x 30,5 cm
Dim. int. (L x l. x H.)	53 x 32,5 x 20 cm
Capacité du compartiment	1 bac GN 1/1 Prof. 20 cm ou 2 bacs GN 1/2 ou 3 bacs GN 1/3
Poids (kg)	7,91 kg
Référence	<b>58465 E</b>
<b>P.U.H.T</b>	<b>317,00 €</b>
	Dont Éco-participation 0,63 €



## Conteneur isotherme UPCS 400

Ce conteneur isotherme à chargement par l'avant est idéal pour conserver, transporter et servir les aliments chauds ou froids en bacs GN 1/1.

Coque en polyéthylène durable avec épaisse couche isolante en mousse polyuréthane pour un meilleur maintien de la température. La porte s'enlève pour faciliter le nettoyage.

**CAMBRO**  
TRUSTED FOR GENERATIONS™

<b>A - UPCS400</b>	
Caractéristique	58,5 L - 12 glissières sans roulettes - Gris moucheté
Dim. ext. (L x l. x H.)	63,5 x 46 x 63 cm
Dim. int. (L x l. x H.)	53,5 x 33,5 x 48,6 cm
Poids (kg)	18 kg
Accessoire	1008171, 43438, 1008172
Capacité bac GN 1/1 Prof. 6,5 cm	6
Capacité bac GN 1/1 Prof. 10 cm	4
Capacité bac GN 1/1 Prof. 15 cm	3
Capacité bac GN 1/1 Prof. 20 cm	2
Référence	<b>61459P E</b>
<b>P.U.H.T</b>	<b>444,00 €</b>
	Dont Éco-participation 1,20 €

### B - Chariot Camdolly pour conteneur UPCS 400

4 roues Ø 12,7 cm (2 fixes, 2 pivotantes) dont 1 à frein. Charge maxi 136 kg.

<b>43439</b>	E Bleu ardoise - L. 71 x l. 53 x 23 cm.	<b>P.U.HT</b>
	x 1	<b>338,00 €</b>
		Dont Éco-participation 0,71 €

### C - Kit de 4 roues pour UPCS 400

<b>1013445</b>	Ø 12,7 cm	<b>P.U.HT</b>
	x 1	<b>191,00 €</b>



## Conteneur chauffant UPCH

Les unités de transport prolongent le temps de conservation des plats chauds et assurent la salubrité des aliments.

**CAMBRO**  
TRUSTED FOR GENERATIONS™

<b>A - UPCH 4002</b>	
Caractéristique	58,5 L - Bleu ardoise
Dim. ext. (L x l. x H.)	67 x 46 x 63 cm
Dim. int. (L x l. x H.)	53,3 x 33,5 x 48,6 cm
Alimentation	220 V
Puissance	265 W
Poids (kg)	20,45 kg
Capacité bac GN 1/1 Prof. 6,5 cm	6
Capacité bac GN 1/1 Prof. 10 cm	4
Capacité bac GN 1/1 Prof. 15 cm	3
Capacité bac GN 1/1 Prof. 20 cm	2
Référence	<b>63665 E</b>
<b>P.U.H.T</b>	<b>1 235,00 €</b>

<b>B - UPCH 8002</b>	
Caractéristique	2 x 58,5 L - Bleu ardoise
Dim. ext. (L x l. x H.)	69 x 52 x 137,2 cm
Dim. int. (L x l. x H.)	54,5 x 33 x 48,5 cm x 2
Alimentation	220 V
Puissance	265 W
Poids (kg)	43,36 kg
Capacité bac GN 1/1 Prof. 6,5 cm	12
Capacité bac GN 1/1 Prof. 10 cm	8
Capacité bac GN 1/1 Prof. 15 cm	6
Capacité bac GN 1/1 Prof. 20 cm	4
Référence	<b>66240 E</b>
<b>P.U.H.T</b>	<b>2 916,00 €</b>

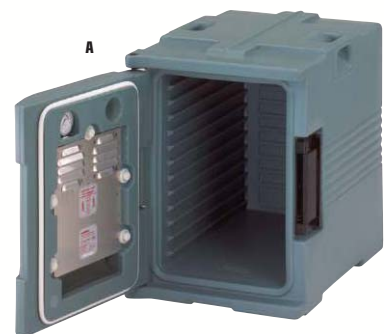



6 glissières



## Conteneur Thermax

En polyéthylène contact alimentaire avec isolation en polyuréthane expansé. Pour le transport à température contrôlée des repas en multi-portion en liaison chaude, froide et surgelée. Conteneur isotherme à ouverture frontale doté de glissières internes. Coloris gris.

MELFORM  
GARANTIE 2 ans

**Conteneur AF6- GN 1/2 et GN 1/3 - 30,5 L**  
Capacité 4 bacs GN 1/2 H. 6,5 cm.  
Poids 6,4 kg.

**1006570** Dim ext. (L x l x H) : 41 x 36 x 44 cm  
E Dim int. (L x l x H) : 33 x 27,5 x 34 cm



P.U.HT

x 1

**325,00 €**

7 glissières



**Conteneur AF 7 GN 1/1 - 63 L**  
Capacité 4 bacs GN 1/1 H. 6,5 cm.  
Poids 11 kg.

**50633** Dim ext. (L x l x H) : 44 x 64 x 48 cm  
E Dim int. (L x l x H) : 33,5 x 54 x 36 cm



P.U.HT

x 1

**334,00 €**

8 glissières



**Conteneur AF 8 GN 1/1 - 68 L**  
Capacité 4 bacs GN 1/1 H. 6,5 cm.  
Poids 11 kg.

**50636** Dim ext. (L x l x H) : 44 x 64 x 48 cm  
E Dim int. (L x l x H) : 33,5 x 54 x 38 cm



P.U.HT

x 1

**343,00 €**

L'ouverture frontale est particulièrement adaptée pour introduire de manière aisée les bacs GN1/1, GN1/2 et GN1/3. Maniable grâce aux poignées ergonomiques.



Plonger dans l'eau à 80°C pendant 50 minutes.



Mettre à congeler à -10°C minimum



Mettre à congeler à -30°C minimum.



### Plaques GN 1/1

Pour le prolongement des temps de maintien de la température interne (en liaison chaude, froide ou surgelée). L. 53 x l. 32,5 x H. 3 cm

**Plaque chaude**  
**1006573** E 4 kg



P.U.HT

x 1

**77,50 €**

**Plaque froide**  
**43017** E 4 kg



P.U.HT

x 1

**54,50 €**

**Plaque surgelée**  
**43018** E 4 kg



P.U.HT

x 1

**61,50 €**

## Armoires de maintien en température

Construction en inox alimentaire. Isolation des parois et de la porte en laine de roche. Panneau de commande intégré, à touches sensibles. Intérieur entièrement rayonné avec fond et glissières emboutis. Espace entre glissières : 71 mm. Porte pleine, inox, à ouverture 270° avec joint compressible. 2 poignées latérales de manoeuvre et une barre de guidage à l'arrière. 4 roues pivotantes dont 2 à frein.

### A hygrométrie contrôlée

	GN 2/1	GN 1/1
Capacité	20 niveaux	20 niveaux
Alimentation	230 V	230 V
Puissance absorbée	2015 W	1215 W
Dimensions	L. 73,3 x l. 94,1 x H. 191,5 cm	L. 52,8 x l. 82,1 x H. 184,4 cm
Poids	135 kg	98 kg
Référence	<b>1003418</b> €	<b>1003417</b> €
P.U.H.T	<b>4 323,00 €</b>	<b>3 982,00 €</b>

### Sans humidification

1<sup>er</sup> PRIX

	GN 2/1	GN 1/1
Capacité	20 niveaux	10 niveaux
Alimentation	230 V	230 V
Puissance absorbée	2015 W	825 W
Dimensions	L. 73,3 x l. 94,1 x H. 188 cm	L. 52,8 x l. 82,1 x H. 113,4 cm
Poids	133 kg	66 kg
Référence	<b>1003416</b> €	<b>1003415</b> €
P.U.H.T	<b>4 193,00 €</b>	<b>3 205,00 €</b>

Passage de 20 à 85°C en 25 minutes, homogénéité de la température. Nettoyage possible au jet basse-pression (IP25).



20 niveaux

1003418



10 niveaux

1003415

## Chariot bain marie

En inox. Avec surface microlissée. Réglage de température des cuves au degré près de +30°C à +95°C. 4 roues pivotantes Ø 12,5 cm dont 2 avec frein. Hauteur de travail : 90 cm. Alimentation 220 V - 1400 W. Poids 35,5 kg.

Capacité  
 2 bacs GN 1/1  
 H. 20 cm

Chariot bain marie 2 cuves  
**66308** E L. 93,3 x l. 71,4 x H. 93,6 cm x 1 **P.U.HT 1 349,00 €**





## Des solutions d'hygiène à l'image de votre établissement

La ligne Tork Elevation a été conçue dans un esprit de modernité qui s'adapte à tous les environnements sanitaires.



# HYGIÈNE & ENTRETIEN

**PRODUITS D'ENTRETIEN .....468**

**MATÉRIEL DE NETTOYAGE .....480**

**DISTRIBUTEURS ET RECHARGES .....486**

**EQUIPEMENTS .....492**

**COLLECTE DES DÉCHETS .....493**

**EQUIPEMENT DE LA PERSONNE .....498**



# Kleaning Essentials



Cuisine

Sols & Multi-usages

Surfaces

Sanitaires

Anti-odeurs



## LE CONCEPT

Une gamme de produits d'hygiène développée pour un respect total de l'Homme et de l'environnement.

### EFFICACITÉ

Biosurfactants jusqu'à 500 fois plus efficaces que ceux d'origine pétrochimique ou végétale

### SÉCURITÉ

Des produits sans risque, ni pour l'homme, ni pour l'environnement

### PROTECTION

Des produits **100 %** Éco-responsables

-  Sans étiquetage de risque
-  Ultra efficace
-  100 % naturel et biodégradable



# Une gamme complète et exclusive

Cuisine



Sols &  
multi-usages



Surfaces



Sanitaires



Anti-odeurs



Un packaging adapté  
et 100 % recyclable



### Liquide de lavage Eau dure\*



Pour le lavage automatique de la vaisselle. Dégraisse et élimine les salissures les plus tenaces : huiles, graisses, souillures organiques, tanins, café, vins, amidons, taches pigmentaires.

Non disponible en Suisse

Bidon de 5 L x 2 **P.U.HT**  
**69019\*** E **18,25 €**

\*Dangereux. Respecter les précautions d'emploi. Produit conforme à la législation française.

### Poudre de lavage Eau douce\*



Pour le lavage de toute la vaisselle : porcelaine, verres, inox, matières plastiques.

Non disponible en Suisse

Seau de 10 kg x 2 **P.U.HT**  
**69023\*** E **43,50 €**

\*Dangereux. Respecter les précautions d'emploi. Produit conforme à la législation française.

Non disponible en Suisse

Bidon de 20 L x 2 **P.U.HT**  
**69021\*** E **66,50 €**

\*Dangereux. Respecter les précautions d'emploi. Produit conforme à la législation française.

### Tablette Sun Classic\*



Doses de lavage concentrées hautes performance, spécialement formulées pour obtenir des résultats irréprochables sur les salissures tenaces quelle que soit la dureté de l'eau. Pour tous lave-vaisselle.

Non disponible en Suisse

Boîte de 2 kg x 1 **P.U.HT**  
**1008316P\*** 200 tablettes **24,25 €**

\*Dangereux. Respecter les précautions d'emploi. Produit conforme à la législation française.

### Pastilles de lavage Eau dure\*



Étudiée pour lave-verres et lave-vaisselle. S'adapte à tous types de lave-vaisselle industriels. S'utilise en eau dure et évite l'installation d'un doseur de produit de lavage.

Non disponible en Suisse

Seau 5 kg x 2 **P.U.HT**  
**69024\*** E 167 pastilles **43,25 €**

\*Dangereux. Respecter les précautions d'emploi. Produit conforme à la législation française.

### Liquide de lave-verres\*



Pour le lavage automatique de la verrerie. Efficace sur tous types de tanins (café, thé, vins, rouges à lévres...).

Non disponible en Suisse

Bidon de 1 L x 6 **P.U.HT**  
**69018\*** E **7,60 €**

\*Dangereux. Respecter les précautions d'emploi. Produit conforme à la législation française.

### Liquide de lavage Eau douce\*



Liquide de lavage vaisselle eau douce chlorée pour le lavage automatique de la vaisselle. Efficace contre le grisaillement.

Non disponible en Suisse

Bidon de 25 kg x 2 **P.U.HT**  
**69020\*** E **55,00 €**

\*Dangereux. Respecter les précautions d'emploi. Produit conforme à la législation française.

## 1<sup>er</sup> PRIX

### Liquide de lavage machine\*

Combinaison d'agents alcalins qui dissout les souillures ainsi que les huiles et les graisses. Ses différents composants assurent un lavage parfait en dispersant les salissures. Il est recommandé de prendre des précautions pour le lavage des alliages légers (aluminium et dérivés).

Non disponible en Suisse

Bidon de 5 L x 3 **P.U.HT**  
**63461P\*** E **12,00 €**

\*Dangereux. Respecter les précautions d'emploi. Produit conforme à la législation française.





## RINÇAGE MACHINE



### Liquide de rinçage Eau douce\*

exeol

Liquide de rinçage vaisselle eau douce pour le rinçage automatique de la vaisselle. Casse le film d'eau formé sur la vaisselle lors de la phase de lavage. Brillance sans trace.

Non disponible en Suisse

Bidon de 5 L  **P.U.HT**  
 69027\* E x 2 **16,25 €**

\*Dangereux. Respecter les précautions d'emploi. Produit conforme à la législation française.

1<sup>er</sup> PRIX



### Liquide de rinçage machine\*

Pour tous types de machines. Efficacité en toutes eaux. Sans pictogramme de danger.

Bidon de 5 L  **P.U.HT**  
 63459P\* E x 3 **12,00 €**

\*Dangereux. Respecter les précautions d'emploi. Produit conforme à la législation française.



### Liquide de rinçage Eau dure\*

exeol

Permet un séchage rapide de la vaisselle. Laisse une vaisselle sans trace.

Non disponible en Suisse

Bidon de 5 L  **P.U.HT**  
 69636\* E x 6 **24,50 €**

\*Dangereux. Respecter les précautions d'emploi. Produit conforme à la législation française.

## SEL RÉGÉNÉRANT



### Sel en pastilles

Pour une protection longue durée contre le calcaire. Adoucit l'eau et évite les traces de calcaire sur la vaisselle et la verrerie. Protège et assure un fonctionnement régulier et efficace de l'adoucisseur d'eau de votre lave vaisselle. Sans pictogramme de danger. Évite les traces blanches et voile terre.

Sac de 25 kg  **P.U.HT**  
 1001552P x 1 **15,25 €**

nouveau !



### Liquide de rinçage\*

Sun

SUN Professionnel Rinçage s'utilise pour tous les types de lave-vaisselle professionnels à cycle court 5 minutes. Il permet un séchage rapide et laisse la vaisselle et les verres éclatants sans traces. Limite la formation de mousse dans le lave-vaisselle.

Bidon de 5 L  **P.U.HT**  
 1013757P\* x 1 **25,00 €**

\*Dangereux. Respecter les précautions d'emploi. Produit conforme à la législation française.

1<sup>er</sup> PRIX



### Sel en poudre

Protection longue durée contre le calcaire. Adoucit l'eau et évite les traces de calcaire sur la vaisselle et la verrerie. Protège et assure un fonctionnement régulier et efficace de l'adoucisseur d'eau de votre lave vaisselle.

Seau de 10 kg  **P.U.HT**  
 1008380P x 1 **13,20 €**



## VAISSELLE MAINS



### Liquide plonge\*



Pour le lavage et le dégraissage de la vaisselle, verreries, batteries et ustensiles de cuisine. Contient parmi d'autres composants un agent dégraissant d'origine végétale issu du coco.

Non disponible en Suisse

Bidon de 5 kg **P.U.HT**  
 ✓ **69017\*** E x 2 **10,30 €**  
 \* Dangereux. Respecter les précautions d'emploi.  
 Produit conforme à la législation française.



### Liquide plonge manuelle\*



Nettoyant dégraissant pour le lavage de la vaisselle et des ustensiles de cuisine.

Non disponible en Suisse

Bidon de 5 kg **P.U.HT**  
 ✓ **1005069\*** E x 2 **19,25 €**  
 \* Dangereux. Respecter les précautions d'emploi.  
 Produit conforme à la législation française.

## 1<sup>er</sup> PRIX



### Liquide lavage manuel\*

Pour le lavage manuel et le dégraissage de la vaisselle, verreries, batteries et ustensiles de cuisine. Décolle les graisses et résidus tenaces. Parfum citron.

Non disponible en Suisse

Bidon de 5 L **P.U.HT**  
 ✓ **63451P\*** E x 3 **7,00 €**  
 \* Dangereux. Respecter les précautions d'emploi.  
 Produit conforme à la législation française.



Produit non classé

### Liquide vaisselle ultra dégraissant



Fait briller la vaisselle. Respecte la peau. Non parfumé. 100 % naturel et biodégradable.

Flacon de 1 L **P.U.HT**  
**1011625P** E x 1 **5,00 €**



### Liquide vaisselle Enzypin\*



Très efficace en trempage sur salissures incrustées. Respect des mains sensibles, testé sous contrôle dermatologique. Formule sans parfum. 99 % d'ingrédients d'origine naturelle. Ingrédients biodégradables.

Non disponible en Suisse

Flacon de 1 L **P.U.HT**  
**1002595P\*** E x 1 **5,90 €**  
 \* Dangereux. Respecter les précautions d'emploi.  
 Produit conforme à la législation française.



### Liquide vaisselle ultra dégraissant\*



Formule concentrée très dégraissante. Rend la vaisselle brillante et sans traces.

Non disponible en Suisse

Flacon de 1 L **P.U.HT**  
 ✓ **62174P\*** E x 1 **4,90 €**  
 \* Dangereux. Respecter les précautions d'emploi.  
 Produit conforme à la législation française.

Gants voir page 499  
 Éponge voir page 480



## RÉNOVATION VAISSELLE



### Liquide de trempage\*



Pour préparer le passage en machine des vaisselles différées, matériaux sales et très sales. Prépare et optimise le lavage en machine.

Non disponible en Suisse

Bidon de 6 kg **P.U.HT**  
**1007010\*** E x 2 **11,20 €**  
 \* Dangereux. Respecter les précautions d'emploi.  
 Produit conforme à la législation française.



### Rénovateur vaisselle\*



Poudre conçue pour laver, rénover et désincruster les vaisselles (sauf aluminium et vaisselle décorée). Élimine efficacement tanins, vins, café, thé, amidon, résidus alimentaires, par trempage ou lavage en machine.

Non disponible en Suisse

Seau de 10 kg **P.U.HT**  
**69030\*** E x 2 **55,00 €**  
 \* Dangereux. Respecter les précautions d'emploi.  
 Produit conforme à la législation française.

## RÉNOVATION MÉTAUX



### Éclat argent\*

Désoxydation rapide du métal argenté sans l'attaquer. Ôte le sulfure d'argent, les dépôts lessiviels ou calcaires. Rénove l'inox. Sans odeur, ni goût. Économique. Réutilisable plusieurs fois.

Non disponible en Suisse

Bidon de 5 L **P.U.HT**  
 ✓ **50139P\*** E x 1 **86,50 €**  
 \* Dangereux. Respecter les précautions d'emploi.  
 Produit conforme à la législation française.



### Brillant Breton argenterie

Nettoie, dégraisse et fait briller l'argent, les vitres, les glaces et l'inox. Facile. Excellent dégraissant.

Flacon de 1 L **P.U.HT**  
**1000543P** E x 1 **11,20 €**

### Pâte à polir de Buyer

Pâte nettoyante rénovante multi-matériaux pour cuivre, laiton, aluminium. Nettoie, désoxyde, rénove les métaux sans frotter.

Pot de 1,25 kg **P.U.HT**  
**71086** E x 1 **69,00 €**

## DÉGRAISSANTS



### Dégraissant multi-usages



Dégraissant surpuissant, économique et efficace sur tous supports (sols et surfaces). Diffuse un parfum de propreté agréable. 100 % naturel et biodégradable.

Produit non classé



**1011627P** Bidon de 5 L x 2 **P.U.HT 25,00 €**  
**1011626P** Flacon de 1 L x 6 **6,00 €**



### Dégraissant friteuse et hotte\*



Puissant dégraissant composé d'agents alcalins qui permettent de dissoudre les dépôts incrustés. N'attaque pas l'inox, l'acier, l'émail et la fonte.

Non disponible en Suisse

**69031\*** Bidon de 5 kg x 2 **P.U.HT 16,25 €**  
 \* Dangereux. Respecter les précautions d'emploi. Produit conforme à la législation française.

## DÉTARTRANTS MACHINE



### Détartrant machine\*



Spécialement conçu pour le détartrage et l'entretien des machines à laver la vaisselle et le linge.

Non disponible en Suisse

**69022\*** Bidon de 6 kg x 2 **P.U.HT 15,75 €**  
 \* Dangereux. Respecter les précautions d'emploi. Produit conforme à la législation française.

## 1<sup>er</sup> PRIX



### Détartrant machine\*

Détartrant liquide pour le détartrage et l'entretien des machines à laver la vaisselle et le linge.

Non disponible en Suisse

**1011622P\*** Bidon de 5 L x 3 **P.U.HT 9,00 €**  
 \* Dangereux. Respecter les précautions d'emploi. Produit conforme à la législation française.

## 1<sup>er</sup> PRIX



### Dégraissant cuisine\*

Pour le nettoyage et le dégraissage journalier des sols et surfaces lavables.

Non disponible en Suisse

**63457P\*** Bidon de 5 L x 3 **P.U.HT 9,80 €**  
 \* Dangereux. Respecter les précautions d'emploi. Produit conforme à la législation française.

## DÉCAPANTS FOUR



### Décapant four gel\*



Texture gélifiée qui adhère aux parois et facilite le mouillage et le décollement des graisses carbonisées. Particulièrement actif sur les graisses cuites.

Non disponible en Suisse

**69028\*** Bidon de 5 kg x 6 **P.U.HT 17,50 €**  
 \* Dangereux. Respecter les précautions d'emploi. Produit conforme à la législation française.

## 1<sup>er</sup> PRIX



### Décapant four\*

Décapant liquide spécialement conçu pour éliminer et dissoudre les graisses cuites des fours, plaques de cuisson, pianos, filtres, hottes...

Non disponible en Suisse

**63453P\*** Bidon de 5 L x 3 **P.U.HT 10,00 €**  
 \* Dangereux. Respecter les précautions d'emploi. Produit conforme à la législation française.



### Nettoyant dégraissant Mr Proper\*



Anti-graisse cuisine. Elimination rapide des graisses, même tenaces et incrustées.

Non disponible en Suisse

**68722P\*** Spray de 750 ml x 1 **P.U.HT 5,90 €**  
 \* Dangereux. Respecter les précautions d'emploi. Produit conforme à la législation française.



### Dégraissant\*



Élimine les graisses sur tous types de surfaces lavables.

Non disponible en Suisse

**1011621\*** Spray de 750 ml x 6 **P.U.HT 5,60 €**  
 \* Dangereux. Respecter les précautions d'emploi. Produit conforme à la législation française.

## nouveau !



### Nettoyant four et grill\*



Cif Fours et Grills, prêt à l'emploi s'utilise sur les fours, grills, plaques chauffantes et hottes. Il élimine rapidement les graisses et résidus carbonisés.

Non disponible en Suisse

**1013761P\*** Spray de 750 ml x 1 **P.U.HT 5,20 €**  
 \* Dangereux. Respecter les précautions d'emploi. Produit conforme à la législation française.



## NETTOYANTS DÉSINFECTANTS



### Détergent dégraissant désinfectant\*\*

Détergent bactéricide lévuricide pour toutes surfaces. Contact alimentaire.

Non disponible en Suisse

Bidon de 5 L **P.U.HT**  
 ✓ 69029\*\* E x 2 **16,25 €**

\* Dangereux. Respecter les précautions d'emploi. Produit conforme à la législation française.

\*\* Utilisez les biocides avec précaution. Avant toute utilisation, lisez l'étiquette et les informations concernant le produit.



### Dégraissant désinfectant\*\*

Super dégraissant économique, efficace sur tous supports (sols et surfaces). Contact alimentaire. Bactéricide EN1276. 100 % naturel et biodégradable.

Non disponible en Suisse

Bidon de 5 L **P.U.HT**  
 ✓ 1011628P\*\* E x 2 **20,00 €**

\*\* Utilisez les biocides avec précaution. Avant toute utilisation, lisez l'étiquette et les informations concernant le produit.

Produit non classé



### Nettoyant désinfectant\*\*

Nettoie, désinfecte et désodorise très efficacement les surfaces. Bactéricide, levuricide, virucide EN1276/EN1275/EN14476. 100 % naturel et biodégradable.

Non disponible en Suisse

Spray de 750 ml **P.U.HT**  
 ✓ 1011631P\*\* E x 6 **7,00 €**

\*\* Utilisez les biocides avec précaution. Avant toute utilisation, lisez l'étiquette et les informations concernant le produit.

Produit non classé

nouveau !



### Nettoyant Cif 2 en 1\*\*

Détergent désinfectant prêt à l'emploi, sans parfum. Particulièrement efficace sur un large spectre de micro-organismes et pour éliminer les graisses et aliments séchés. Bactéricide selon la norme EN1276.

Non disponible en Suisse

Spray de 750 ml **P.U.HT**  
 ✓ 1013760P\*\* E x 1 **4,80 €**

\* Dangereux. Respecter les précautions d'emploi. Produit conforme à la législation française.  
 \*\* Utilisez les biocides avec précaution. Avant toute utilisation, lisez l'étiquette et les informations concernant le produit.

### Détergent désinfectant Bactopin+\*\*

Détergent désinfectant pour tous types de surfaces et mobiliers. Apte au contact alimentaire après rinçage à l'eau potable.

Non disponible en Suisse

Spray de 750 ml **P.U.HT**  
 ✓ 1006582P\*\* E x 1 **6,90 €**

\*\* Utilisez les biocides avec précaution. Avant toute utilisation, lisez l'étiquette et les informations concernant le produit.

### Détergent désinfectant vitres et surfaces\*\*

Action bactéricide (conforme à la norme EN1040).

Non disponible en Suisse

Spray de 750 ml **P.U.HT**  
 ✓ 66020P\*\* E x 1 **5,00 €**

\*\* Utilisez les biocides avec précaution. Avant toute utilisation, lisez l'étiquette et les informations concernant le produit.



### Nettoyant dégraissant\*

Désincruste en profondeur.

Non disponible en Suisse

Spray de 750 ml **P.U.HT**  
 ✓ 1005068\* E x 6 **5,80 €**

\* Dangereux. Respecter les précautions d'emploi. Produit conforme à la législation française.



### Lingette désinfectante\*\*

Pour la désinfection sans rinçage des vitres, vitrines réfrigérées, surfaces et matériels pouvant entrer en contact avec les denrées alimentaires, actif dès 30 s.

Boîte de 200 lingettes **P.U.HT**  
 ✓ 1007072P\*\* E x 1 **33,75 €**

\* Dangereux. Respecter les précautions d'emploi. Produit conforme à la législation française.

\*\* Utilisez les biocides avec précaution. Avant toute utilisation, lisez l'étiquette et les informations concernant le produit.

Non disponible en Suisse

## DÉSINFECTANTS DÉSODORISANTS



### Dégraissant désinfectant désodorisant 4D\*\*

Bactéricide EN1040, EN1276 et EN1275. 100 % naturel et biodégradable.

Non disponible en Suisse

Bidon de 5 L **P.U.HT**  
 ✓ 1011630P\*\* E x 2 **25,00 €**  
 Flacon de 1 L x 6 **6,00 €**

\*\* Utilisez les biocides avec précaution. Avant toute utilisation, lisez l'étiquette et les informations concernant le produit.

nouveau !



### Doses 3D\*\*

Détergent Désinfectant Désodorisant, pour l'entretien quotidien de toutes les surfaces.

Non disponible en Suisse

Carton de 250 doses **P.U.HT**  
 ✓ 1013683P\*\* E 20 ml x 1 **25,25 €**

\* Dangereux. Respecter les précautions d'emploi. Produit conforme à la législation française.

\*\* Utilisez les biocides avec précaution. Avant toute utilisation, lisez l'étiquette et les informations concernant le produit.



### Détergent en monodose\*\*

Pour toutes surfaces. Sans rinçage. PH neutre.

DDS : détergent désinfectant surodorant.

Non disponible en Suisse

Carton de 250 doses **P.U.HT**  
 ✓ 1000180P\*\* E 15 ml x 1 **81,50 €**

\* Dangereux. Respecter les précautions d'emploi. Produit conforme à la législation française.

\*\* Utilisez les biocides avec précaution. Avant toute utilisation, lisez l'étiquette et les informations concernant le produit.

1<sup>er</sup> PRIX



### Détergent désinfectant odorant\*\*

Nettoyage, désinfection et désodorisation de tous les supports lavables. Parfum frais Eucalyptus.

Non disponible en Suisse

Bidon de 5 L **P.U.HT**  
 ✓ 1005044P\*\* E x 3 **10,00 €**

\* Dangereux. Respecter les précautions d'emploi. Produit conforme à la législation française.

\*\* Utilisez les biocides avec précaution. Avant toute utilisation, lisez l'étiquette et les informations concernant le produit.

nouveau !



### Dégraissant\*

Pour toutes les surfaces en cuisine et laboratoire de fabrication.

Non disponible en Suisse

Bidon de 5 L **1013756P\*** x 1 P.U.HT **18,00 €**

\*Dangereux. Respecter les précautions d'emploi. Produit conforme à la législation française.



### Dégraissant M. Proper\*

Nettoie et dégraisse toutes les surfaces lavables.

Bidon de 5 L **61641P\*** x 1 P.U.HT **13,20 €**

\*Dangereux. Respecter les précautions d'emploi. Produit conforme à la législation française.



Non disponible en Suisse



### Nettoyant superpuissant\*

Détergent dégraissant universel concentré qui permet d'éliminer les salissures et graisses les plus tenaces.

Bidon de 5 L **1011388P\*** x 1 P.U.HT **20,25 €**

\*Dangereux. Respecter les précautions d'emploi. Produit conforme à la législation française.



### Spray nettoyant\*

Nettoyant écologique qui détartre, dégraisse et fait briller toutes les surfaces en inox.

Spray de 750 ml **1011620\*** x 6 P.U.HT **7,00 €**

\*Dangereux. Respecter les précautions d'emploi. Produit conforme à la législation française.



Non disponible en Suisse



### Détergent Bio ménage\*

Nettoie, dégraisse et odorise sans mousser. Laisse une odeur agréable et fraîche.

Bidon de 5 L **1002596P\*** x 1 P.U.HT **13,10 €**

\*Dangereux. Respecter les précautions d'emploi. Produit conforme à la législation française.



nouveau !

### Nettoyage des surfaces\*

Elimine les salissures, les graisses et les marques de doigts sur les surfaces en cuisine.

Spray de 750 ml **1013762P\*** x 1 P.U.HT **5,20 €**

\*Dangereux. Respecter les précautions d'emploi. Produit conforme à la législation française.



Non disponible en Suisse



### Détergent\*

Détergent multi-usages pour le nettoyage de toutes les surfaces lavables.

Bidon de 5 L **1008320P\*** E x 2 P.U.HT **10,10 €**  
**1008321P\*** x 48 **10,10 €**

\*Dangereux. Respecter les précautions d'emploi. Produit conforme à la législation française.



1er PRIX



### Détergent\*

Nettoyage quotidien des sols et surfaces lavables à l'eau. Propriétés émulsifiantes et détergentes. Parfum frais menthe.

Non disponible en Suisse

Bidon de 5 L **1008374P\*** E x 3 P.U.HT **6,10 €**

\*Dangereux. Respecter les précautions d'emploi. Produit conforme à la législation française.



### Nettoyant\*

Nettoyant dégraissant alcalin concentré.

Non disponible en Suisse

Bidon de 5 L **1005071\*** x 2 P.U.HT **14,70 €**

\*Dangereux. Respecter les précautions d'emploi. Produit conforme à la législation française.



Produit non classé



### Nettoyant surfaces\*\*

Nettoie, désinfecte et désodorise très efficacement les surfaces. Bactéricide, levuricide, virucide EN1276/EN1275/EN14476. 100 % naturel et biodégradable.

Spray de 750 ml **1011631P\*\*** E x 6 P.U.HT **7,00 €**

\*\* Utilisez les biocides avec précaution. Avant toute utilisation, lisez l'étiquette et les informations concernant le produit.



Produit non classé



### Dégraissant surfaces

Dégraissant surpuissant. Efficace sur tous supports (surfaces et moquettes). Désodorise agréablement. 100 % naturel et biodégradable.

Spray de 750 ml **1011632P** x 6 P.U.HT **5,00 €**



Produit non classé



### Absorbant neutralisant

Absorbant en poudre pour tous les liquides. Désodorise agréablement et supprime les mauvaises odeurs. Dégrade les matières organiques, utilisable sur tous supports, ne tâche pas. 100 % naturel et biodégradable.

Pot de 500 ml **1011633P** x 1 P.U.HT **11,60 €**



## JAVEL

Non disponible en Suisse



### Cruchons de javel à 9,6 %\*\*

Blanchit, désinfecte et assainit. Bactéricide, fongicide, sporicide et virucide. 1 cruchon de 250 ml d'extrait de javel diluée dans 750 ml d'eau = 1 litre d'eau de javel.

Carton de 40 cruchons **55689P\*\*** 250 ml x 1 P.U.HT **15,00 €**

Non disponible en Suisse



### Pastille de chlore\*\*

Blanchit, désinfecte et assainit. Bactéricide, fongicide sporicide et virucide. 1 pastille pour 10 litres d'eau. Conservation illimitée et manipulation sans danger.

300 pastilles **127268P\*\*** Boîte de 1 kg x 1 P.U.HT **13,80 €**



### Eau de javel à 2,6 %\*\*

Blanchit, désinfecte et assainit. Bactéricide, fongicide, sporicide et virucide.

Non disponible en Suisse

Bidon de 5 L **55677P\*\*** E x 3 P.U.HT **3,00 €**

\*Dangereux. Respecter les précautions d'emploi. Produit conforme à la législation française.

\*\* Utilisez les biocides avec précaution. Avant toute utilisation, lisez l'étiquette et les informations concernant le produit.



## NETTOYANTS SANITAIRES



**Spray nettoyant sanitaire\***

Pour l'entretien quotidien des surfaces sanitaires.

Non disponible en Suisse

Spray de 750 ml **1005070\*** x 6 **P.U.HT 5,20 €**

\*Dangereux. Respecter les précautions d'emploi. Produit conforme à la législation française.



**Gel détartrant sanitaire\***

Puissant nettoyeur détartrant. Bec arrondi pour les zones difficiles d'accès.

Non disponible en Suisse

Flacon de 750 ml **1005072\*** x 12 **P.U.HT 4,50 €**

\*Dangereux. Respecter les précautions d'emploi. Produit conforme à la législation française.



### Gel nettoyant sanitaire

Super nettoyeur antitartre. Brillance éclatante. Destruction des odeurs à la source. Parfum de propreté rémanant, laisse un film protecteur. Entretien des canalisations et les fosses. 100 % naturel et biodégradable.

Produit non classé

Flacon de 1 L **1011639P** x 6 **P.U.HT 10,00 €**



### Nettoyant détartrant et désinfectant\*\*

Nettoyant désincrustant surpuissant. Brillance éclatante. Détartre très efficacement tout en préservant le support. Bactéricide et levuricide EN1076/EN1275. Parfum d'origine naturelle. 100 % naturel et biodégradable.

Produit non classé

Bidon de 5 L **1011641P\*\*** x 2 **P.U.HT 30,00 €**  
 Spray de 750 ml **1011640P\*\*** x 6 **P.U.HT 8,00 €**

\*\*Utilisez les biocides avec précaution. Avant toute utilisation, lisez l'étiquette et les informations concernant le produit.

Non disponible en Suisse

### Nettoyant sanitaire\*\*

Nettoyant acide et bactéricide. Pour entretien courant et désinfection des sanitaires.

Non disponible en Suisse

Spray de 750 ml **1005345P\*\*** x 1 **P.U.HT 4,00 €**

\*Dangereux. Respecter les précautions d'emploi. Produit conforme à la législation française.

\*\*Utilisez les biocides avec précaution. Avant toute utilisation, lisez l'étiquette et les informations concernant le produit.



## GELS WC

**Gel WC 4D\*\***

Super nettoyeur et détartrant. Brillance éclatante. Bactéricide EN1040. Désodorise agréablement. Formule gélifiée pour une action prolongée. 100 % naturel et biodégradable.

Produit non classé

Flacon de 750 ml **1011642P\*\*** x 6 **P.U.HT 3,90 €**

\*\*Utilisez les biocides avec précaution. Avant toute utilisation, lisez l'étiquette et les informations concernant le produit.



### Gel wc\* Mr Proper

Non disponible en Suisse

Flacon de 750 ml **60681P\*** E x 1 **P.U.HT 4,10 €**

\*Dangereux. Respecter les précautions d'emploi. Produit conforme à la législation française.

### 1<sup>er</sup> PRIX



### Gel wc\*

Pour WC, urinoirs, robinetteries et lavabos. Elimine les dépôts difficiles. Respecte toutes les surfaces.

Non disponible en Suisse

Flacon de 1L **1008381P\*** x 1 **P.U.HT 2,40 €**

\*Dangereux. Respecter les précautions d'emploi. Produit conforme à la législation française.



### Cube Urinoir

Nettoyage et parfumage des urinoirs. Effet moussant. Ne contient pas de paradichlorobenzène : idéal en collectivité. Adapté pour les fosses septiques.

Boîte de 40 cubes **56787P** x 1 **P.U.HT 12,40 €**

## ACCESSOIRES

### Brosse WC

En polypropylène. Pot rond + brosse boule vrac coloris blanc.

Ensemble **70202P** L. 35 x l. 14 cm x 1 **P.U.HT 2,90 €**

Brosse seule **39677P** L. 35 x l. 14 cm x 1 **P.U.HT 1,90 €**



### Abattant wc

Conception privilégiant résistance et longévité.

**1007729P** L. 46 x l. 37 cm x 1 **P.U.HT 23,25 €**

## ANTI-CALCAIRE / CRÈME À RÉCURER



### Spray Antikal\*

Spray détartrant puissant pour les robinetteries, douches, baignoires, toilettes, urinoirs, carrelages muraux. Élimine les traces et dépôts de calcaire incrustés.



Non disponible en Suisse

Spray de 750 ml  **P.U.HT**  
**1007756P\*** x 1 **4,10 €**

\* Dangereux. Respecter les précautions d'emploi. Produit conforme à la législation française.

1<sup>er</sup> PRIX



### Crème à récurer\*

Destinée au nettoyage et à l'entretien des surfaces telles que l'émail ou l'inox. Dégraisse et détartré efficacement. Fait briller sans rayer.

Non disponible en Suisse

Flacon de 1 L  **P.U.HT**  
**1008376P\* E** x 1 **2,10 €**

\* Dangereux. Respecter les précautions d'emploi. Produit conforme à la législation française.

## ENTRETIEN DES CANALISATIONS



### Nettoyant désodorisant

Détruit immédiatement les mauvaises odeurs. Désodorise agréablement et durablement. Entretien des canalisations. Peut aussi être utilisé pour le nettoyage des sanitaires et textiles. 100 % naturel et biodégradable.



Produit non classé 

Bidon de 1 L  **P.U.HT**  
**1011643P** x 6 **10,00 €**

1<sup>er</sup> PRIX



### Déboucheur acide\*

Pour toutes canalisations.

Non disponible en Suisse

Bidon de 1 L  **P.U.HT**  
**1011623P\*** x 4 **6,00 €**

\* Dangereux. Respecter les précautions d'emploi. Produit conforme à la législation française.

## ENTRETIEN DES CANALISATIONS



### Déboucheur manuel

Ø 14,5 x H. 38,5 cm  **P.U.HT**  
**69113P** x 1 **5,80 €**

## TRAITEMENT DES ODEURS SANITAIRES



### Grille pour urinoir

Cette grille libère un agréable parfum et donne une odeur fraîche aux urinoirs jusqu'à 30 jours. Elle est dotée d'une texture anti-éclaboussures innovante qui permet de maintenir l'urinoir propre et utilise une technologie qui élimine les odeurs agressives notamment grâce à une substance qui absorbe les mauvaises odeurs. Parfum citron.

Boîte de 12  **P.U.HT**  
**1008305P** x 2 **38,00 €**

### Assainisseur d'air

Peut être fixé sur n'importe quelle surface dure. Avec des matériaux microporeux qui éliminent les mauvaises odeurs, V FRESH rafraîchit l'air tout en neutralisant les mauvaises odeurs. Sans solvants, ni gaz propulsif. Efficacité 1 mois.



Boîte de 12  **P.U.HT**  
**1011240P** Parfum x 1 **46,25 €**  
**1011241P** Citrus Mango x 1 **46,25 €**  
Parfum Océan spray

### Odorisant WC\*

S'utilise directement dans la cuvette des toilettes. Odorise durablement et fait briller la cuvette des toilettes.

Non disponible en Suisse

Spray de 750 ml  **P.U.HT**  
**66019P\*** x 1 **7,10 €**

\* Dangereux. Respecter les précautions d'emploi. Produit conforme à la législation française.



## BOIS

nouveau !

### Nettoyant bois



Cif Nettoyant Polissant Bois, avec son mélange unique de cires, dépeussière, détache et élimine les traces de doigts. Laisse les surfaces brillantes, s'utilise aussi sur toutes les surfaces modernes : (ne pas utiliser sur les meubles cirés).



Spray de 750 ml **1013763P** x 1 **P.U.HT 6,80 €**



### Mouilleur

En coton / polyester.

**1001524P** L. 35 cm x 1 **P.U.HT 13,90 €**  
**1001525** Recharge x 10 **7,40 €**

### Raclette

Taille idéale pour les vitres et plans de travail. Ne laisse pas de traces. Tête inox. Poignée avec caoutchouc antidérapant.



**1001527P** E L. 25 cm x 1 **P.U.HT 9,70 €**

### Grattoir

En polypropylène et métal.



Grattoir avec lame **1001521P** L. 20 x l. 10 cm x 1 **P.U.HT 19,25 €**

Boîte de 25 **1001519P** Lames acier 10 cm x 1 **P.U.HT 28,50 €**

## VITRES

### Nettoyant vitres



Nettoie toutes les surfaces lisses. Séchage rapide et sans traces. Anticalcaire. 100 % naturel et biodégradable.



Produit non classé



**1011638P** Bidon de 5 L x 2 **P.U.HT 15,00 €**  
**1011637P** Spray de 750 ml x 6 **4,00 €**

## TRAITEMENT DES ODEURS

### Désodorisant d'air Fébreze



Désodorisant d'intérieur frais et léger. Élimination des odeurs tenaces sans les masquer et rafraîchissement de l'air.

Non disponible en Suisse



Aérosol de 300 ml **1000105P\*** Parfum fleur x 1 **P.U.HT 6,10 €**  
**1000106P\*** Parfum rosée du matin x 1 **5,90 €**

\*Dangereux. Respecter les précautions d'emploi. Produit conforme à la législation française.

### Destructeur d'odeurs



Désodorise agréablement et durablement. Performant à l'intérieur comme à l'extérieur. 100 % naturel et biodégradable.

Produit non classé



**1011636P** Flacon de 1 L x 6 **P.U.HT 12,00 €**

nouveau !

### Nettoyant vitres et multi-surfaces



Prêt à l'emploi. Contient des solvants, élimine rapidement les salissures et graisses. Fait briller les vitres et surfaces modernes (miroirs, tables, vitrines alimentaires).



**1013758P** Bidon de 5 L x 1 **P.U.HT 14,10 €**  
**1013764P** Spray de 750 ml x 1 **4,40 €**

1<sup>er</sup> PRIX

### Nettoyant vitres

Pour le nettoyage quotidien des vitres et surfaces modernes. Sans pictogramme de danger.



**1008375P** Bidon de 5 L x 3 **P.U.HT 4,30 €**  
**1008379P** Spray de 750 ml x 6 **2,00 €**

1<sup>er</sup> PRIX

### Désodorisant\*

Sa formulation sèche et très concentrée permet par quelques pulvérisations de parfumer et rafraîchir agréablement vos espaces.

Non disponible en Suisse



Aérosol de 750 ml **62698P\*** x 1 **P.U.HT 6,80 €**

\*Dangereux. Respecter les précautions d'emploi. Produit conforme à la législation française.



## LESSIVES LIQUIDES



### Ariel dosette 3 en 1\*

Lessive liquide professionnelle super concentrée en dosette multi-compartiments.

Non disponible en Suisse

Boîte de 42 doses x 2 **P.U.HT**  
**1011243P\*** 2,8 kg x 1 **56,50 €**

\*Dangereux. Respecter les précautions d'emploi. Produit conforme à la législation française.



### Skip Bag in Box\*

Liquide de lavage pour le linge concentré. Tous textiles. Boule doseuse intégrée.

Non disponible en Suisse

Box de 100 doses **P.U.HT**  
**1011389P\*** 7,5 L x 1 **30,25 €**

\*Dangereux. Respecter les précautions d'emploi. Produit conforme à la législation française.



### Ariel Actilift\*

Nouvelle formule professionnelle 5 en 1. Sans phosphates. Parfum subtil et discret.

Non disponible en Suisse

Bidon de 85 doses **P.U.HT**  
**69735P\*** 6 L x 1 **43,75 €**

\*Dangereux. Respecter les précautions d'emploi. Produit conforme à la législation française.

## 1<sup>er</sup> PRIX



### Lessive Soapy Wash\*

Sans phosphate. Adaptée pour tous textiles et en particulier pour les synthétiques. Efficace dès les basses températures (30°C/ 40°C). Parfum savon de Marseille.

Non disponible en Suisse

Bidon de 5 L **P.U.HT**  
**1008365P\*** x 1 **14,20 €**

\*Dangereux. Respecter les précautions d'emploi. Produit conforme à la législation française.

## DÉTACHANT / DÉSODORISANT



### Spray détachant Stain wash Power\*

Détachant linge efficace sur les taches grasses sur tous types de textile.

Non disponible en Suisse

Spray de 750 ml **P.U.HT**  
**1004485P\*** x 1 **8,20 €**

\*Dangereux. Respecter les précautions d'emploi. Produit conforme à la législation française.



### Désodorisant textile Febreze

Élimine les odeurs incrustées dans les textiles.

Non disponible en Suisse

Spray de 750 ml **P.U.HT**  
**1000107P** x 1 **6,90 €**

## LESSIVES POUDRE



### Ariel Professionnel\*

Formule conçue pour d'excellents résultats dès le premier lavage.

Non disponible en Suisse

Seau de 142 doses **P.U.HT**  
**1009405P\*** 12,6 kg x 1 **86,00 €**

\*Dangereux. Respecter les précautions d'emploi. Produit conforme à la législation française.



### Ariel Professionnel\*

Efficace dès les basses températures. Parfum frais.

Non disponible en Suisse

Carton de 125 doses **P.U.HT**  
**66594P\*** 10,4 Kg x 1 **69,50 €**

\*Dangereux. Respecter les précautions d'emploi. Produit conforme à la législation française.

## nouveau !



### Omo\*

Omo professionnel concentré. Spécialement formulé pour les métiers de bouche, la restauration et l'hôtellerie. Efficace dès les basses températures. Tous textiles.

Non disponible en Suisse

Carton de 110 doses **P.U.HT**  
**1013759P\*** 7,7 kg x 1 **29,25 €**

\*Dangereux. Respecter les précautions d'emploi. Produit conforme à la législation française.

### Lessive désinfectante Bactitop\*\*

Blanc et couleurs grand teint, désinfectante EN 1276. Sans phosphates, étudiée pour le lavage de tous les textiles à toutes températures. Commercialisé uniquement en France.

Commercialisé uniquement en France

Sac de 15 kg **P.U.HT**  
**1004484P\*\*** x 1 **41,00 €**

\*Dangereux. Respecter les précautions d'emploi. Produit conforme à la législation française.

\*\* Utilisez les biocides avec précaution. Avant toute utilisation, lisez l'étiquette et les informations concernant le produit.

## 1<sup>er</sup> PRIX



### Lessive poudre\*

Lessive poudre sans phosphate pour le lavage du linge en machine semi professionnelle. Pour tous les textiles et programmes de lavage.

Non disponible en Suisse

Sac de 20 kg **P.U.HT**  
**1011624P\*** x 1 **30,25 €**

\*Dangereux. Respecter les précautions d'emploi. Produit conforme à la législation française.



Récurage courant



### Tamponne vert 3M

En éponge 100% cellulosique. Absorbant, dure longtemps. Détache les résidus alimentaires brûlés. Forme ergonomique.

Sachet de 6  
✓ 1001397P L. 13 x l. 8,2 cm x 1 P.U.HT 9,70 €

### Tamponne abrasif sur éponge

Éponge végétale cellulosique. Pour surfaces non fragiles.

Sachet de 10  
✓ 1001392P L. 13 x l. 9 cm x 1 P.U.HT 10,00 €

### Tamponne vert 3M A.C.C.P.

Éponge cellulosique. Résiste à l'eau chaude et détergents courants.

Sachet de 10  
✓ 1001398P E L. 11 x l. 7 cm x 1 P.U.HT 7,60 €

Récurage doux

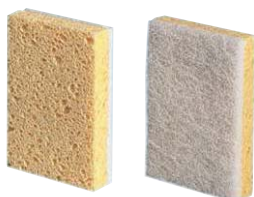

### Tamponne blanc

Spécial sanitaire. Gratte sans rayer et absorbe.

Paquet de 10  
✓ 53135P L. 13 x l. 9 cm x 1 P.U.HT 12,20 €

Pour petits nettoyages



### Éponge Spontex Azella

100% végétale. Très résistante à la torsion et au déchirement.

Paquet de 10  
✓ 48391P E L. 14,4 x l. 10 cm x 1 P.U.HT 12,00 €

Récurage courant



### Tamponne abrasif 3M A.C.C.P.

Utilisé humide ou à sec pour récurer les plats et les casseroles, nettoyer les rôtissoires et la plupart des ustensiles de cuisine. Il permet également d'effectuer divers travaux de nettoyage manuel dans les bâtiments (sols, escaliers, bureaux, comptoirs...)

Paquet de 20  
✓ 1008366P L. 19 x l. 15,8 cm x 1 P.U.HT 25,25 €

L'abrasif vert : récurages courants : casseroles, poêles...  
L'abrasif noir : récurages difficiles : grille barbecue, décapage, piano...

Récurage difficile



### Tamponne abrasif

Ces abrasifs ont un très fort pouvoir décapant et sont destinés aux récurages difficiles (nettoyage des pianos, plaques de cuisson, grills à chaud jusqu'à 100°C).

Paquet de 10  
✓ 1006685P L. 22,5 x l. 14 cm x 1 P.U.HT 11,80 €

Récurage intensif des surfaces dures



### Boule inox

Boule constituée d'un fil acier inoxydable. Pour les récurages difficiles en vaisselle et surfaces dures.

Paquet de 10  
✓ 1001396P E 60g x 1 P.U.HT 12,10 €  
✓ 1001395P E 40g x 1 P.U.HT 9,00 €

Récurage très difficile



### Tamponne noir 3M A.C.C.P.

La poignée tampon Hi-Pro est un outil de nettoyage composé d'une mousse absorbante et d'un côté abrasif au pouvoir récurant ultra-puissant, même sur la nourriture brûlée. La mousse a une forme ergonomique facilitant son utilisation et sa prise en main. Ne contient pas de particules métalliques.

Paquet de 6  
✓ 69633P L. 13 x l. 7 cm x 1 P.U.HT 15,50 €



Récurage intensif des surfaces chaudes

### Poignée scotchbrick 3M

Utilisable jusqu'à 100 °C. Pour plan de travail et plaques de cuisson.



Paquet de 4  
✓ 61646P L. 15,2 x l. 10 cm x 3 P.U.HT 41,00 €

### Efface taches 3M

L'Efface-Tache Plus Large Scotch-Brite est un outil de nettoyage de forme ergonomique destiné à retirer efficacement traces et salissures sur une grande variété de surfaces. Il nettoie de nombreuses surfaces sans ajout de produit chimique, de l'eau suffit.

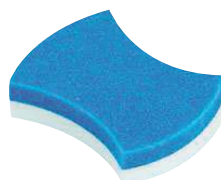

Paquet de 4  
✓ 1000408P L. 11,4 x l. 6,6 cm x 3 P.U.HT 5,70 €



## DÉPOUSSIÉRAGE

nouveau !



### Delta-Flex

Outil à mémoire de forme multidirectionnel pour le dépeussierage et le nettoyage des surfaces difficiles d'accès. Mini-manche télescopique avec globe rotatif pour la réduction des TMS. Poids 460 g.

Manche et lame  **P.U.HT**  
**1013391P** L. 115 x l. 146 cm x 1 **32,75 €**



### Housse Delta-Flex

La microfibre structure en Z, offre une performance optimisée pour capter la poussière. Parfaite compatibilité avec les appareils vapeur. Ne peluche pas. Ne pas utiliser de chlore et d'adoucissant.

Housse microfibre  **P.U.HT**  
**1013387P** L. 7,5 x l. 54 cm x 2 **12,40 €**



### Scrub & Wipe

Lavette microfibre double face, une face grattante pour décrocher les salissures et une absorbante pour nettoyer les résidus. S'utilise à sec ou humide. Ne pas utiliser de chlore et d'adoucissant. 311 g/m<sup>2</sup>.

Lavette microfibre  **P.U.HT**  
**1013386P** L. 30 x l. 30 cm x 2 **3,40 €**

## LAVETTES



### Lavette microfibre



80 % polyester et 20 % polyamide. 280 g/m<sup>2</sup>. Limite la consommation de détergents. Résiste jusqu'à 300 lavages. Convient pour tous les essuyages et nettoyages de surfaces lisses. L. 40 x l. 40 cm

Sachet de 5  **P.U.HT**  
 **1000412P** Vert x 1 **10,00 €**  
 **1000411P** Rouge x 1 **10,00 €**  
 **1000410P** Bleu x 1 **10,00 €**

### Lavette non tissée

70% viscose, 30% polyester. Lavette à structure alvéolaire : récupère très bien les salissures, se rince facilement et sèche rapidement. 5 coloris au choix pour la prévention de la contamination croisée. Lavable à 95°C, température de lavage recommandée : 60°C. Jusqu'à 15 lavages. Bonne résistance aux produits détergents et désinfectants. 80 g/m<sup>2</sup>. L. 51 x l. 36 cm.



Paquet de 25  **P.U.HT**  
 **65236P** E Bleu x 1 **7,00 €**  
 **65238P** E Jaune x 1 **7,00 €**  
 **65239P** E Vert x 1 **7,00 €**  
 **65240P** E Blanc x 1 **7,00 €**  
 **65237P** E Rose x 1 **7,00 €**

### Lavette éponge

Pure cellulose à pouvoir très absorbant. 300 g/m<sup>2</sup>. Super souple. Utilisation humide.

Paquet de 10  **P.U.HT**  
 **53130P** L. 31 x l. 30 cm x 1 **12,00 €**



### Lavette comptoir

En coton 360 g/m<sup>2</sup>. Gaufrée blanche.

Paquet de 10  **P.U.HT**  
**49576P** L. 70 x l. 30 cm x 1 **14,10 €**

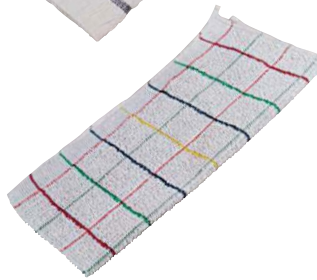

### Lavette bouclée

65% coton. 360 g/m<sup>2</sup>.

Paquet de 10  **P.U.HT**  
**49577P** L. 35 x l. 33 cm x 1 **13,40 €**



### Gaze

Gaze rose non-tissée, imprégnée d'huile minérale. Pour poussière, moutons, miettes...

Carton de 1000  **P.U.HT**  
**1001516P** L. 60 x l. 30 cm x 1 **86,50 €**

## MATÉRIEL



### Bassine

En polyéthylène basse densité. Gris.

11 L  **P.U.HT**  
**49593P** Ø 38 x H. 14 cm x 1 **4,40 €**



### Cuvette carrée

En polypropylène. Bleu.

9 L  **P.U.HT**  
**1001520P** L. 32 x l. 32 cm x 1 **5,40 €**



### Cuvette

En PEBD. Blanc.

14 L  **P.U.HT**  
**39594** E Ø 43 cm x 1 **11,20 €**



### Seau à bec gradué

Avec anse métallique. Emboîtable.

12 L  **P.U.HT**  
**55116** E Ø 36 x H. 31,5 cm x 1 **17,50 €**

1<sup>er</sup> PRIX



### Seau

En polyéthylène. Avec anse en acier galvanisé. Bleu.

10 L  **P.U.HT**  
**1002298P** E Ø 28 x H. 26 cm x 1 **5,50 €**



### Vaporisateur

En polyéthylène. Une couleur par produit.

650 ml  **P.U.HT**  
 **49313P** E Rouge x 1 **2,90 €**  
 **49314P** E Bleu x 1 **2,90 €**



# BROSSERIE ALIMENTAIRE

nouveau !

## Kit de lavage à plat

Kit composé d'un manche télescopique avec globe rotatif antidérapant, pour réduire les TMS et de 2 bandeaux de lavage microfibre.



**1013390P** L. 100 à 180 cm x 1 **P.U.HT 63,50 €**

## Bandeau dépolissage

Bandeau microfibre velcro qui s'utilise sec pour le dépolissage ou légèrement humide pour dégraisser (sols, murs et plafonds). Ne pas utiliser de chlore et d'adoucissant.



**1013388P** L. 45 x l. 11,5 cm x 1 **P.U.HT 6,30 €**

## Bandeau lavage microfibre

Bandeau de lavage microfibre deux en un. S'utilise en bandeau de dépolissage du côté vert et en lavage sur le côté rouge. La partie rouge composée de polypropylène permet un récurage et dégraisage en profondeur des sols, murs et plafonds. Ne pas utiliser de chlore et d'adoucissant.



**1013389P** L. 48 x l. 14 cm x 5 **P.U.HT 9,00 €**

## Pichet doseur

Avec poignée et une graduation adaptée à la pré-imprégnation des produits Delta facilitant ainsi la préparation des solutions.



**1L**  
**1013392** Ø 12,5 cm x 1 **P.U.HT 7,00 €**

## Balai et frottoir

Balai souple



**49788P** E Bleu - L. 38 cm x 1 **P.U.HT 17,75 €**  
**1000775** E Bleu - L. 29 cm x 10 **10,70 €**  
**49785P** E Blanc - L. 29 cm x 1 **13,20 €**  
**39627P** E Blanc - L. 30 cm x 1 **20,50 €**  
**69111P** E Bleu - L. 30 cm x 1 **21,25 €**

Frottoir dur



**1000773** E Rouge - L. 30 cm x 1 **P.U.HT 22,25 €**  
**2593P** E Blanc - L. 25 cm x 1 **13,00 €**  
**43553P** E Bleu - L. 25 cm x 1 **13,60 €**

## Raclette

Monture en polypropylène, fibre en polyester.



**Raclette sol**  
**1001543P** E Bleu - L. 50 cm x 1 **P.U.HT 19,50 €**



**Raclette comptoir**  
**1001542P** E Bleu - L. 35 cm x 1 **P.U.HT 18,75 €**

## Manche recommandé

L. 1,4 m, embout vis.



**Manche aluminium.**  
**1001541P** E Ø 2,35 cm x 1 **P.U.HT 10,20 €**

**Manche fibre de verre**  
**50075P** E Ø 2,4 cm x 1 **P.U.HT 12,40 €**

## Raclette sol

Monture polypropylène.

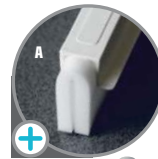

**A 1001547P** E L. 45 cm x 1 **P.U.HT 4,80 €**



**B 1001546P** E L. 55 cm x 1 **P.U.HT 11,00 €**



**B 1001545P** E L. 75 cm x 1 **P.U.HT 14,30 €**

## Manche recommandé

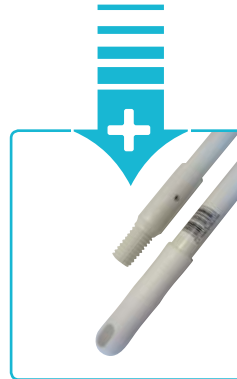

**Manche fibre de verre**  
**49778P** E Ø 2,35 cm - L. 1,40 m x 1 **P.U.HT 12,30 €**

## Brosse papillon

Monture en polypropylène. Mi-dure. L. 24 cm.



**59676** Blanc x 1 **P.U.HT 10,50 €**



**1000768** Rouge x 1 **P.U.HT 13,80 €**



**1000770** Bleu x 1 **P.U.HT 13,80 €**

## Brosse à manche

Fibres mi-dures.



**2603** E L. 26 cm x 10 **P.U.HT 12,00 €**

## Brosse à mains et à ongles

Monture en polypropylène, fibre polyester.



**59447P** E L. 13 x 6 cm x 1 **P.U.HT 3,30 €**



**Chainette inox**  
**59446P** E L. 50 cm x 1 **P.U.HT 9,00 €**

BROSSERIE ALIMENTAIRE



HYGIÈNE ET ENTRETIEN

# BROSSERIE TRADITIONNELLE

## Balai



Balai coco

Monture polypropylène  
**1001539P** L. 29 cm x 1 **P.U.HT 2,80 €**



Balai soie de chine

Monture polypropylène  
**1001517P** L. 37,5 cm x 1 **P.U.HT 8,30 €**

## Manche recommandé

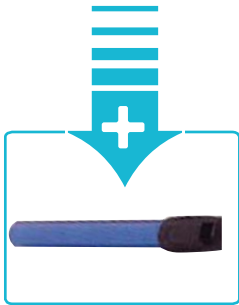

Manche métal bleu

**50071P** Ø 2,4 cm. L. 1,20 m x 1 **P.U.HT 1,40 €**



Frottoir

Fibre nylon. Monture façon hêtre  
**50099** L. 38 cm x 20 **P.U.HT 7,10 €**



Lave pont

Fibre nylon. Monture façon hêtre  
**1012602P** L. 22 cm x 1 **P.U.HT 2,90 €**

## Manche recommandé

Embout vis.

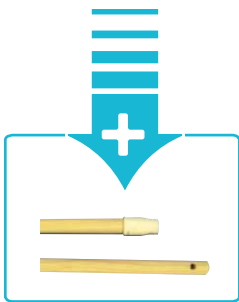

Manche bois

**1001523P** Ø 2,35 cm. x L. 1,3 m x 1 **P.U.HT 2,40 €**

## Ensemble balayette et pelle basculante

Pratique : évite de se baisser.



**43585P** L. 27 x l. 13,5 x H. 104,5 cm x 1 **P.U.HT 16,75 €**

nouveau !



## Pelle / balai

Pelle basculante Industrie avec roulettes arrières.

Pelle  
**1012559P** L. 33,5 x l. 14 x H. 105,5 cm x 1 **P.U.HT 28,25 €**

Balai  
**1012558P** L. 89 cm x 1 **P.U.HT 13,20 €**



## Pelle balayette

Pelle avec bord caoutchouc.

**1012603P** E L. 32 cm x 1 **P.U.HT 3,20 €**



## Accroche balais 3 anneaux

En aluminium. Mural.

**69108P** L. 50 x l. 8,5 x H. 9 cm x 1 **P.U.HT 38,00 €**



## Brosse inox à manche

En polypropylène blanc.

**1000772** L. 30 x l. 5 cm x 5 **P.U.HT 26,00 €**



## Brosse à main

Brosse droite polyester mi-dur

**1000769P** L. 19 cm x 1 **P.U.HT 10,40 €**



Brosse à plateau polyester dur

**1000771** L. 28 cm x 10 **P.U.HT 17,25 €**



## Brosse métal à manche

Extra dure. Manche bois 4 rangs.

**49797P** L. 30 cm x 1 **P.U.HT 3,30 €**

## GOUPILLONS

### Goupillon nylon

Pour percolateurs Ø 1,5 x L. 40 cm

**43587** x 1 **P.U.HT 1,90 €**



Pour corps de hachoir Ø 8 x 36 cm

**1000776** x 10 **P.U.HT 11,30 €**



Pour tube machine Ø 5 x 43 cm

**2611P** x 1 **P.U.HT 3,50 €**





### Presse universelle

Presse universelle avec machoires.

**1001526P** E L. 25 x l. 22,5 x H. 33 cm x 1 **P.U.HT 44,75 €**



### Seau à bec

En polypropylène avec anse. Bleu.

12 L **1001528P** Ø 26 x H. 30 cm x 1 **P.U.HT 3,10 €**



### Essoreur

**1001531P** L. 26 x l. 11 x H. 12 cm x 1 **P.U.HT 2,30 €**



### Frange coton

Monture en polyéthylène, avec douille et vis intégrée.

150 g Polycoton **66346P** L. 32 cm x 1 **P.U.HT 2,70 €**

200 g 90 % coton **66345P** L. 30 cm x 1 **P.U.HT 3,10 €**



### Frange microfibre

160 g **66349P** L. 30 cm x 1 **P.U.HT 7,70 €**

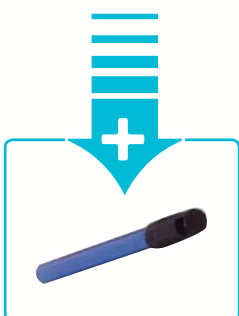

### Manche

En métal plastifié. Avec embout vis et attache.

**50071P** Ø 2,4 cm. L. 1,20 m x 1 **P.U.HT 1,40 €**



### Support lavage pro 40 cm

Base, clips de pliage et de fixation de la frange en plastique.

**66348P** E L. 40 x l. 10,7 cm x 1 **P.U.HT 24,25 €**

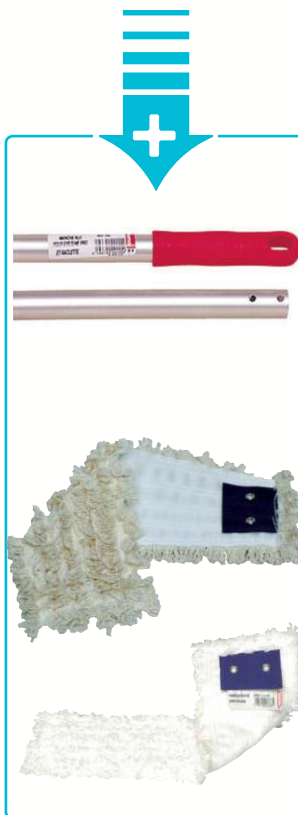

### Manche

En aluminium.

**66425P** E Ø 2,35 cm. L. 1,4 m x 1 **P.U.HT 5,00 €**

### Frange pour lavage à plat

L. 40 cm. Lavable à 40°C.

Coton **66347P** E x 1 **P.U.HT 5,70 €**

Microfibre **66426P** E x 1 **P.U.HT 9,50 €**

### Serpillère

En coton/polyester. L. 100 x 60 cm.



A

A - Extra blanc **1001532P** x 1 **P.U.HT 4,30 €**



B

B - Blanc écriu **1001548P** x 1 **P.U.HT 3,10 €**



### Panneau d'avertissement multilingue "Attention"

Efficace dans la prévention des chutes lors des opérations de nettoyage. Message imprimé sur deux faces. Anglais, français, allemand, espagnol. Pliable.

**65317P** E L. 28 x l. 4 x H. 60 cm (plié) x 1 **P.U.HT 22,50 €**

## CHARIOTS

### Chariot de ménage compact

FABRICANT  
**thomas**

- Base plastique polypropylène gris
- 4 roulettes pivotantes
- Support sac poubelle 100/130l
- Montant acier revêtu epoxy
- Support presse acier revêtu epoxy
- Presse verticale à machoire
- 2 seaux larges basse hauteur 22 l (1 rouge et 1 bleu)
- 8 accroches balai/outil
- Étagère plastique porte produits équipée de 2 seaux 5 l
- Petit porte produit
- Couvercle simple.



L. 100 x l. 72 x H. 104 cm  
**1001538P** E x 1 **P.U.HT 292,00 €**

### Chariot de ménage 2 x 18 L

En polypropylène. Pour petites et moyennes surfaces. Guidon réversible et presse universelle. 4 roues directionnelles.



L. 71 x l. 43 x H. 93 cm  
**1001540P** E x 1 **P.U.HT 111,00 €**

### Seau avec presse 20 L

En polypropylène. Seau avec presse à plat. Compact et mobile. Presse amovible. Symbole "Sol glissant" imprimé de chaque côté pour prévenir les chutes.



L. 46 x l. 26 x H. 29 cm  
**1001529P** E x 1 **P.U.HT 58,00 €**

## ASPIRATEUR ET MONOBROSSE



### Aspirateur poussière HVR200

**GARANTIE 2 ans** CE

9 L poussière

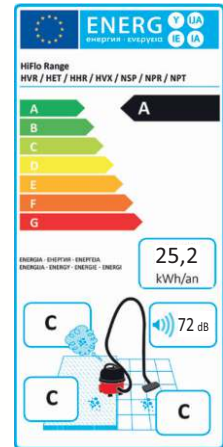

Débit d'air	32 L/s
Niveau sonore	72 dBa
Dépression	260 m/bar
Puissance	620 W
Alimentation	230 V

Caractéristique Tête et cuve en ABS. Diamètre des accessoires 32 mm. Câble 10 m.

Accessoires livrés Tubes rallonge en inox, dont 1 coudé, 5 brosses et une tête.

Dimension	34 x 34 x 37 cm
Poids	8,5 kg
Référence	<b>4170P</b>
<b>P.U.HT</b>	<b>276,00 €</b>

10 sacs filtres	<b>4174P</b>
<b>P.U.HT</b>	<b>19,50 €</b>



### Monobrosse

Son timon ergonomique facilite la prise en main des commandes. Grâce à une gamme étendue d'accessoires, la monobrosse EHF10 1015 est l'outil idéal pour de nombreuses applications, du décapage au lustrage de tous types de sols. Câble 15 m.

**GARANTIE 2 ans** CE



Puissance (W)	1000 W
Alimentation (V)	230 V
Dimensions (cm)	56 x 46 x 125 cm
Poids (kg)	26 kg
Référence	<b>1005661</b>
<b>P.U.HT</b>	<b>1 272,00 €</b>



## MAXI-ROULEAUX



### Distributeur maxi bobine



En ABS 100% recyclable.  
Distribution format par format.  
Visualisation.  
Fermeture à clé.  
Vis et clés fournies.

L. 23 x l. 24 H. 36 cm **P.U.HT**  
**64328P** x 1 **53,00 €**



### Distributeur maxi-bobine



En ABS blanc et gris. Pour bobine 450 formats à dévidage central (Ø 20,5 cm).  
Changement facile des consommables.  
Fermeture sécurisée à clé.  
4 points de fixation (kit de montage inclus).

L. 23 x l. 23 x H. 31,5 cm **P.U.HT**  
**66067P** E x 1 **26,00 €**



#### Maxi bobine bleue

Pure ouate de cellulose.  
450 formats, 2 plis.

L. 19,4 x l. 23 cm.

Paquet de 6

**1011198P**

**P.U.HT**  
x 1 **13,60 €**



#### Maxi bobine blanche

En ouate recyclée.  
450 formats, 2 plis.

L. 20 x l. 30 cm.

Paquet de 6

**67616P** E

**P.U.HT**  
x 1 **12,10 €**

nouveau !



#### Maxi bobine blanche sans mandrin

Fibre recyclée.  
450 formats, 2 plis.

L. 19,8 x l. 30 cm.

Paquet de 6

**1013681P**



**P.U.HT**  
x 1 **16,50 €**

1<sup>er</sup> PRIX



#### Maxi bobine blanche

En pure ouate, gaufrée.  
450 formats, 2 plis.

L. 18,3 x l. 22 cm.

Paquet de 6

**1008401P**

**P.U.HT**  
x 1 **11,00 €**

## MINI-ROULEAUX



#### Mini bobine blanche

En ouate recyclée. 214 formats, 2 plis.  
L. 35 x l. 21,5 cm.



Carton de 11  
**69279P**

**P.U.HT**  
x 1 **75,50 €**

#### Mini bobine gaufrée blanche

En pure ouate. 160 formats, 2 plis.  
L. 20 x l. 30 cm.



Paquet de 12  
**1002148P** E

**P.U.HT**  
x 1 **28,50 €**

#### Mini bobine blanche

Pure ouate de cellulose. 200 formats, 2 plis.  
L. 19,4 x l. 25 cm.



Paquet de 9  
**1011199P**

**P.U.HT**  
x 1 **20,25 €**

## BOBINE POUR DISTRIBUTEUR PORTABLE

### Bobine Reflex



En ouate. Le papier se découpe automatiquement à la prédécoupe et une seule main suffit pour le prendre. Contact alimentaire. 450 formats, 2 plis. L. 33,5 x l. 19,5 cm.



Paquet de 6  
**1002618P**

**P.U.HT**  
x 1 **48,75 €**







## BOBINE INDUSTRIELLE



**Bobine industrielle blanche**  
Recyclé.  
1 630 formats, 2 plis.  
L. 30,5 x l. 23 cm.

Paquet de 2  
**1011617P** E x 1 **P.U.HT**  
**28,25 €**



**Bobine industrielle blanche**  
Pure ouate de cellulose.  
1 000 formats, 2 plis.  
L. 19,4 x l. 30 cm.

Paquet de 2  
**1011200P** E x 1 **P.U.HT**  
**14,00 €**

## ESSUIE-TOUIT



### Essuie-tout en rouleau

Pure ouate de cellulose.  
64 formats, 2 plis.  
L. 23 x l. 24 cm.

Paquet de 2  
**67172P** E x 12 **P.U.HT**  
**1,90 €**



## TORCHONS JETABLES

*Premium*



### Torchon jetable



Véritable torchon de cuisine à usage unique : 1 service ou 1 journée. Non-tissé blanc et épais. Optimiser l'hygiène en cuisine. Bon isolant du froid et du chaud, absorbant et souple. Ne peluche pas. Conditionné en boîte distributrice ou en recharge. 80g/m<sup>2</sup>.

Boîte distributrice de 120 torchons  
L. 64 x l. 35 cm

**54033P** E x 1 **P.U.HT**  
**56,50 €**



Recharge de 60 torchons  
L. 64 x l. 35 cm

**58700P** x 5 **P.U.HT**  
**23,50 €**

Recharge de 100 torchons  
L. 43 x l. 38,5 cm

**54034P** E x 5 **P.U.HT**  
**22,50 €**

nouveau !



### Torchon

130 torchons pour essuyage (adapté à l'essuyage des poissons). 80 % rayonné + 20 % PET. L. 53 x l. 35 cm. Ep. 80 g/m<sup>2</sup>.

**1013684P** x 1 **P.U.HT**  
**37,00 €**

1<sup>er</sup> PRIX



### Torchon jetable

Torchon de cuisine à usage unique en non tissé, résistant et ultra performant. 75 g/m<sup>2</sup>.

Recharge de 100 torchons  
L. 50 x l. 35 cm

**1011190P** E x 5 **P.U.HT**  
**19,25 €**



## Distributeur pour essuie-mains pliés

Distributeur mural ABS 'SÉRIE 5'. Permet l'utilisation de tous les types d'essuie-mains pliés C, V, W ou M, Z. Livré avec un réducteur amovible. Fonctionne indifféremment sur les 1 pli et 2 plis.



**1007750P** E L. 29 x P. 14,5 x H. 42,5 cm  **P.U.HT 29,75 €**

## ESSUIE-MAINS PLIÉS Z



Ouate TAD soufflée pour plus de volume et de douceur un seul essuie main suffit. 150 formats, L. 25 x l. 21 cm, 2 plis. Décor laurier bleu.

**Carton de 21 60708P**  **P.U.HT 52,50 €**

nouveau !



Essuie-mains défilable. En fibre vierge. 200 formats. L. 25,5 x 21,2 cm, 2 plis.

**Carton de 25 1013682P**  **P.U.HT 2,80 €**



En ouate recyclée. Emballage hermétique. 192 formats, L. 23 x l. 23,5 cm, 2 plis.

**Paquet de 20 1011615P**  **P.U.HT 32,25 €**

1<sup>er</sup> PRIX



Pure ouate de cellulose. 150 formats, L. 21,6 x l. 23 cm, 2 plis.

**Paquet de 25 1011194P** E  **P.U.HT 28,25 €**

## ESSUIE-MAINS PLIÉS M



En ouate de cellulose. 125 formats, L. 22 x l. 35 cm, 2 plis.

**Carton de 30 59102P**  **P.U.HT 45,00 €**



Technique TAD ouate soufflée : absorbe jusqu'à 9 fois son poids ! Douceur extrême. Décor : gaufrage laurier mauve. 100 formats, L. 34 x l. 21 cm, 2 plis.

**Carton de 21 60738P**  **P.U.HT 60,50 €**

1<sup>er</sup> PRIX

Pure ouate de cellulose. 100 formats, L. 21 x l. 34 cm, 2 plis.



**Carton de 27 1011196P**  **P.U.HT 39,25 €**

## ESSUIE-MAINS PLIÉS V



En ouate recyclée. 196 formats, L. 23 x l. 20 cm, 2 plis.

**Carton de 20 1011616P**  **P.U.HT 31,25 €**



En ouate. Gaufrage lauriers, bonne absorption. 250 formats, L. 25 x l. 23 cm, 2 plis.

**Carton de 15 1000363P**  **P.U.HT 54,00 €**

## ESSUIE-MAINS ROULEAUX



En rouleaux, absorption efficace. En fibre recyclée. L. 21 cm x l. 150 m

**Carton de 6 1013680P**  **P.U.HT 45,50 €**

1<sup>er</sup> PRIX



Pure ouate de cellulose. L. 19,4 cm x l. 110 m.

**Carton de 6 1011195P**  **P.U.HT 19,75 €**





## Distributeur pour recharge savon liquide



En ABS blanc 100% recyclable. Contenance 1 L. Livré avec kit de fixation. Fermeture à clé. Distribution 1 ml/pression soit 1000 doses.

1 L  
**64329** L. 11 x l. 11 x H. 29 cm x 1 **P.U.HT 40,25 €**



**Savon mousse doux**  
Formule douce, agréablement parfumée.



Carton de 6  
**A 69715P** 1 L = 2500 doses x 1 **P.U.HT 88,50 €**

**Savon liquide extra hygiénique**



Carton de 6  
**B 60689P** 1 L = 1000 doses x 1 **P.U.HT 70,50 €**

**Savon liquide doux**



Carton de 6  
**C 60688P** 1 L = 1000 doses x 1 **P.U.HT 59,00 €**

**Recharge savon spray**  
Savon le plus économique du marché. Testé dermatologiquement, non parfumé. Cartouche évitant la contamination croisée.



Carton de 6  
**D 1007735** 1 L = 3000 doses x 6 **P.U.HT 14,20 €**

**Recharge savon doux corps et cheveux**



Carton de 8  
**E 65716P** x 1 **P.U.HT 76,00 €**



## Distributeur savon gel



En ABS. Indicateur de niveau. Réservoir amovible. Fermeture à clé.

800 ml  
**66009P** E L. 11,5 x l. 21,3 x H. 11,7 cm x 1 **P.U.HT 23,00 €**



## Lotion lavante bactéricide\*\*



Respecte tous les types de peaux, même les plus sensibles grâce à son pH cutané. Parfum fruité sans substance allergisante. Conforme norme in-vivo EN1499.

Non disponible en Suisse

**69354\*** E Bidon de 5 L x 2 **P.U.HT 16,25 €**

\*Dangereux. Respecter les précautions d'emploi. Produit conforme à la législation française.

\*\*Utilisez les biocides avec précaution. Avant toute utilisation, lisez l'étiquette et les informations concernant le produit.

## Crème lavante mains

Nettoie efficacement en douceur grâce aux agents nettoyants d'origine végétale.

**1008373P** E Bidon de 5 L x 1 **P.U.HT 6,20 €**

## SÈCHE-MAINS



### Sèche-mains V7



Sèche-mains nouvelle génération. Séchage rapide par 300 microbusés, sans mouvement des mains. Carrosserie en ABS très résistante et traitée Microban® (anti-bactérien) dans la masse. Bac récupérateur d'eau avec évaporateur d'eau intégré garantissant un nombre important de séchages sans vidange du bac. Filtrés HEPA filtrant 99,9% des bactéries et allergènes de la pièce, désodorisant zeromell en option pour rafraîchir l'air des sanitaires. Livré avec kit de pose complet. Débit d'air : 432 m<sup>3</sup>/h - 1760W - 230 V. L. 30 x P. 19,5 x H. 61,7 cm.

**1006225** Blanc x 1 **P.U.HT 719,00 €**

**1006226** Noir x 1 **P.U.HT 813,00 €**

Autres coloris nous consulter



**1006227** Gris aluminium x 1 **P.U.HT 813,00 €**



### Sèche-mains



Temps de séchage : 10 à 15 secondes. Vitesse d'air : 450 km/h. Isolation électrique classe II. IP24. Niveau sonore : 76 dBA. Protection anti-vandalisme IK10 : capot en aluminium. Effet lumineux dans la zone de séchage. Option : emplacement disponible pour 1 filtre antibactérien. 1200 W - 230 V.

L. 23,2 x l. 19,4 x H. 28,5 cm  
**1011094** Gris métal x 1 **P.U.HT 251,00 €**  
**1011093** Blanc x 1 **P.U.HT 245,00 €**

### Sèche-mains Ouragan



En acier époxy. Buse de sortie orientable. Débit d'air : 270 m<sup>3</sup>/h. Niveau sonore 85 dBA. 2500 W - 230 V. Fréquence 50-60 Hz. Classe I - IP 21.

**1004329P** L. 26,5 x l. 20 x H. 24 cm x 1 **P.U.HT 219,00 €**



### 1<sup>er</sup> PRIX

### Sèche-mains Austral



Déclenchement automatique à l'approche des mains. Capot polycarbonate antivandalisme. Conforme 73/23/CEE et 89/336/CEE. Arrêt automatique en cas de dysfonctionnement. Niveau sonore : 62 dBA. Débit d'air : 250 m<sup>3</sup>/h. 2300 W. 230 V. Classe II - IP 23.

**49203P** E L. 21,3 x l. 20,4 x H. 24,4 cm x 1 **P.U.HT 161,00 €**





### Distributeur universel pour papier en rouleaux

En ABS. Pour 2 rouleaux traditionnels.

Blanc  
**1007709** L. 29,3 x H. 16,7 x P. 16,6 cm x 1 **P.U.HT 49,25 €**



En inox époxy. Distributeur pour rouleau de papier hygiénique standard. Kit de montage au mur inclus.

Blanc  
**66164** L. 13,2 x l. 13 x H. 10,4 cm x 1 **P.U.HT 13,80 €**



### Papier hygiénique en rouleaux

Papier hygiénique compact



Rouleau compact 2 plis sans mandrin. 500 formats.

Paquet de 6  
**100736P** x 8 **P.U.HT 8,60 €**



Papier hygiénique



Quate douce extra blanche. 153 formats, 2 plis. Gaufrage fleur.

Carton de 9 x 12 rouleaux  
**1007003P** Blanc x 1 **P.U.HT 28,50 €**



Papier hygiénique



Quate extra douce extra blanche. 186 formats, 2 plis. Gaufrage fleur.

Carton de 9 x 12 rouleaux  
**1007004P** Blanc x 1 **P.U.HT 35,75 €**



Papier hygiénique extra doux



Quate de cellulose. 153 formats, 4 plis.

Paquet de 6 rouleaux  
**64377P** Blanc x 7 **P.U.HT 4,70 €**



Papier recyclé



Quate gaufrée. 200 formats, 2 plis.

Carton de 9 x 12 rouleaux  
**1001392P** Blanc x 1 **P.U.HT 26,00 €**

1<sup>er</sup> PRIX

### Papier hygiénique

Quate. 300 formats, 2 plis.



Paquet de 6  
**1011614P** x 16 **P.U.HT 3,00 €**

### DISTRIBUTEUR PAPIER À PLAT



### Distributeur papier feuille



En ABS blanc 100% recyclable. Distribution feuille à feuille. Contenance 2 paquets de 250 feuilles. Fenêtre de visualisation. Vis et chevilles fournies.

**64326** E L. 13 x l. 13 x H. 27 cm x 1 **P.U.HT 34,00 €**



### Papier hygiénique en feuilles



Recharge papier hygiénique feuille à feuille Pure ouate de cellulose. 2 plis, 252 formats. L. 19 x l. 11 cm.



Extra doux Colis de 30  
**1005022P** Blanc x 1 **P.U.HT 70,50 €**



Doux Colis de 30  
**1005023P** Blanc x 1 **P.U.HT 50,50 €**

1<sup>er</sup> PRIX



Pure ouate de cellulose. 250 formats enchevêtrés. L. 19 x l. 11 cm, 2 plis.

Paquet de 36  
**1011191P** E Blanc x 1 **P.U.HT 27,25 €**



## MAXI JUMBO

## MINI JUMBO



### Distributeur **ROSSIGNOL**

En acier poudré époxy. Dimension du mandrin : 5 cm. Contrôle du niveau du consommable. Antivol et antivandalisme. Pour Maxi Bobines jusqu'à 400 m.

✓ **66162P** E L. 29 x l. 11,8 x H. 29 cm x 1 **P.U.HT**  
**29,00 €**



### Maxi Jumbo **TORK**

Ouate de cellulose 2 plis blanche. 1800 formats, 360 m. Décor feuille.

✓ **Colis de 6**  
**49066P** Blanc x 1 **P.U.HT**  
**18,25 €**



En pure ouate de cellulose, 2 plis. 1117 formats, 380 m.

✓ **Carton de 6**  
**1011193P** Blanc x 1 **P.U.HT**  
**17,25 €**

**1<sup>er</sup> PRIX**



En ouate fibre recyclée, 2 plis. 1086 formats, 380 m.

✓ **Paquet de 6**  
**1011653P** E Blanc x 1 **P.U.HT**  
**15,50 €**



### Distributeur mini jumbo **TORK**

Distributeur en ABS blanc 100 % recyclable. Système anti-rupture. Fenêtre de visualisation. Compartiment pour les fins de rouleaux. Economies assurées. Fermeture à clé. Vis et chevilles fournies.

✓ **64325** E L. 34,5 x l. 13,2 x H. 27,5 cm x 1 **P.U.HT**  
**45,25 €**



### Mini jumbo **TORK**

En ouate de cellulose, 2 plis. Décor feuille. 850 formats. 170 m.

✓ **Colis de 12**  
**49065P** Blanc x 1 **P.U.HT**  
**24,50 €**



En pure ouate de cellulose, 2 plis. 529 formats, 180 m.

✓ **Carton de 12**  
**1011192P** Blanc x 1 **P.U.HT**  
**21,25 €**

**1<sup>er</sup> PRIX**



En ouate, 2 plis. 850 formats, 170 m.

✓ **Paquet de 12**  
**1011652P** E Blanc x 1 **P.U.HT**  
**16,75 €**

## SMARTONE



### Smartone **TORK** SmartOne

Distributeur de papier toilette feuille à feuille pour une réduction de consommation. Associe un rouleau de forte autonomie à un système de distribution performant et hygiénique (rouleau entièrement protégé).

✓ **Distributeur simple T8**  
**1011654** E L. 26,7 x l. 15,5 x H. 26,9 cm x 1 **P.U.HT**  
**26,75 €**



✓ **Distributeur double T9**  
**1011655** L. 21,85 x l. 15,6 x H. 21,8 cm x 1 **P.U.HT**  
**33,00 €**



**Papier hygiénique rouleau T8**  
En ouate 2 plis. 1150 formats.

✓ **Paquet de 6**  
**1002620P** E Blanc x 1 **P.U.HT**  
**35,50 €**



**Papier hygiénique rouleau T9**  
En ouate de cellulose recyclée. 620 formats, 2 plis.

✓ **Paquet de 12**  
**1007737P** Blanc x 1 **P.U.HT**  
**40,75 €**



## ARMOIRES D'ENTRETIEN

Livré monté



### Vestiaire monobloc

Structure métallique. Fermeture par loqueteau ou en option : morailon, serrure à clé, serrure à code. Dispositif pour distribution de courrier. Option : pieds amovibles tôle ou inox. Accessoires : coiffe et socle banc. Tablette porte-chapeau et tige porte-cintre. Conforme à la réglementation en vigueur (norme NF D65-760). Coloris : gris/bleu.

**Armoire 1 cloison** **P.U.HT**  
**59115** E L. 31 x P. 50 x H. 180 cm x 1 **215,00 €**

Dont Éco-participation 0,41€

**Armoire 2 cloisons** **P.U.HT**  
**59116** E L. 59 x P. 50 x H. 180 cm x 1 **318,00 €**

Dont Éco-participation 0,61€

**Armoire 3 cloisons** **P.U.HT**  
**59117** E L. 87 x P. 50 x H. 180 cm x 1 **450,00 €**

Dont Éco-participation 1,24€

**Armoire 4 cloisons** **P.U.HT**  
**59117** E L. 118,5 x P. 50 x H. 180 cm x 1 **607,00 €**

Dont Éco-participation 1,46€



61501

### Armoire entretien

**TOURNUS  
EQUIPEMENT**

Construction soudée en acier inoxydable, hauteur bord avant 180 cm/arrière 189 cm. Port(e)s doublé(s) avec fermeture à clé. Toit incliné pour faciliter le nettoyage. Armoire avec séparation verticale : 3 demi-étagères réglables + 1 inférieure fixe. Piètement Ø 60 mm avec vérins à filetage non apparent permettant un réglage de 50 mm.

**Armoire 1 porte** **P.U.HT**  
**61501** E L. 60 x l. 50 x H. 180 cm x 1 **1 257,00 €**

Dont Éco-participation 1,27€

**Armoire 2 portes** **P.U.HT**  
**61502** E L. 100 x l. 50 x H. 190 cm x 1 **1 908,00 €**

Dont Éco-participation 1,83€

## ARMOIRE À PHARMACIE



### Armoire à pharmacie **ROSSIGNOL**

**GARANTIE  
2  
ans**

En acier peint époxy. Serrure à clé. 2 étagères plastique réglables en hauteur. 1 balconnet de rangement en plastique.

**Armoire 1 porte** **P.U.HT**  
**1004683P** E L. 30 x l. 13 x H. 45,5 cm x 1 **51,00 €**

### Kit équipement pour armoire à pharmacie **ROSSIGNOL**

- Comprend :
- 1 pansement compressif 10 x 10 cm,
  - 1 bande extensible maille élastique 5 cm x 3 m,
  - 4 lingettes asséchantes (équivalent à de l'éosine),
  - 4 lingettes apaisantes au calendula,
  - 1 sparadrap tissu blanc 2,5 cm x 5 m,
  - 1 paire de gants,
  - 18 pansements Urgo 3 tailles
  - 10 compresses stériles 20 x 20 cm.

**Le kit** **P.U.HT**  
**60798P** E x 1 **24,00 €**

## DÉSINSECTISEURS

### Désinsectiseur



**GARANTIE  
5  
ans**



FLY in Box 20 inox	
Puissance	1 x 20 W
Alimentation	220 V
Dimensions	L. 26,5 x l. 12,5 x H. 26 cm
Poids	3 kg
Surface de protection	50 m <sup>2</sup>
Référence	<b>1010596P</b> €
<b>P.U.HT</b>	<b>77,50 €</b>

FLY in Box 40 inox	
Puissance	2 x 20 W
Alimentation	220 V
Dimensions	L. 33 x l. 12,5 x H. 26 cm
Poids	3,6 kg
Surface de protection	120 m <sup>2</sup>
Référence	<b>1010597P</b> €
<b>P.U.HT</b>	<b>94,50 €</b>

Lampe à UV pour FLY in Box et Iglu

**P.U.HT**  
**1010598** E 20 W x 1 **18,25 €**

Capture 800 inox	
Puissance	2 x 36 W
Alimentation	220 V
Dimensions	L. 63,5 x l. 11 x H. 26 cm
Poids	6,9 kg
Surface de protection	240 m <sup>2</sup>
Référence	<b>1010599</b> €
<b>P.U.HT</b>	<b>196,00 €</b>

Tube néon 61 cm pour Capture 800  
T08 Europe

**P.U.HT**  
**1010600** E 36 W x 1 **6,60 €**

Iglu acier noir	
Puissance	20 W
Alimentation	230 V
Dimensions	L. 20 x l. 7,5 x H. 30 cm
Poids	1,2 kg
Surface de protection	50 m <sup>2</sup>
Référence	<b>1010594</b>
<b>P.U.HT</b>	<b>48,75 €</b>

Paquet de 6 plaques de glue  
pour désinsectiseur IGLU.

**P.U.HT**  
**1010595P** x 1 **7,60 €**

Tubes 2 x 15 W et 2 x 40 W  
disponibles sur commande, nous consulter.

### Insecticide pour volants / rampants\*\*

Usage professionnel. Insecticide curatif recommandé contre : mouches, guêpes, mites, moustiques, acariens, cafards, puces, poux, tiques, araignées, blattes...

**Aérosol de 500 ml** **P.U.HT**  
**1001620P\*\*** x 1 **16,75 €**

\* Dangereux. Respecter les précautions d'emploi.  
Produit conforme à la législation française.  
\*\* Utilisez les biocides avec précaution. Avant toute utilisation, lisez l'étiquette et les informations concernant le produit.

### Anti-insectes

Contre les insectes volants et rampants, pour intérieur. Formulé à base de géranol, répulsif naturel. Effet barrière immédiat et durable (jusqu'à 4 semaines). Efficace contre les mites, acariens et punaises de lits.

**Spray de 750 ml** **P.U.HT**  
**1011634P** x 6 **9,90 €**

Produit  
non classé



3 L



## Poubelle à pédale

probbax

En métal époxy.  
Collecteur à pédale avec bac intérieur amovible.  
Mécanisme de la pédale en métal pour une meilleure durée de vie.  
Ergots anti-glisse à la base pour un bon maintien en place.  
Facile à entretenir.

Ø 16,7 x H. 27 cm  **P.U.HT**  
**62047P** 3 L x1 **16,25 €**

5 L



Ø 20,3 x H. 28,4 cm  **P.U.HT**  
**62048** 5 L x4 **23,75 €**

12 L



Ø 28,4 x H. 40 cm  **P.U.HT**  
**1008154** 12 L x1 **34,00 €**

20 L



Ø 29,2 x H. 44,5 cm  **P.U.HT**  
**1008166** 20 L x1 **49,25 €**

30 L



Ø 29,2 x H. 64 cm  **P.U.HT**  
**1008155** 30 L x1 **74,00 €**

3 L



## Poubelle à pédale

Bathbazaar

Design exclusif Bathbazaar. En inox finition époxy noir mat. Système d'ouverture à pédale très résistant. Seau en plastique amovible.

Ø 18,5 x H. 26 cm  **P.U.HT**  
**1011113** 3 L x1 **38,25 €**

3 L



## Poubelle à pédale inox

Bathbazaar

Seau amovible. La base large procure une très grande stabilité. Pédale renforcée. Système de fermeture silencieux. En acier inoxydable traitement anti-tâches.

Ø 22 x H. 29 cm  **P.U.HT**  
**66733P** 3 L x1 **31,50 €**

4 L



## Poubelle à pédale plastique

Plastique blanc.

L. 22,5 x l. 20 x H. 23,5 cm  **P.U.HT**  
**4599P** E 4 L x1 **11,60 €**





Sacs 50 L

### Poubelle à papier Basic ROSSIGNOL

Avec trappe 18 x 15 cm.  
Ø 31 x H. 77,5 cm.

45 L  
**58462** Inox x 1 **P.U.HT 208,00 €**  
**58457** Acier époxy noir x 1 **147,00 €**



Sacs 50 L

### Poubelle snacking probbax

En époxy gris argenté. Composé d'un couvercle dôme, d'un bac intérieur et du corps. Ouverture à trappe. Bac intérieur galvanisé amovible avec poignée.

40 L  
**1007384** Ø 35 x H. 74 cm x 1 **P.U.HT 121,00 €**



Sacs 110 L

### Poubelle snacking TOURNUS EQUIPEMENT

En acier inoxydable. Façade inox mobile comportant à l'arrière un socle et un méplat très rigide d'épaisseur 4 mm pour le support du sac. Dessus avec rebord pour la dépose des plateaux. Volet battant pour les déchets.

110 L  
**1007363** L. 44,4 x l. 48 x H. 123,6 cm x 1 **P.U.HT 981,00 €**



Sacs 110 L

### Pince-sac probbax INOX 18/10 A.C.C.P.

En inox à pédale. Ouverture en portefeuille avec bande de maintien du sac. Roulettes caoutchouc avec freins. Plateforme de rétention des liquides. Arceaux latéraux.

**1010799** L. 59 x l. 43 x H. 100 cm x 1 **P.U.HT 232,00 €**

Sacs 110 L à 130 L



### Pince-sac A.C.C.P.

En inox et caoutchouc.

**70123P** L. 55 x l. 42,5 x H. 94 cm x 1 **P.U.HT 170,00 €**

nouveau !



### Meuble poubelle Jacky

Structure en panneau mélaminé 18 mm. Chants PVC. Trappe avant basculant en inox. 4 roulettes dont 2 avec frein. Poubelle non comprise. Coloris wengé.

Meuble poubelle 80 L  
**1013467** L. 54 x l. 42 x H. 136 cm x 1 **P.U.HT 354,00 €**



Sacs 110 L

### Collecteur probbax A.C.C.P.

En polypropylène.

80 L  
**1005382** E L. 46 x l. 32 x H. 76,2 cm x 1 **P.U.HT 43,75 €**

### Collecteur Collec'roule ROSSIGNOL

En acier poudré époxy ou inox. Ceinture pour maintien du sac et satchet de fixation. Avec pédale. Roues Ø 15 cm. Couvercle Ø 41 cm. Livré démonté.

Sacs 110 L

L. 57 x l. 52 x H. 91 cm. **P.U.HT**  
**42273** E Gris x 1 **138,00 €**  
**49223** E Inox x 1 **212,00 €**





Sacs 110 L



## Support sac poubelle tri sélectif



En polypropylène. Structure renforcée par une barre aluminium. Polyvalent et simple à déplacer, adapté au tri sélectif pour une application écologique. Livré démonté.

120 L - Avec couvercle - L. 50 x l. 64 x H. 99 cm		📦	P.U.HT
1007085	E Blanc	x 1	148,00 €
1007088	E Vert	x 1	148,00 €
1007084	E Bleu	x 1	148,00 €
1007086	E Jaune	x 1	148,00 €
1007087	E Rouge	x 1	148,00 €

HACCP : tri sélectif grâce aux couvercles de couleur.  
 Encombrement : réduit grâce aux pédales incrustées dans le conteneur.  
 Hygiénique : les angles arrondis permettent un nettoyage facile.  
 Le système de couvercle recouvrant lutte contre la diffusion d'odeurs.  
 Solide.



Sacs 50 L



Sacs 100 L



## Collecteur à pédale tri sélectif



En polypropylène. L'ouverture à pédale libère les mains pour une utilisation aisée et hygiénique. Construction robuste avec anneau de renfort en métal à l'avant pour une stabilité garantie et roulettes (sur modèle 90 L). Livrés avec 6 autocollants de tri sélectif.

A - 45 L - Avec couvercle - L. 41 x l. 39,8 x H. 60 cm		📦	P.U.HT
65316P	E Blanc	x 1	73,00 €
1005387	E Vert	x 1	73,00 €
1005484	E Bleu	x 1	73,00 €
1005385	E Jaune	x 1	73,00 €
1005386	E Rouge	x 1	73,00 €

B - 90 L - Avec couvercle - L. 50 x l. 41,2 x H. 82 cm		📦	P.U.HT
65025P	E Blanc	x 1	125,00 €
1005391	E Vert	x 1	125,00 €
1005388	E Bleu	x 1	125,00 €
1005389	E Jaune	x 1	125,00 €
1005390	E Rouge	x 1	125,00 €

1<sup>er</sup> PRIX

Sacs 110 L à 130 L



## Collecteur à pédale Boogy tri sélectif



Construction polyéthylène, robuste et durable, utilisable en extérieur, facile d'entretien. Vendu avec couvercle.

90 L - Avec couvercle - L. 51 x l. 51 x H. 89,5 cm		📦	P.U.HT
1005007	Blanc	x 1	103,00 €
1005010	Vert	x 1	103,00 €
1005009	Bleu	x 1	103,00 €
1005008	Jaune	x 1	103,00 €
1005011	Rouge	x 1	103,00 €



Ouverture avant :  
facilite le retrait du sac



Clipsage assurant  
un bon verrouillage



Nettoyage au jet



Sacs 110 L à 130 L



## Collecteur à déchets Skippy



Construction en polyéthylène. Pratique : façade avant amovible pour dégagement rapide et sans effort du sac plastique intérieur. Serre-sac et pédale. Livré monté.  
Autres coloris pour le tri sélectif : nous consulter.

Collecteur gris / bleu

<b>39295P</b>	130 L - L. 52 x l. 51 x H. 110 cm
<b>42091</b>	110 L - L. 52 x l. 51 x H. 75 cm



x 1  
x 1

P.U.HT

**564,00 €**  
**557,00 €**



## Collecteur



En polypropylène, robuste et durable. Simple à nettoyer et à entretenir.  
Chaque couvercle est livré avec 6 autocollants de tri.  
Couvercles et attache chariot compatibles avec les 2 tailles de collecteurs.

Sacs 110 L

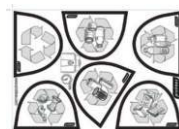

Autocollants de tri

Collecteur gris

<b>A 1005382</b>	E 80 L - L. 46 x l. 32 x H. 76,2 cm
<b>B 1005383</b>	E 60 L - L. 46 x l. 32 x H. 58 cm



x 1  
x 1

P.U.HT

**43,75 €**  
**32,25 €**

Chariot avec roulettes pivotantes

<b>C 1005384</b>	E L. 48 x l. 33 x H. 14,5 cm - Noir
------------------	-------------------------------------



x 1

P.U.HT

**49,00 €**

Couvercle

<b>D 1005392</b>	E Vert - Pour bouteilles L. 45,3 x l. 32,8 cm	x 1	<b>17,25 €</b>
<b>E 1005394</b>	E Jaune - Pour cartons et plastiques L. 45,3 x l. 32,8 cm	x 1	<b>19,50 €</b>
<b>F 1013427</b>	Bleu - Pour bouteilles L. 45,5 x l. 32,8 cm	x 1	<b>16,75 €</b>
<b>G 1005393</b>	E Gris Push - Pour déchets divers L. 47 x l. 33,5 cm	x 1	<b>12,70 €</b>
<b>H 1010797</b>	Gris Basculant - Pour déchets divers L. 45,5 x l. 33,3 x H. 17,5 cm	x 1	<b>23,00 €</b>



x 1

P.U.HT

**17,25 €**

**19,50 €**

**16,75 €**

**12,70 €**

**23,00 €**

Attache murale pour collecteur basculant

<b>I 1010798</b>	E Acier noir - L. 41 x l. 13,5 cm
------------------	-----------------------------------



x 1

P.U.HT

**20,25 €**



## Conteneur extérieur

ROSSIGNOL

En polyéthylène haute densité. Robuste, résistant aux UV, aux produits chimiques et aux différentes conditions climatiques. Conforme à la norme EN-840. Couvercle amortisseur de bruit. Poignées intégrées sur le corps et le couvercle (manipulation aisée). 2 roues freins permettant de stabiliser le produit. Bonde de vidage pour faciliter le nettoyage.



Sacs 240 L



240 L  
55097 E L. 75 x l. 57 x H. 107 cm x 1 P.U.HT 107,00 €

## Poubelle d'immeuble

En polypropylène.



Sacs 100 L



Corps seul 80 L  
49591P Ø 55 x H. 48 cm x 1 P.U.HT 12,50 €

Couvercle seul  
49592P x 1 P.U.HT 5,80 €

## Housse pour container

ROSSIGNOL

Housses grand volume 750L. Très résistantes, idéales pour les professionnels. Epaisseur 26 µ. Noir.



Carton de 100  
1008682P L. 195 x H. 150 cm x 1 P.U.HT 60,00 €

## Sac poubelle



Contenance	5 L	10 L	20 L	30 L
Descriptif	Sac à déchets idéal en milieu hospitalier.			
Coloris	Blanc	Blanc	Blanc	Blanc
Largeur	33,5 cm	40 cm	45 cm	50 cm
Hauteur	35 cm	45 cm	48 cm	65 cm
Conditionnement	1000	1000	1000	1000
Epaisseur	10 µ	10 µ	10 µ	11 µ
Référence	1008686P	1008687P	1008688P	1008689P
P.U.H.T	13,10 €	20,25 €	32,25 €	42,25 €



Contenance	5 L	110 L	130 L
Descriptif	Idéal pour les professionnels.		
Coloris	Transparent	Transparent	Transparent
Largeur	30 cm	70 cm	80 cm
Hauteur	45 cm	105 cm	115 cm
Conditionnement	1000	200	200
Epaisseur	22 µ	43 µ	45 µ
Référence	1013100P	1008707P E	1008708P
P.U.H.T	7,00 €	42,25 €	53,50 €



Contenance	30 L	50 L	100 L	100 L	100 L	110 L	110 L	110 L	130 L	130 L
Descriptif	Sacs résistants. Idéal pour le milieu de l'hôtellerie - restauration.									
Coloris	Noir	Noir	Noir	Noir	Noir	Noir	Noir	Noir	Noir	Noir
Largeur	50 cm	68 cm	82 cm	82 cm	82 cm	70 cm	70 cm	70 cm	80 cm	80 cm
Hauteur	65 cm	75 cm	85 cm	85 cm	85 cm	105 cm	105 cm	105 cm	115 cm	115 cm
Conditionnement	1000	250	200	200	200	200	200	100	100	100
Epaisseur	11 µ	35 µ	42 µ	49 µ	59 µ	42 µ	49 µ	59 µ	33 µ	40 µ
Référence	1008690P	1008691P	1008692P	1008693P	1008694P	1008695P	1008696P E	1008697P	1008698P	1008699P
P.U.H.T	49,50 €	27,75 €	29,25 €	38,25 €	47,25 €	30,25 €	40,25 €	22,25 €	18,25 €	17,75 €

Contenance	130 L	130 L	130 L	150 L	160 L	170 L	240 L	240 L	330 L
Descriptif	Sacs résistants. Idéal pour le milieu de l'hôtellerie - restauration.								
Coloris	Noir	Noir	Noir	Noir	Noir	Noir	Noir	Noir	Noir
Largeur	80 cm	80 cm	80 cm	82 cm	90 cm	93 cm	115 cm	114 cm	138 cm
Hauteur	115 cm	115 cm	115 cm	130 cm	110 cm	118 cm	135 cm	135 cm	140 cm
Conditionnement	100	100	70	100	100	100	200	50	100
Epaisseur	50 µ	55 µ	97 µ	63 µ	49 µ	49 µ	20 µ	70 µ	20 µ
Référence	1008700P E	1008701P	1008702P	1008703P	1008704P	1011618P	1008705P E	1008683P	1008706P
P.U.H.T	24,25 €	28,25 €	40,25 €	37,25 €	30,75 €	31,25 €	64,00 €	28,75 €	40,25 €





### Calot non-tissé

En viscose non tissé. 40 g/m<sup>2</sup>.  
L. 28 x H. 8,2 cm

Carton de 200  
**1000368P** E

x 1 **P.U.HT**  
**16,25 €**



### Calot papier blanc

En papier. L. 28 x H. 8,2 cm  
Réglable.

Carton de 100  
**1000365P** E

x 1 **P.U.HT**  
**7,00 €**



### Calot papier liseré bleu

En papier. L. 28 x H. 8,2 cm

Carton de 100  
**1000366P** E

x 1 **P.U.HT**  
**7,00 €**



### Distributeur de calots

Mural. En inox.  
L. 31 x P. 10,5 x H. 12 cm

**49373** E

x 1 **P.U.HT**  
**57,50 €**



### Casquette résille

100% polypropylène non tissée.  
Cette casquette résille est idéale  
pour les grandes chevelures.  
Taille unique.

Boîte de 100  
**64690P** E

x 1 **P.U.HT**  
**9,80 €**



### Toque Mélusine

En viscose non tissé. Ø 65 x H. 25 cm.

Carton de 10  
**1000369P**

x 1 **P.U.HT**  
**25,50 €**



### Toque Shadow

En viscose non tissé. Ø 66 x H. 21 cm.

**Blanc**

Carton de 10  
**1000370P** E

x 1 **P.U.HT**  
**9,00 €**

**Noir**

Carton de 10  
**1000371P**

x 1 **P.U.HT**  
**11,80 €**



### Charlottes à clip

En non-tissé. Élastique synthétique  
SANS LATEX sous ourlet.

Carton de 300  
**1007765P** E

x 1 **P.U.HT**  
**8,70 €**



### Charlotte

Ø 53 cm.

Carton de 100  
**1000367P**

x 1 **P.U.HT**  
**4,50 €**



### Masque papier

Masque papier 1 pli (1 couche) très léger  
et économique. Taille unique.

Boîte de 100  
**64699P** E

x 1 **P.U.HT**  
**1,80 €**



### Distributeur de masques

Mural. En inox.

L. 8,7 x P. 4,7 x H. 26 cm  
**49371** E

x 1 **P.U.HT**  
**29,75 €**



### Surlunette de protection



En polycarbonate incolore. Monture  
monobloc, protection latérale et frontale  
moulée. Assure une excellente couverture,  
bonne protection panoramique. Légère et  
confortable, elle se porte par-dessus tous  
les types de lunettes de vue. Monture  
idéale pour une protection de manière  
occasionnelle.

L. 30 x P. 13 x H. 5,9 cm  
**69335P** E Incolore

x 20 **P.U.HT**  
**3,10 €**

nouveau !



### Kit four

Kit de protection pour opérateurs lors du  
nettoyage des fours (1 paire de lunettes  
masque + 1 demi masque réutilisable + 2  
cartouches A2P3 + notice utilisation).

Kit four  
**1013579**

x 1 **P.U.HT**  
**64,50 €**



## Tablier

En polyéthylène. Blanc. Ep. 12 µ.  
L. 70 x H. 120 cm.

Carton de 100  
**1000372P** E

x 1 **P.U.HT**  
**8,10 €**



## Blouse

En polypropylène. Une poche poitrine,  
une poche basse. Agréable, respirante et  
légère. 40 g. L. 75 x H. 105 cm.

Carton de 50  
**1004693P** E

x 1 **P.U.HT**  
**54,50 €**



## Surchaussure

En polyéthylène bleu. Ep. 40µ.  
Surchaussure visiteurs PE 3,5 g.  
Elastique de maintien à la cheville.  
Taille unique.

Carton de 100 (50 paires)  
**64698P** E

x 1 **P.U.HT**  
**3,00 €**



## Kit visiteurs

Kit visiteurs composé de : surchaussures  
en CPE bleu, charlotte ronde Ø 48 cm,  
masque papier 1 pli, blouse visiteur en  
PE transparent avec capuche et boutons  
pressions.

Carton de 100  
**63609P** E

x 1 **P.U.HT**  
**54,50 €**

## Distributeur kit visiteurs

Mural. En inox. Qualité alimentaire.  
L. 10,5 x P. 12,3 x H. 43,5 cm

**49374** E

x 1 **P.U.HT**  
**51,50 €**

## Gant gros travaux

Souple et néanmoins résistant, ce gant  
permet aux utilisateurs de manipuler des  
liquides froids ou chaud sans contraintes.  
En latex naturel, intérieur jersey 100%  
coton. L. 31 cm.

**64695P** E Taille 7 x 1 **5,60 €**  
**64696P** E Taille 8 x 1 **5,60 €**  
**64796P** E Taille 9 x 1 **5,60 €**

## Gant de ménage

Gant étanche en latex de couleur. Revête-  
ment intérieur en latex naturel blanc avec  
flocage coton. Surface antidérapante sur  
la paume et les doigts. Léger et résistant,  
ce produit est idéal pour les travaux  
ménagers courts où les mains peuvent  
être mises à rude épreuve.  
L. 32 cm. Ep. 40 µ.

**64700P** E Taille 7 x 1 **0,80 €**  
**64701P** E Taille 8 x 1 **0,80 €**

nouveau !



## Gant de plongee noir

En PVC noir floqué, avec manchette translucide  
40 cm. Normes EN 374 - EN 388 - EN 420.

Paquet de 2  
**1013583P** Taille L

x 1 **P.U.HT**  
**11,20 €**

nouveau !



## Gant nitrile noir

Non poudré.

Boîte de 100

**1013580P** Taille M x 1 **7,30 €**  
**1013581P** Taille L x 1 **7,30 €**  
**1013582P** Taille XL x 1 **7,30 €**



## Gant nitrile bleu

Normé EN 455 - 1/2 (DM). Offre une excellente  
résistance mécanique et chimique. Ambidextre.  
Gant texturé facilitant les manipulations dans les  
environnements secs et humides. Ne contient pas de  
latex et non poudré pour éviter tout risques d'allergies.  
Agréé contact alimentaire pour l'ensemble des aliments.  
Bord roulé : améliore la résistance à la déchirure et  
permet au gant de ne pas rouler le long du poignet.

Boîte de 200

**1007778P** E Taille M x 1 **10,00 €**  
**1007779P** E Taille L x 1 **10,00 €**  
**1007780P** E Taille XL x 1 **10,00 €**



## Gant nitrile blanc

Normé EN 374 - 1/2 (EPI) / EN 455 - 1/2 (DM). Agréé  
contact alimentaire pour tous types d'aliments.  
Ambidextre. Offre une excellente résistance mécanique  
et chimique. Hypoallergénique. Gant texturé facilitant les  
manipulations dans les environnements secs et humides.  
Sans poudre.

Boîte de 100

**1005108P** Taille M x 1 **5,50 €**  
**1005109P** Taille L x 1 **5,50 €**  
**1005110P** Taille XL x 1 **5,50 €**



## Gant latex SafeTouch Connect

Normé EN 374 - 1/2 (EPI) / EN 455 - 1/2 (DM).  
Agréé contact alimentaire pour les produits acqueux  
uniquement. Grande élasticité. Bonne dextérité. Poudré,  
sa mise en oeuvre est facilitée. Contre-indications :  
le latex est une matière naturelle qui contient des  
protéines. Risques d'allergies possibles.

Paquet de 100 - Naturel

**1007771P** E Taille S x 1 **4,90 €**  
**1007784P** E Taille M x 1 **4,90 €**  
**1007785P** E Taille L x 1 **4,90 €**  
**1007786P** E Taille XL x 1 **4,90 €**



## Gant vinyle SafeTouch EverStrong

Normé AQL 1.5 - E 374 - 1/2 (EPI) / EN 455 - 1/2 (DM).  
Ambidextre. Poudré. Recommandé aux personnes  
allergiques au latex. Agréé contact alimentaire pour les  
produits acqueux uniquement.

Boîte de 100

**64688P** E Taille S x 1 **3,80 €**  
**64426P** E Taille M x 1 **3,80 €**  
**64427P** E Taille L x 1 **3,80 €**  
**64687P** E Taille XL x 1 **3,80 €**



## Gant thermoplastique SafeBasics TPE

Excellente alternative à l'utilisation des gants vinyle pour  
l'industrie alimentaire. Contact alimentaire avec tous  
les aliments. Facile à enfiler. Bonne sensation des objets  
au toucher. Préconisé pour éviter la contamination des  
produits et les applications de très courtes durées.

Boîte de 100 - Bleu

**1007766** Taille M x 10 **2,90 €**  
**1007767** Taille L x 10 **2,90 €**  
**1007770** Taille XL x 10 **2,90 €**

## Distributeur de gants

Mural. En inox. Qualité alimentaire.  
L. 25 x P. 14 x H. 9 cm.

**49376P** E x 1 **P.U.HT**  
**53,50 €**





## **EMOTION BY ROBUR**

Vivre sa passion c'est se sentir bien dans sa tenue.  
C'est pourquoi ROBUR s'engage depuis 1922 à vous fournir :

**Qualité , Confort, Style et Innovation**



# VÊTEMENTS PROFESSIONNELS

VÊTEMENTS DE CUISINE.....	502
VÊTEMENTS DE SERVICE.....	511
VÊTEMENTS DE TRAVAIL.....	513
CHAUSSURES DE TRAVAIL.....	515
GUIDE DES TAILLES.....	518

## Veste Expression

Robuя POLY COTON

En polyester et coton.  
Boutons pressions cachés, parement de couleur sur poche poitrine et plastron. Col de couleur. Bande en maille ajourée sur les côtés. Poche stylo sur manche.



### Manches longues

Blanc parement noir

			P.U. HT
1004437	E Taille 0	x 1	38,00 €
1004438	E Taille 1	x 1	38,00 €
1004439	E Taille 2	x 1	38,00 €
1004440	E Taille 3	x 1	38,00 €
1004467	E Taille 4	x 1	38,00 €
1004441	E Taille 5	x 1	38,00 €
1004442	E Taille 6	x 1	38,00 €



Blanc parement gris

Taille 0 à 6

			P.U. HT
1004443 à 1004449		x 1	38,00 €



## Veste Usti

Robuя POLY COTON

Veste femme manches longues col officier avec intérieur de couleur. Coton, polyester et élasthanne. Fermée par des boutons pression cachés. 1 poche sur la manche gauche au porter, découpe princesse sur le devant. Fentes côtés, bavette de marquage milieu dos.

### Manches longues

Blanc

Taille 0 à 6

			P.U. HT
1010420 à 1010426		x 1	54,00 €



Noir parement fuchsia

Taille 0 à 6

			P.U. HT
1010413 à 1010419		x 1	38,00 €

nouveau !

## Veste Unera

Robuя POLY COTON

65% polyester, 35% coton. Col officier, fermée par des boutons pressions cachés, pinces poitrine, poche stylo plaquée sur manche gauche au porter.



### Manches courtes

Noire

Taille 0 à 6

			P.U. HT
1013271 à 1013277		x 1	29,00 €



Framboise

Taille 0 à 6

			P.U. HT
1013278 à 1013284		x 1	29,00 €



### Manches courtes

Blanc parement noir

			P.U. HT
1010386	Taille 0	x 1	35,00 €
1010407	Taille 1	x 1	35,00 €
1010408	Taille 2	x 1	35,00 €
1010409	Taille 3	x 1	35,00 €
1010410	Taille 4	x 1	35,00 €
1010411	Taille 5	x 1	35,00 €
1010412	Taille 6	x 1	35,00 €







## Veste Bama

**molinel** POLY COTON

En sergé 65% polyester, 35% coton. Col officier. Poche stylo double compartiment sur manche gauche. Revers arrondi bas de manches, boutons pressions cachés.

### Manches longues

Noir - Taille 0 à 6  **P.U.HT**  
**1010378 à 1010384** x 1 **27,00 €**



## Pantalon Exalt'r

**molinel** POLY COTON

En sergé 65% polyester, 35% coton. Légèrement taille basse. Ceinture semi-élastiquée fermée par boutons. Braguette zippée. 2 poches cavalières. 1 poche passepoilée sur le devant de la cuisse droite.

### Blanc

Taille 36 à 50  **P.U.HT**  
**1010387 à 1010394** x 1 **44,25 €**

## Veste Manille

**Robuя** POLY COTON

Fermée par des boutons pression calottes. Poche poitrine intérieure, poche stylo sur la manche gauche au porter, longueur dos = 73 cm.



### Manches longues

Blanc - Taille 0 à 6  **P.U.HT**  
**1008193 à 1008199** x 1 **26,25 €**



Noir - Taille 0 à 6  **P.U.HT**  
**1008206 à 1008212** x 1 **36,25 €**



## Pantalon Rosace

**Robuя** POLY COTON

Ceinture élastique recouverte de maille respirante. 1 poche dos fermée par un bouton pression. Pincés genoux.

### Noir

Taille 0 à 6  **P.U.HT**  
**1004450 à 1004456** x 1 **34,50 €**



### Manches courtes

Blanc - Taille 0 à 6  **P.U.HT**  
**1008186 à 1008192** x 1 **24,25 €**



Noir  **P.U.HT**

<b>1008200</b>	Taille 0	x 1	<b>34,25 €</b>
<b>1008201</b>	Taille 1	x 1	<b>34,25 €</b>
<b>1008202</b>	Taille 2	x 1	<b>34,25 €</b>
<b>1008203</b>	Taille 3	x 1	<b>34,25 €</b>
<b>1008213</b>	Taille 4	x 1	<b>34,25 €</b>
<b>1008204</b>	Taille 5	x 1	<b>34,25 €</b>
<b>1008205</b>	Taille 6	x 1	<b>34,25 €</b>



## Veste Hanska

**molinel** POLY COTON

Veste femme noir satin 50% coton 50% polyester. Col officier arrondi. Fermeture par pressions cachées. Poche stylo passepoilée sur manche gauche. Encolure plongeante. Nervures surpiquées sur côté gauche de la veste et sur revers de manche. Fentes côtés. Cilllets d'aération sous les bras.

### Manches longues

Noir  **P.U.HT**  
 Taille 36 à 50 **1010359 à 1010366** x 1 **60,50 €**



## Pantalon Umini

**Robuя** POLY COTON

En polyester et coton. Pantalon mixte noir entièrement élastiqué, poches côtés.

Convient à toutes les morphologies 

Noir  **P.U.HT**

<b>1010385</b>	Taille 0	x 1	<b>19,50 €</b>
<b>1010401</b>	Taille 1	x 1	<b>19,50 €</b>
<b>1010402</b>	Taille 2	x 1	<b>19,50 €</b>
<b>1010403</b>	Taille 3	x 1	<b>19,50 €</b>
<b>1010404</b>	Taille 4	x 1	<b>19,50 €</b>
<b>1010405</b>	Taille 5	x 1	<b>19,50 €</b>
<b>1010406</b>	Taille 6	x 1	<b>19,50 €</b>



nouveau !



### Veste Vego

POLY COTON

60 % polyester, 40 % coton. Poignets mousquetaires et boutons cousus, col chemise, intérieur et pied de col de couleur, fermé par des boutons pressions cachés, plis creux dans le dos ouvert en bas, en maille respirante, poche stylo sur manche gauche au porter, fentes côtés.

Manches longues  
Blanc parement ficelle

Taille 0 à 6

1013285 à 1013291



x 1

P.U.HT

56,50 €



### Veste Boko

POLY COTON

65 % polyester 35 % coton. Boutons pressions cachés, col ouvert avec bouton cousu pour fermeture. 1 poche plaquée poitrine. 2 soufflets d'aisance dos, fentes côtés.

Manches longues

Noir parement rouge

Taille 0 à 6

1004402 à 1004408



x 1

P.U.HT

45,25 €



### Veste Siaka

POLY COTON

50 % polyester, 50 % coton. Devant avec boutons pressions cachés + piqûre nervure. Col officier avec intérieur en éponge. 1 découpe bretelle de chaque côté du devant. Manche longue finie par un poignet ouvert. 1 poche stylo sur manche gauche avec broderie "R". 1 découpe carrure au dos. Découpe droite en maille respirante de chaque côté du dos. Bavette de marquage milieu dos. Bas veste fini par un ourlet.

Légereté 150 g  
Tissu nid d'abeille



Manches longues

Blanc

Taille 0 à 6

1008415 à 1008421



x 1

P.U.HT

49,00 €



Manches courtes

Noir parement rouge

Taille 0 à 6

1000145 à 1000151



x 1

P.U.HT

44,75 €



Manches longues

Noir

Taille 0 à 6

1004510 à 1004516



x 1

P.U.HT

49,00 €



### Veste Lonan

POLY COTON

En Sergé 65 % polyester, 35 % coton. Col kimono, intérieur en maille contrastante grise. Tissu et maille renforcés par une triplure. Manches courtes montées. 1 poche crayon plaquée sur manche gauche, double compartiment. Empiècement oblique en maille contrastante grise sur chaque devant. Fermeture frontale par pressions non apparentes, parementure gauche maintenue par des points mouche. Empiècement emmanchures dos en maille contrastante grise. Article piqué fil contrastant gris clair.

Manches courtes

Carbone

Taille 0 à 6

1010352 à 1010358



x 1

P.U.HT

42,50 €

nouveau !



### Veste **molinel** P.O.L.Y COTON Enjoy Cooking

67 % polyester, 33 % coton. Col montant avec passepoil inséré, fermeture pressions cachées, 1 pression mate sur patte en gros grain, poche stylo compartimentée sur manche gauche. Coupe ajustée, soufflet d'aisance dos réglable par patte pressionnée, oeillets d'aération sous les bras.

Manches courtes

Blanc  
Taille 0 à 6  **P.U.HT**  
**1013312 à 1013318** x 1 **36,25 €**



Noir  
Taille 0 à 6  **P.U.HT**  
**1013319 à 1013325** x 1 **39,50 €**



### Veste **RobuЯ** P.O.L.Y COTON Vulby

65 % polyester, 35 % coton. Col officier, fermé par des boutons pressions cachés, poche stylo sur la manche gauche au porter, fentes côtés.

Manches longues

Blanc rayures grises  
Taille 0 à 6  **P.U.HT**  
**1013257 à 1013263** x 1 **56,50 €**



### Veste **molinel** P.O.L.Y COTON Score

En sergé 50% polyester, 50% coton. Col officier avec partie contrastante. 2 bandes verticales noires et grises sur épaules, manches et col gris. Soufflet dos en maille. Fermeture par pressions non apparentes. 1 poche poitrine passepoilée. 1 poche stylo sur manche gauche. Fentes côtés. Oeillets d'aération sous les bras.

Manches courtes

Blanc - Taille 0 à 6  **P.U.HT**  
**1008140 à 1008146** x 1 **34,00 €**



### Veste **RobuЯ** P.O.L.Y COTON Energy

Boutons pressions cachés, parement de couleur sur plastron et poche. Col de couleur, poche poitrine. Bande en maille ajourée sur les côtés. Poche stylo sur manche.

Manches longues

Blanc parement noir  
Taille 0 à 6  **P.U.HT**  
**1004409 à 1004415** x 1 **35,50 €**

Blanc parement gris  
Taille 0 à 6  **P.U.HT**  
**1004423 à 1004429** x 1 **35,50 €**



Manches courtes

Blanc parement noir  
Taille 0 à 6  **P.U.HT**  
**1004416 à 1004422** x 1 **33,00 €**

Blanc parement gris  
Taille 0 à 6  **P.U.HT**  
**1004430 à 1004436** x 1 **33,00 €**



### Veste **RobuЯ** P.O.L.Y COTON Umyy

Fermée par des boutons pression cachés, col officier. 1 poche sur la manche gauche au porter et 1 poche poitrine passepoilée côté gauche au porter.

Manches courtes

Blanc parement pied de poule  
Taille 0 à 6  **P.U.HT**  
**1010427 à 1010433** x 1 **35,25 €**

nouveau !



### Veste **RobuЯ** P.O.L.Y COTON Vintage

65 % polyester, 35 % coton. Poinet en bord-côte, col teddy en bord-côte, fermée par des boutons pressions calottes métal, poche stylo sur manche gauche au porter et logo en bouclette, fentes côtés.

Manches longues

Blanc parement noir  
Taille 0 à 6  **P.U.HT**  
**1013264 à 1013270** x 1 **45,25 €**





## Veste Nero



Veste professionnelle manches courtes fermées par 5 boutons pressions cachés + 1 décalé. Col officier et large plastron en V. 1 poche plaquée intérieure côté gauche au porté et 1 poche stylo sur la manche gauche avec liseré.

### Manches courtes

Noir

Taille 0 à 6

1000501 à 1000507 x 1 P.U.HT 30,00 €

Moka

Taille 0 à 5

67181 à 67186 x 1 P.U.HT 30,00 €

Fuchsia

1010440	Taille 0	x 1	P.U.HT 28,50 €
1010441	Taille 1	x 1	28,50 €
1010476	Taille 2	x 1	28,50 €
1010442	Taille 3	x 1	28,50 €
1010443	Taille 4	x 1	28,50 €
1010444	Taille 5	x 1	28,50 €
1010445	Taille 6	x 1	28,50 €

Bordeaux

1010434	Taille 0	x 1	P.U.HT 28,50 €
1010435	Taille 1	x 1	28,50 €
1010436	Taille 2	x 1	28,50 €
1010437	Taille 3	x 1	28,50 €
1010469	Taille 4	x 1	28,50 €
1010438	Taille 5	x 1	28,50 €
1010439	Taille 6	x 1	28,50 €

Anthracite

1010446	Taille 0	x 1	P.U.HT 28,50 €
1010473	Taille 1	x 1	28,50 €
1010447	Taille 2	x 1	28,50 €
1010448	Taille 3	x 1	28,50 €
1010449	Taille 4	x 1	28,50 €
1010450	Taille 5	x 1	28,50 €
1010451	Taille 6	x 1	28,50 €

### Manches longues

Noir

Taille 0 à 6

69638 à 69644 x 1 P.U.HT 31,00 €

## Veste Blake



Col officier, poche crayons double compartiment sur manche gauche, revers arrondi bas de manches, boutons pressions calottés gris.

### Manches longues

Noir

Taille 0 à 6

68270 à 68276 E x 1 P.U.HT 28,75 €

### Manches courtes

Noir

66456	E Taille 0	x 1	P.U.HT 26,75 €
66457P	E Taille 1	x 1	26,75 €
66458P	E Taille 2	x 1	26,75 €
66459P	E Taille 3	x 1	26,75 €
66460P	E Taille 4	x 1	26,75 €
66461P	E Taille 5	x 1	26,75 €
66462	E Taille 6	x 1	26,75 €

## Veste Melbourne



Large plastron 2 rangées de 5 pressions inox. 1 poche poitrine plaquée intérieure gauche. Col officier. Poignets ouverts. Cèllets inox sous le bras. 1 poche stylo sur manche gauche.



### Manches longues

Blanc

62490	Taille 0	x 1	P.U.HT 24,75 €
62491	Taille 1	x 1	24,75 €
62492	Taille 2	x 1	24,75 €
62493	Taille 3	x 1	24,75 €
62495	Taille 4	x 1	24,75 €
62496	Taille 5	x 1	24,75 €
62494	Taille 6	x 1	24,75 €

## Veste de cuisine



En sergé. 50 % coton, 50 % polyester. Col officier, manches courtes montées. 1 poche crayon sur manche gauche. Cèllets d'aération sous bras. Double boutonage par boutons pressions à calotte blanche. 1 poche portefeuille plaquée à l'intérieur du devant gauche. Bavette marquage encolure dos.



### Manches courtes

Blanc

1010395	Taille S	x 1	P.U.HT 22,25 €
1010396	Taille M	x 1	22,25 €
1010397	Taille L	x 1	22,25 €
1010398	Taille XL	x 1	22,25 €
1010399	Taille XXL	x 1	22,25 €
1010400	Taille XXXL	x 1	22,25 €

## 1<sup>er</sup> PRIX



## Veste Tamise

100% COTON

100% coton. Manches longues. Boutons cousus, plastron en V, poche stylo, cèllets d'aération, double couture dos, poche intérieure.

### Manches longues

Blanc

67174	E Taille 0	x 1	P.U.HT 17,50 €
67175	E Taille 1	x 1	17,50 €
67176	E Taille 2	x 1	17,50 €
67177	E Taille 3	x 1	17,50 €
67178	E Taille 4	x 1	17,50 €
67179	E Taille 5	x 1	17,50 €
67180	E Taille 6	x 1	17,50 €



**Ceinture modèle breveté**  
Large élastique recouvert  
de tissu éponge avec système  
de réglage par velcro.  
La garantie d'un confort  
maximum.



## Pantalon Arenal



Pantalon professionnel coupe confort.  
2 poches cavalières volantes. 1 poche  
arrière passepoilée côté droit au porté.  
Braguette fermeture à glissière. Ceinture  
large sangle élastique recouverte de tissu  
éponge avec système de réglage par auto-  
grippant. 1 poche téléphone, 2 pinces au  
niveau des genoux.



Blanc				P.U.HT
63738	Taille 0	x 1		58,00 €
63740	Taille 1	x 1		58,00 €
63744	Taille 2	x 1		58,00 €
63748	Taille 3	x 1		58,00 €
63752	Taille 4	x 1		58,00 €
63756	Taille 5	x 1		58,00 €
63760	Taille 6	x 1		58,00 €



Gris chiné				P.U.HT
55511	Taille 0	x 1		58,00 €
55512	Taille 1	x 1		58,00 €
55513	Taille 2	x 1		58,00 €
55514	Taille 3	x 1		58,00 €
55515	Taille 4	x 1		58,00 €
55516	Taille 5	x 1		58,00 €
55566	Taille 6	x 1		58,00 €



Noir				P.U.HT
64438	Taille 0	x 1		58,00 €
64440	Taille 1	x 1		58,00 €
64444	Taille 2	x 1		58,00 €
64448	Taille 3	x 1		58,00 €
64452	Taille 4	x 1		58,00 €
64456	Taille 5	x 1		58,00 €
64460	Taille 6	x 1		58,00 €



## Pantalon PBO 3



Pantalon de cuisine. 65 % polyester,  
35 % coton. Ceinture à dépassant  
fermée par 2 boutons, élastique côtés,  
6 passants. 2 poches italiennes. 1  
poche arrière passepoilée et boutonnée.  
Braguette à glissière.

Noir				P.U.HT
Taille 38 à 58				
1010367 à 1010377		x 1		26,50 €



## Pantalon Timéo



Pantalon professionnel forme droite,  
braguette fermée par 3 boutons  
pressions. Ceinture fermée par un bouton  
clou, 2 passants devant et 3 passants  
dans le dos, élastique côtés, poches  
italiennes devant et poches plaquées  
derrière. Entre-jambe 82 cm.



Noir				P.U.HT
1005112	Taille 36	x 1		31,75 €
70641	Taille 38	x 1		31,75 €
70647	E Taille 40	x 1		31,75 €
70642	E Taille 42	x 1		31,75 €
70643	E Taille 44	x 1		31,75 €
70644	E Taille 46	x 1		31,75 €
70645	E Taille 48	x 1		31,75 €
70646	E Taille 50	x 1		31,75 €



Rayé noir et blanc				P.U.HT
1000119	Taille 36	x 1		32,50 €
1000120	Taille 38	x 1		32,50 €
1000121	Taille 40	x 1		32,50 €
1000122	Taille 42	x 1		32,50 €
1000123	Taille 44	x 1		32,50 €
1000124	Taille 46	x 1		32,50 €
1000125	Taille 48	x 1		32,50 €
1000126	Taille 50	x 1		32,50 €
1000127	Taille 52	x 1		32,50 €
1000128	Taille 54	x 1		32,50 €
1000130	Taille 56	x 1		32,50 €
1000129	Taille 58	x 1		32,50 €



Denim noir				P.U.HT
Taille 36 à 58				
1004524 à 1004535		x 1		30,75 €

nouveau !



## Pantalon Flex'R



Sergé 65 %, 35% coton. Ceinture en maille  
élastiquée, braguette zippée,  
2 poches italiennes, genoux préformés,  
1 poche cuisse avec rabat pressionné et  
1 compartiment stylo, 1 poche arrière  
passepoilée.

Noir				P.U.HT
1013304	Taille 0	x 1		47,50 €
1013305	Taille 1	x 1		47,50 €
1013306	Taille 2	x 1		47,50 €
1013307	Taille 3	x 1		47,50 €
1013308	Taille 4	x 1		47,50 €
1013309	Taille 5	x 1		47,50 €
1013310	Taille 6	x 1		47,50 €

1<sup>er</sup> PRIX



## Pantalon Oural



Pantalon Pied de poule en coton, bouton  
clou innarrachable, ceinture doublée  
élastiquée côté, 2 poches italiennes,  
1 poche revolver, supporte un dosage  
de chlore.

Bleu et blanc				P.U.HT
Taille 36 à 58				
67187 à 67197		x 1		19,75 €





### Toque chef **molinel** POLY COTON

En tissu 65 % polyester et 35 % coton. Taille unique. H. 25 cm, revers 4,5 cm, élastique à l'arrière, œillets d'aération.



<b>Blanc</b>		<b>P.U.HT</b>
<b>66464</b>	x 1	<b>23,75 €</b>
<b>Noir</b>		<b>P.U.HT</b>
<b>66463</b>	x 1	<b>23,75 €</b>

### Calot **molinel** POLY COTON

65 % polyester, 35 % coton. Taille unique. H. 12 cm. Bandes de tissu à lacer à l'arrière, œillets d'aération.

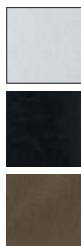

<b>Blanc</b>		<b>P.U.HT</b>
<b>66467</b>	x 1	<b>17,00 €</b>
<b>Noir</b>		<b>P.U.HT</b>
<b>66466</b>	x 1	<b>18,00 €</b>
<b>Taupe</b>		<b>P.U.HT</b>
<b>66468</b>	x 1	<b>18,00 €</b>

### Calot plat **Atlanta** 100% COTON

Calot réglable par velcro. Fond plat. H. 8 cm.

Lot de 2



<b>Blanc</b>		<b>P.U.HT</b>
<b>75554</b>	x 1	<b>8,30 €</b>

### Torchon vaisselle

52 % lin, 48 % coton. 210 g/m<sup>2</sup>. Ligné bleu. Résistance et absorption maximale.



Lot de 12

<b>L 77 x l. 50 cm</b>		<b>P.U.HT</b>
<b>32296P</b>	x 1	<b>43,25 €</b>

### Essuie-verres

100 % pur lin blanchi. Pour l'essuyage des verres et de la vaisselle fine. 180 g/m<sup>2</sup>.

100% lin



Lot de 6

<b>L 77 x l. 50 cm</b>		<b>P.U.HT</b>
<b>6329P</b>	x 1	<b>35,50 €</b>

### Torchon de cuisine 100% COTON

200 g/m<sup>2</sup>.



Lot de 12

<b>L 77 x l. 50 cm</b>		<b>P.U.HT</b>
<b>6309P</b>	x 1	<b>19,00 €</b>



### Tablier Valet

270 g/m<sup>2</sup>.

L. 102 x H. 95 cm



<b>100% COTON</b>	<b>Blanc</b>		<b>P.U.HT</b>
	<b>34444P</b>	E x 1	<b>7,70 €</b>
<b>POLY COTON</b>	<b>Bleu</b>		<b>P.U.HT</b>
	<b>34445P</b>	E x 1	<b>9,50 €</b>



### Tablier chef POLY COTON

270 g/m<sup>2</sup>.

L. 102 x H. 90 cm



<b>Blanc</b>		<b>P.U.HT</b>	
	<b>41535P</b>	E x 1	<b>6,90 €</b>
<b>Noir</b>		<b>P.U.HT</b>	
	<b>1006186</b>	E x 25	<b>9,20 €</b>



### Tablier demi-chef POLY COTON

270 g/m<sup>2</sup>.

L. 102 x H. 60 cm

<b>Blanc</b>		<b>P.U.HT</b>	
	<b>41537P</b>	x 1	<b>4,70 €</b>



### Tour de cou 100% COTON

180 g/m<sup>2</sup>. Coloris blanc.

<b>L. 100 x l. 50 cm</b>		<b>P.U.HT</b>	
	<b>6071</b>	x 20	<b>3,90 €</b>

## Tablier Nell

**molinel** POLY COTON

65% polyester, 35% coton. Tablier mixte avec 1 grande poche ventrale et 1 poche double compartiment pour stylo, décapsuleur... Fente de marche sur le devant. 215g/m<sup>2</sup>.



	Beige 1008147	x1	P.U.HT 23,00 €
	Gris 1008148	x1	P.U.HT 23,00 €
	Lie de vin 1008149	x1	P.U.HT 23,00 €
	Moka 1008150	x1	P.U.HT 23,00 €
	Chocolat 1008151	x1	P.U.HT 23,00 €
	Noir 1008152	x1	P.U.HT 23,00 €
	Rayé noir/blanc 1008153	x1	P.U.HT 26,75 €

L. 100 x H. 80 cm



## Tablier Dan

**molinel** POLY COTON

65 % polyester, 35 % coton. Tablier bavette mixte avec : 1 grande poche ventrale double compartiment et une poche pour décapsuleur, carnet, stylo... Tour de cou réglable par boutons pressions. Ciellet design et renforcé. Fente de marche sur le devant réglable par boutons pressions. 215 g/m<sup>2</sup>.



	Framboise 1008127	x1	P.U.HT 22,50 €
	Bleu aqua 1008128	x1	P.U.HT 22,50 €
	Gris 1008129	x1	P.U.HT 22,50 €
	Rouge 1008130	x1	P.U.HT 22,50 €
	Beige 1008131	x1	P.U.HT 22,50 €
	Rayé noir/blanc 1008132	x1	P.U.HT 26,50 €
	Noir 1013311	x1	P.U.HT 22,50 €

L. 100 x H. 88 cm



## 1<sup>er</sup> PRIX

## Tablier Loti

**Robuя** POLY COTON

Tablier mixte à bavette. Taille unique. Tour de cou en tissu réglable par boutons pressions. Ceinture en tissu. Poche poitrine côté gauche au porté et poche basse plaquée côté gauche au porté.



	Gris anthracite 1006102	x1	P.U.HT 15,00 €
	Chocolat 1004473	x1	P.U.HT 15,00 €
	Beige 1004472	x1	P.U.HT 15,00 €
	Noir 1000524	x1	P.U.HT 15,00 €
	Pistache 68153	x1	P.U.HT 15,00 €
	Melon 68152	x1	P.U.HT 15,00 €
	Prune 68154	x1	P.U.HT 15,00 €
	Bordeaux 68151	x1	P.U.HT 15,00 €

L. 70 x H. 90 cm



## Tablier Chypre

**Robuя** POLY COTON

Taille unique. 67 % polyester, 33 % coton. 5 poches plaquées 16 x 14 cm. Lien tour de taille. 240 g/m<sup>2</sup>.

L. 80 x H. 24 cm



	Noir 1004471	x1	P.U.HT 18,00 €
--	-----------------	----	-------------------



## Tablier sommelier

**molinel** POLY COTON

65 % polyester, 35 % coton. Tour de cou réglable. Poche décapsuleur arrondie. 2 poches devant. H. 110 cm.

	Noir 41533	x1	P.U.HT 41,50 €
--	---------------	----	-------------------



nouveau !

## Pure Denim

La Collection Pure Denim a du caractère... Elle traduit la communion parfaite entre le vêtement de mode et le vêtement de travail. Osez combiner les modèles et trouvez celui qui vous convient ! Les articles Pure Denim ne conviennent pas au nettoyage industriel. Attention : le denim peut déteindre. Évitez le contact avec un mobilier ou des vêtements de couleur claire. Deux poches sans rabat, d'une poche poitrine centrale avant. 365 g/m².



Effet jean



Tablier à bavette - Denim grège  
**1012665** L. 80 x l. 70 cm

**P.U. HT**  
x 1 **39,00 €**



Tablier - Denim bleu  
**1012663** L. 70 x l. 80 cm

**P.U. HT**  
x 1 **34,00 €**

40 % polyester, 60 % coton. 270 g/m².



Tablier - Denim noir  
**1012664** L. 75 x l. 100 cm

**P.U. HT**  
x 1 **27,75 €**



Tablier - Denim bleu  
**1012661** L. 90 x l. 65 cm



**P.U. HT**  
x 1 **41,25 €**

Authentique, légère et intemporelle. La combinaison innovante de cuir de vache et du polyester rend les tabliers valet et les tabliers chef en cuir légers moins salissants. Tous les rubans sont réglables sur mesure. Conseils de nettoyage : Les taches sur ce produit naturel peuvent être éliminées avec un chiffon humide. On peut éventuellement utiliser du savon neutre comme du savon noir pour le nettoyage. Les rubans peuvent être lavés séparément à 30 degrés. 70% cuir, 30 % polyester. 470 g/m².



Tablier - Cuir camel  
**1012659** L. 70 x l. 40 cm

**P.U. HT**  
x 1 **56,00 €**







## Veste femme Utica

En polyester, viscose et élasthanne.  
Fermée par 2 boutons cousus.



### Manches longues

Noir				P.U.HT
1008431	Taille 36	x 1		105,00 €
1008432	Taille 38	x 1		105,00 €
1008442	Taille 40	x 1		105,00 €
1008433	Taille 42	x 1		105,00 €
1008434	Taille 44	x 1		105,00 €
1008435	Taille 46	x 1		105,00 €
1008436	Taille 48	x 1		105,00 €
1008437	Taille 50	x 1		105,00 €
1008438	Taille 52	x 1		105,00 €
1008439	Taille 54	x 1		105,00 €
1008440	Taille 56	x 1		105,00 €



## Chemisier Tera

En polyester, coton et élasthanne.  
Col chemisier, devant fermé par 6 boutons cousus cachés + 1 bouton cousu sur pied de col, fentes côtés.



### Chemisier manches courtes

Blanc				P.U.HT
1006141	Taille 36	x 1		27,00 €
1006142	Taille 38	x 1		27,00 €
1006143	Taille 40	x 1		27,00 €
1006144	Taille 42	x 1		27,00 €
1006145	Taille 44	x 1		27,00 €
1006146	Taille 46	x 1		27,00 €
1006147	Taille 48	x 1		27,00 €
1006148	Taille 50	x 1		27,00 €
1006149	Taille 52	x 1		27,00 €
1006150	Taille 54	x 1		27,00 €
1006151	Taille 56	x 1		27,00 €



Poignet asymétrique et élastiqué fermé par un bouton cousu.

### Chemisier manches longues

Blanc				P.U.HT
1006130	Taille 36	x 1		28,50 €
1006131	Taille 38	x 1		28,50 €
1006132	Taille 40	x 1		28,50 €
1006133	Taille 42	x 1		28,50 €
1006134	Taille 44	x 1		28,50 €
1006135	Taille 46	x 1		28,50 €
1006136	Taille 48	x 1		28,50 €
1006137	Taille 50	x 1		28,50 €
1006138	Taille 52	x 1		28,50 €
1006139	Taille 54	x 1		28,50 €
1006140	Taille 56	x 1		28,50 €

## Pantalon Femme Gex

Pantalon à pinces, sans poches.  
1 pince piquée devant et dos piqué.  
Fermeture par un bouton cousu assorti tissu. Braguette avec fermeture à glissière. Plis marchand devant et dos.  
Bas de jambe sans ourlet. Bavette de marquage maintenue par un point d'arrêt.

74 % polyester, 20 % viscose, 6 % élasthanne. Lavable à 30°C.



Noir				P.U.HT
62369	Taille 34	x 1		36,25 €
62370	Taille 36	x 1		36,25 €
62371	Taille 38	x 1		36,25 €
62372	Taille 40	x 1		36,25 €
62391	Taille 42	x 1		36,25 €
62395	Taille 44	x 1		36,25 €
62373	Taille 46	x 1		36,25 €
62392	Taille 48	x 1		36,25 €
62393	Taille 50	x 1		36,25 €
62396	Taille 52	x 1		36,25 €
62397	Taille 54	x 1		36,25 €
62394	Taille 56	x 1		36,25 €



## Jupe Lissa

Jupe doublée polyester, viscose et élasthanne, ceinture montée.  
Fermeture dos zip et bouton.  
Fentes côtés. L. 55 cm.



Noir				P.U.HT
1004389	Taille 36	x 1		36,25 €
1004390	Taille 38	x 1		36,25 €
1004391	Taille 40	x 1		36,25 €
1004392	Taille 42	x 1		36,25 €
1004393	Taille 44	x 1		36,25 €
1004394	Taille 46	x 1		36,25 €
1004395	Taille 48	x 1		36,25 €
1004396	Taille 50	x 1		36,25 €
1004397	Taille 52	x 1		36,25 €
1004398	Taille 54	x 1		36,25 €
1004399	Taille 56	x 1		36,25 €
1004400	Taille 58	x 1		36,25 €
1004401	Taille 60	x 1		36,25 €

## LE CONSEIL

### • BIEN CHOISIR VOTRE TAILLE

Les mesures doivent être prises directement sur le corps.

### A : LE TOUR DE POITRINE

Il doit être mesuré à l'endroit le plus fort

### B : LE TOUR DE TAILLE

Il doit être mesuré bien horizontalement au creux de la taille.

### C : LE TOUR DE BASSIN

Il doit être mesuré à l'endroit le plus fort.

### Pour les vêtements femme

<b>A</b> Tour de poitrine en cm	78/81	82/85	86/89	90/93	94/97	98/101	102/105	106/109	110/113	114/117	118/121	122/125	126/129	130/133	134/137	138/141	142/145	146/149	150/153	154/157	158/161	162/165
<b>B</b> Tour de taille en cm	60/63	64/67	68/71	72/75	76/79	80/83	84/87	88/91	92/95	96/99	100/103	104/107	108/111	112/115	116/119	120/123	124/127	128/131	132/135	136/139	140/143	144/147
<b>C</b> Tour de bassin en cm	84/86	87/92	93/94	95/100	101/103	104/108	109/111	112/116	117/120	121/124	125/127	128/131	132/136	137/139	140/144	145/147	148/152	153/155	156/160	161/163	164/168	169/171
	34	36	38	40	42	44	46	48	50	52	54	56	58	60	62	64	66	68	70	72	74	76
Taille à commander	0	1	2	3	4	5	6	7	8	9	10											

Pantalon : commandez la taille correspondant à la plus grande de vos mensurations, tour de taille.





## Veste Ugo

Polyester, viscose et élasthanne. Veste homme doublée, fermée par 2 boutons cousus, fente dos, 2 poches basses avec rabat, 1 poche poitrine et 1 poche intérieure.



Manches longues

Noir

Taille 40 à 56

1008422 à 1008430



x 1

P.U.HT

105,00 €



## Gilet de service



100 % polyester. 1 poche poitrine passepoilée, 1 poche porte-feuille plaquée et 2 poches basses passepoilées. Patte de serrage dos. Entièrement doublé. 6 boutons.

Taille 0 à 4

Noir

71300 à 71304



x 1

P.U.HT

55,50 €



## Cravate Ulna

En polyester.

Noir

1008441



x 1

P.U.HT

18,00 €



## Pantalon Regular



En polyester, viscose et élasthanne. Fermeture par bouton agrafe. Ceinture droite à passants, braguette fermeture à glissière, 2 poches côtés biais et 1 poche arrière passepoilée. 2 pinces dos. Entre-jambe 90 cm, bas non terminé.

Taille 38 à 52

Noir

1006167 à 1006174



x 1

P.U.HT

43,50 €



## Chemise noire



Pied de col et poignets boutonnés, boutonnage milieu devant sous patte. Avant dernier bouton et boutonnure correspondante cousus en fil gris. 1 poche poitrine.

Manches longues

Taille 36 à 44

1006162 à 1006166



x 1

P.U.HT

24,75 €



## Chemise blanche



65 % polyester. 35 % coton.

Manches courtes

Code	Taille	Quantité	P.U.HT
71136	Taille 36	x 1	21,75 €
71138	Taille 38	x 1	21,75 €
71140	Taille 40	x 1	21,75 €
71142	Taille 42	x 1	21,75 €
71144	Taille 44	x 1	21,75 €

Manches longues

Code	Taille	Quantité	P.U.HT
71236	Taille 36	x 1	25,00 €
71238	Taille 38	x 1	25,00 €
71240	Taille 40	x 1	25,00 €
71242	Taille 42	x 1	25,00 €
71244	Taille 44	x 1	25,00 €



## Ceinture limonadier & liteau

65 % polyester, 35 % coton. 6 poches monnaie. Fermeture crochets.

Ceinture limonadier

Noir

Code	Taille	Quantité	P.U.HT
65501	Taille 0	x 1	43,25 €
65502	Taille 2	x 1	43,25 €
65504	Taille 4	x 1	43,25 €

Liteau

Blanc

6029P L.77 x 55 cm x 30



P.U.HT



P.U.HT

3,30 €



## Tablier barman



100 % PVC effet cuir gratté noir. Multipoche, pouvant recevoir monnaie, carnet de commande manuel ou électronique. Poche à rabat 15 x 18 cm. Lavable à l'éponge.

Effet cuir



L. 60 x H. 23 cm

71211



x 1

P.U.HT

60,50 €



## Tunique Laurie **HASSON** POLY COTON

65 % polyester 35 % coton. Encolure fantaisie. 1 poche poitrine avec passepoil contrasté. 2 poches basses plaquées avec passepoil contrasté. Fermeture centrale par 5 pressions couleurs ton sur ton. Fentes côtés. Longueur : 80 cm. 210 g/m².

### Manches courtes



Blanc/Rose

Taille 0 à 6

**1010248 à 1010254** E

**P.U.HT**  
x 1 **18,00 €**



Rose/Blanc

Taille 0 à 6

**1010262 à 1010268**

**P.U.HT**  
x 1 **21,75 €**



Parme/Pomme

Taille 0 à 6

**1010255 à 1010261**

**P.U.HT**  
x 1 **21,75 €**



## Chasuble Tessa **HASSON** POLY COTON

67 % polyester 33 % coton. Encolure effet cache-cœur, finition biais sur devant droit. Empiècement contrasté bas gauche. 1 poche ventrale avec poche téléphone côté droit et poche stylo côté gauche. Fermeture côtés par pattes grippers. H. dos 80 cm. 205 g/m².



Cacao/Ice

**1010243**

Petite taille (0/3) x 1

**P.U.HT**

**22,25 €**

**1010242**

Grande taille (4/6) x 1

**22,25 €**



Lin/Abricot

**1010247**

Petite taille (0/3) x 1

**P.U.HT**

**22,25 €**

**1010246**

Grande taille (4/6) x 1

**22,25 €**

## Tunique Clothilde **HASSON** POLY COTON

65 % polyester, 35 % coton. Col officier, manches fantaisies avec plis creux contrastés. 2 poches basses et 2 fentes assorties au col. Découpe princesse. Double pressions calottées. 210 g/m².



Blanc/Violet

Taille 0 à 6

**1004375 à 1004381**

**P.U.HT**  
x 1 **28,25 €**



Taupe/Framboise

Taille 0 à 6

**1004368 à 1004374**

**P.U.HT**  
x 1 **30,00 €**



Cacao/Abricot

**1010245**

Petite taille (0/3) x 1

**P.U.HT**

**22,75 €**

**1010244**

Grande taille (4/6) x 1

**22,75 €**



Blanc

**1000713**

**P.U.HT**

x 1 **11,70 €**



Noir

**1000714**

**P.U.HT**

x 1 **11,70 €**

## Legging femme **HASSON**

Taille unique. Pratique sous un pantalon en hiver, en été avec une tunique longue. 90 % polyamide, 10 % élasthanne.





## Blouse Karine **HASSON** POLY COTON

65% polyester 35% coton. Encolure en V avec parements contrastés. Poche stylo sur les 2 manches. 2 poches basses plaquées (poche téléphone côté droit porté et double poche stylo côté gauche porté). Fermeture centrale par 7 pressions. Fentes côtés. Longueur : 105 cm. 210 g/m<sup>2</sup>.

### Manches courtes

Chocolat/Rose

Taille 0 à 6

**1010235 à 1010241**

📦 **P.U.HT**  
x 1 **33,75 €**

## Gilet Urgence

**molinel**



Gilet à col montant et sans manches, fermé par une fermeture à glissière. 100% polyamide enduit polyuréthane non respirant. 1 empèchement sur chaque épaule avec un morceau de bande rétroréfléchissante. 1 poche poitrine droite plaquée pour portable fermée par un rabat et un velcro. 1 poche portefeuille intérieur gauche fermée par un velcro. 2 poches basses fermées par des velcros.

Blanc		<span>📦</span>	<b>P.U.HT</b>
<b>1010230</b>	E Taille S	x 1	<b>21,75 €</b>
<b>1010231</b>	E Taille M	x 1	<b>21,75 €</b>
<b>1010229</b>	E Taille L	x 1	<b>21,75 €</b>
<b>1010232</b>	E Taille XL	x 1	<b>21,75 €</b>
<b>1010233</b>	E Taille XXL	x 1	<b>21,75 €</b>
<b>1010234</b>	E Taille XXXL	x 1	<b>21,75 €</b>

## 1<sup>er</sup> PRIX



## Blouse Josy **HASSON**

Col V, une poche poitrine plaquée, deux poches basses plaquées, manches transformables, ceinture amovible, fermeture centrale par grippers, longueur 105 cm. 180 g/m<sup>2</sup>

### Manches courtes

Blanc

Taille 0 à 6

**79400 à 79406**

📦 **P.U.HT**  
x 1 **26,75 €**

Rose

Taille 0 à 6

**60700 à 60706**

📦 **P.U.HT**  
x 1 **29,75 €**

Parme

210 g/m<sup>2</sup>

**70054** E Taille 0 x 1 **29,75 €**  
**70055** E Taille 1 x 1 **29,75 €**  
**68173** E Taille 2 x 1 **29,75 €**  
**70056** E Taille 3 x 1 **29,75 €**  
**70057** E Taille 4 x 1 **29,75 €**  
**70058** E Taille 5 x 1 **29,75 €**  
**70059** E Taille 6 x 1 **29,75 €**

📦 **P.U.HT**  
x 1 **29,75 €**

## Polaire Diego

**HASSON**

100% polyester. 300g/m<sup>2</sup>. Polaire manches longues, deux poches basses, fermeture centrale par cinq pressions.



### Manches longues

Abricot

Taille 0 à 6

**1006154 à 1006160**

📦 **P.U.HT**  
x 1 **29,75 €**

Unisexe



## Pantalon Marc **HASSON** POLY COTON

65% polyester. 35% coton. Taille élastique. Sans poche. Entrejambe 80 cm. Unisexe.



Noir

Taille 0 à 6

**70067 à 70073**

📦 **P.U.HT**  
x 1 **27,90 €**

Chocolat

Taille 0 à 6

**70060 à 70066**

📦 **P.U.HT**  
x 1 **27,90 €**

Blanc

Taille 0 à 6

**55643 à 55649**

📦 **P.U.HT**  
x 1 **18,25 €**

## Blouse homme **molinel** 100% COTON

Traité Sanfor. Dos raglan. Fermeture par boutons. Grand teint.



### Manches longues

Bleu

Taille 0 à 6

**51590 à 51596**

📦 **P.U.HT**  
x 1 **33,25 €**

nouveau !

## GT1pro



En cuir noir. Le GT1pro Magister est la première chaussure développée spécialement pour les cuisiniers. Chaud Devant et Michelin Technical Soles en ont fait une chaussure tendance au design italien. Le cuir imperméable, la semelle antidérapante et le devant en aluminium en font la chaussure parfaite pour la cuisine. L'absence de lacets en facilite l'entretien. Chaussure de Classe S2, certifiée SRC et satisfait à la norme de sécurité EN ISO 20345:2011.



Basses - Noir

Pointure 39 à 40

**1012684 à 1012685**



x 1

**P.U.HT**

**173,00 €**

Pointure 41 à 47

**1012686 à 1012692**



x 1

**P.U.HT**

**197,00 €**



Montantes - Noir

Pointure 39 à 47

**1012666 à 1012674**



x 1

**P.U.HT**

**197,00 €**

nouveau !

## Run Classic



En microfibre. Basket de sécurité à lacets, avec aérations. Embout composite large. Semelle de contact antidérapante. Conforme à la norme CE EN ISO 20345 S1P SRC



Noir

Pointure 38 à 46

**1013349 à 1013357**



x 1

**P.U.HT**

**85,50 €**

## Ted



Mocassins avec embout de sécurité. Tige en microfibre hydrofuge S2, languette ajustable par velcro. Semelle en polyuréthane mono-densité. Lavable en machine à 30°. Conforme à la norme CE EN ISO 20345 S2 SRC.



Noir

Pointure 37 à 48

**1010541 à 1010552**



x 1

**P.U.HT**

**33,50 €**

## Sophie



Mocassins avec embout de sécurité microfibre femme conformes à la norme EN ISO 20345 SRC. Semelle à talon compensé pour un confort accru.



Blanc

Pointure 37 à 42

**1006048 à 1006053**



x 1

**P.U.HT**

**49,25 €**

Blanc

**1010745** E Taille 37



x 1

**P.U.HT**

**33,50 €**

**1010746** E Taille 38

x 1

**33,50 €**

**1010747** E Taille 39

x 1

**33,50 €**

**1010748** E Taille 40

x 1

**33,50 €**

**1010754** E Taille 41

x 1

**33,50 €**

**1010749** E Taille 42

x 1

**33,50 €**

**1010753** E Taille 43

x 1

**33,50 €**

**1010750** E Taille 44

x 1

**33,50 €**

**1010751** E Taille 45

x 1

**33,50 €**

**1010752** E Taille 46

x 1

**33,50 €**

## Dan



Mocassins de sécurité en microfibre. Embout en composite large. Semelle anti-perforation en textile composite. Semelle de contact en PU bi-densité. Conforme à la norme CE ISO 20345 S3 SRC.



Noir

**1012099** Taille 36



x 1

**P.U.HT**

**49,00 €**

**1012109** Taille 37



x 1

**49,00 €**

**1012108** Taille 38



x 1

**49,00 €**

**1012107** Taille 39



x 1

**49,00 €**

**1012106** Taille 40



x 1

**49,00 €**

**1012105** Taille 41



x 1

**49,00 €**

**1012104** Taille 42



x 1

**49,00 €**

**1012103** Taille 43



x 1

**49,00 €**

**1012102** Taille 44



x 1

**49,00 €**

**1012101** Taille 45



x 1

**49,00 €**

**1012100** Taille 46



x 1

**49,00 €**

## Quintanar



Mocassins mixtes et normés avec coque en composite, propriété antistatique du matériau, élastique intérieur au niveau de la languette, doublure de l'empigne en feutre synthétique et doublure intérieure en maille respirante, semelle intérieure amovible, normés EN345 S2.



Noir

Pointure 36 à 44

**1006093 à 1006101**



x 1

**P.U.HT**

**31,25 €**





**NORD'WAYS**  
CHAUSSANT PROFESSIONNEL

**BRICE imprimé | RUN CLASSIC**

Pour apporter le bien-être et le bonheur à vos pieds

## SABOTS AVEC EMBOUT DE SÉCURITÉ



### Sabot Bjorn

Dessus cuir. Semelle polyuréthane antidérapante. Bonne résistance aux chocs, embout de sécurité. Coquille acier. Conforme à la norme EN 20345 SRC SB E A.



Blanc - Pointure 35 à 45  
 59038 à 59048 E x1 P.U.HT 59,00 €



Noir - Pointure 35 à 45  
 59050 à 59060 E x1 P.U.HT 59,00 €



### Sabot Silvo

En microfibre, coquille acier, conforme à la norme EN 20345 SRC SB E A.



Blanc - Pointure 37 à 43  
 1004719 à 1004725 x1 P.U.HT 40,25 €  
 Pointure 44 à 46 : 1007134 à 1007136



Noir - Pointure 37 à 46  
 1013358 à 1013367 x1 P.U.HT 41,00 €



### Sabot Ezi

En éthylène vinyle acétane. Coquille composite. Conforme à la norme EN 20345 SRC SB E A.



Blanc - Pointure 37 à 43  
 1006054 à 1006060 x1 P.U.HT 39,75 €  
 Pointure 39/40 : 1006056  
 Pointure 44/45 : 1007132  
 Pointure 46 : 1007133



Noir - Pointure 37 à 43  
 1006061 à 1006067P x1 P.U.HT 39,75 €  
 Pointure 39/40 : 1006063  
 Pointure 44/45 : 1007131P  
 Pointure 46 : 1007130



### Sabot Adeline

Sabot de sécurité femme blanc/rose, normé EN ISO 20345 SRC. Semelle à talon compensé pour un confort accru. Microfibre. Coquille acier.



Blanc/rose - Pointure 37 à 42  
 1006004 à 1006009 x1 P.U.HT 49,25 €

## SABOTS SANS EMBOUT DE SÉCURITÉ



### Sabot Ezi

En caoutchouc. Conforme à la norme EN 20347.



Blanc - Pointure 37 à 43  
 1004704 à 1004709 E x1 P.U.HT 26,75 €  
 Pointure 39/40 : 1004706 E  
 Pointure 44/45 : 1007126 E  
 Pointure 46 : 1007127 E



Noir - Pointure 37 à 43  
 1005682 à 1005687 E x1 P.U.HT 26,75 €  
 Pointure 39/40 : 1005684 E  
 Pointure 44/45 : 1007128 E  
 Pointure 46 : 1007129 E



Fuchsia - Pointure 37 à 42  
 1006043 à 1006047 x1 P.U.HT 26,75 €  
 Pointure 39/40 : 1006045



Bleu ciel - Pointure 37 à 43  
 1005688 à 1005693 x1 P.U.HT 26,75 €  
 Pointure 39/40 : 1005690



### Sabot Storvik

En cuir. Conforme à la norme EN 20347.



Blanc - Pointure 37 à 45  
 1004710 à 1004718 x1 P.U.HT 58,50 €  
 Pointure 46 : 1007145

## CHAUSSURE DE SERVICE



### Escarpin Cecilia

Escarpin avec talon 4 cm. Très léger, souple supérieure, avec patin antidérapant. Microfibre.

Noir - Pointure 37 à 41  
 1006010 à 1006014 x1 P.U.HT 46,25 €



### Mocassin Patrice

Chaussure à lacets type richelieu, conforme à la norme ISO 20347 SRC. Microfibre.

Noir - Pointure 39 à 47  
 1006069 à 1006077 x1 P.U.HT 47,50 €

## BOTTES



### Bottes Delta

Bottes polyuréthane avec embout de sécurité. Doublure textile protégeant du froid. Semelle antidérapante, très bonne flexibilité, résiste aux basses températures. Conforme à la norme CE EN ISO 20345 S4 SRC CI.



Avec embout de sécurité



Blanc  
 Pointure 38 à 47  
 1010519 à 1010528 E x1 P.U.HT 47,25 €



### Botte alimentaire Béta

Les bottes (tige et semelle) sont réalisées dans un mélange spécial en caoutchouc nitrilique et PVC. Doublure textile. Conforme aux normes ISO 6112 (92). Très bonne résistance à la graisse animale et aux huiles végétales. Très bonne flexibilité, résistance jusqu'à -20 °C. Semelle antistatique et antidérapante.



Sans embout de sécurité



Blanc  
 Pointure 37 à 42  
 58794 à 58799 E x1 P.U.HT 19,75 €  
 Pointure 43 à 45  
 59000 à 59002 E x1 P.U.HT 19,75 €



VÊTEMENTS PROFESSIONNELS

# Tous les vêtements sont personnalisables à votre image.

Consultez-nous !



Broderies, transferts ou sérigraphies, nous reproduisons à l'identique votre logo.

## GUIDE DES TAILLES

**Bien choisir votre taille :** les mesures doivent être prises directement sur le corps.

**Pour les vêtements homme**

**Veste :** commandez la taille correspondant à la plus grande de vos mensurations, tour de poitrine ou tour de taille.



<b>A</b> Tour de poitrine en cm	74/77	78/81	82/85	86/89	90/93	94/97	98/101	102/105	106/109	110/113	114/117	118/121	122/125	126/129	130/133	134/137	138/141	142/145	146/149	150/153	154/157	158/161
<b>B</b> Tour de taille en cm	66/69	70/73	74/77	78/81	82/85	86/89	90/93	94/97	98/101	102/105	106/109	110/113	114/117	118/121	122/125	126/129	130/133	134/137	138/141	142/145	146/149	150/153
<b>C</b> Tour de bassin en cm	85/87	88/90	91/94	95/98	99/101	102/104	105/107	108/110	111/113	114/116	117/119	120/122	123/126	127/129	130/132	133/135	136/138	139/141	142/144	145/147	148/150	151/153
	38	40	42	44	46	48	50	52	54	56	58	60	62	64	66	68	70	72	74	76	78	80
Taille à commander	0	1	2	3	4	5	6	7	8	9	10											

**Pour les vêtements femme**

<b>A</b> Tour de poitrine en cm	78/81	82/85	86/89	90/93	94/97	98/101	102/105	106/109	110/113	114/117	118/121	122/125	126/129	130/133	134/137	138/141	142/145	146/149	150/153	154/157	158/161	162/165
<b>B</b> Tour de taille en cm	60/63	64/67	68/71	72/75	76/79	80/83	84/87	88/91	92/95	96/99	100/103	104/107	108/111	112/115	116/119	120/123	124/127	128/131	132/135	136/139	140/143	144/147
<b>C</b> Tour de bassin en cm	84/86	87/92	93/94	95/100	101/103	104/108	109/111	112/116	117/120	121/124	125/127	128/131	132/136	137/139	140/144	145/147	148/152	153/155	156/160	161/163	164/168	169/171
	34	36	38	40	42	44	46	48	50	52	54	56	58	60	62	64	66	68	70	72	74	76
Taille à commander	0	1	2	3	4	5	6	7	8	9	10											

**A.** Le tour de poitrine : il doit être mesuré à l'endroit le plus fort

**B.** Le tour de taille : il doit être mesuré bien horizontalement au creux de la taille

**C.** Le tour de bassin : il doit être mesuré à l'endroit le plus fort

**Pantalon :** commandez la taille correspondant à la plus grande de vos mensurations, tour de taille.

**INFO CONSEIL MOLINEL :** Les mesures doivent être prises directement sur le corps, sans serrer.



**Pour les vêtements homme cuisine**

**Pantalon, cotte :** commandez la taille correspondant à la plus grande de vos mensurations, tour de taille ou de bassin.

**Veste, blouson, blouse :** commandez la taille correspondant à la plus grande de vos mensurations, tour de poitrine ou tour de taille.

<b>A</b> Tour de poitrine en cm	70/74	74/78	78/82	82/86	86/90	90/94	94/98	98/102	102/106	106/110	110/114	114/118	118/122	122/126	126/130	130/134	134/138	138/142
<b>B</b> Tour de taille en cm	61/65	65/69	69/73	73/77	77/81	81/85	85/89	89/93	93/97	97/101	101/105	105/109	109/113	113/117	117/121	121/125	125/129	129/133
<b>C</b> Tour de bassin en cm	83/86	86/89	89/92	92/95	95/98	98/101	101/104	104/107	107/110	110/113	113/116	116/119	119/122	122/125	125/128	128/131	131/134	134/137
	T32	T34	T36	T38	T40	T42	T44	T46	T48	T50	T52	T54	T56	T58	T60	T62	T64	66
Taille à commander	00	0	1	2	3	4	5	6	7									
	XXS	XS	S	M	L	XL	XXL	3XL	4XL									

**Pour les vêtements homme service**

<b>A</b> Tour de poitrine en cm	70/74	74/78	78/82	82/86	86/90	90/94	94/98	98/102	102/106	106/110	110/114	114/118	118/122	122/126	126/130	130/134	134/138	138/142
<b>B</b> Tour de taille en cm	61/65	65/69	69/73	73/77	77/81	81/85	85/89	89/93	93/97	97/101	101/105	105/109	109/113	113/117	117/121	121/125	125/129	129/133
<b>C</b> Tour de bassin en cm	-	85/88	88/91	91/94	94/97	97/100	100/103	103/106	106/109	109/112	112/115	115/118	118/121	121/124	124/127	127/130	130/133	133/136
	-	34	36	38	40	42	44	46	48	50	52	54	56	58	60	62	64	66
Taille à commander	00	0	1	2	3	4	5	6	7									
	XXS	XS	S	M	L	XL	XXL	3XL	4XL									

**Pour les vêtements femme**

**Blouse :** commandez la taille correspondant à la plus grande de vos mensurations, tour de poitrine, tour de taille ou tour de hanches.

**Chemisier :** commandez la taille correspondant à votre tour de poitrine.

**Jupe :** commandez la taille correspondant à la plus grande de vos mensurations, tour de taille ou tour de hanches.

<b>A</b> Tour de poitrine en cm	74/78	78/82	82/86	86/90	90/94	94/98	98/102	102/106	106/110	110/114	114/118	118/122	122/126	126/130	130/134	134/138	138/142				
<b>B</b> Tour de taille en cm	56/59	59/62	62/65	65/69	69/73	73/77	77/81	81/85	85/89	89/93	93/97	97/101	101/105	105/109	109/113	113/117	117/121	121/125	125/129	129/133	
<b>C</b> Tour de bassin en cm	82/86	86/90	90/94	94/98	98/102	102/106	106/110	110/114	114/118	118/122	122/126	126/130	130/134	134/138	138/142	142/146	146/150	150/154	154/158	158/162	
	T32	T34	T36	T38	T40	T42	T44	T46	T48	T50	T52	T54	T56	T58	T60	T62	T64				
Taille à commander	00	0	1	2	3	4	5	6	7												
	XS	S	M	L	XL	XXL	3XL	4XL	5XL												

**A.** Le tour de poitrine : il doit être mesuré à l'endroit le plus fort

**B.** Le tour de taille : il doit être mesuré bien horizontalement au creux de la taille

**C.** Le tour de bassin : il doit être mesuré à l'endroit le plus fort





# HÔTELLERIE

PRODUITS D'ACCUEIL .....520

ACCESSOIRES DE SALLE DE BAINS .....521

ÉQUIPEMENT DE LA CHAMBRE .....528

A L'ÉTAGE .....532

HALL / EXTÉRIEUR .....534



nouveau !



### Serviette à main

Pour les mains ou le visage. Parfum thé blanc. Peut s'utiliser chaude : 10 secondes au micro-ondes. Fabriqué en France.

L. 17,4 x l. 13,2 cm P.U.HT  
**1013378P** Carton de 300 x 1 **423,00 €**



### Serviette rafraîchissante

Sous pochettes individuelle, parfum citron. Non tissé rouleau.



L. 26 x 18 cm P.U.HT  
**57196P** Paquet de 125 x 1 **29,00 €**

PRODUITS D'ACCUEIL

## SALLE DE BAIN

### Tren Sérénité



Pour recréer l'ambiance des spas dans vos salles de bain, la gamme Tren Sérénité propose une sélection de cosmétiques formulés à base de plantes.



**Shampooing 30 ml**  
 Aux huiles essentielles de Sauge.

**69569P** Carton de 300 x 1 P.U.HT  
**97,00 €**



**Gel bain douche 30 ml**  
 Aux huiles essentielles de Genévrier.

**69570P** Carton de 300 x 1 P.U.HT  
**97,00 €**



**Lait corporel 20 ml**  
 Aux extraits de Rose.

**69571P** Carton de 300 x 1 P.U.HT  
**97,00 €**



**Savon 20 g**  
 Exfoliant, parfum Thé vert.

**69565P** Carton de 350 x 1 P.U.HT  
**58,00 €**

### Tren Intense



La gamme Tren Intense vous offrira un réveil revigorant grâce à sa formulation enrichie en vitamines et oligo éléments. Produits cosmétiques testés dermatologiquement.



**Shampooing 30 ml**  
 Enrichi en pro-vitamine B5. Sans colorant. Sans paraben. Parfum Air Marin.

**69566P** Carton de 200 x 1 P.U.HT  
**76,50 €**



**Gel bain douche 30 ml**  
 Aux extraits de thé blanc. Sans colorant. Sans paraben.

**69567P** Carton de 200 x 1 P.U.HT  
**76,50 €**



**Lait corporel 30 ml**  
 Enrichi en vitamine E. Sans colorant. Sans paraben. Parfum Verveine exotique.

**69568P** Carton de 200 x 1 P.U.HT  
**91,00 €**



**Savon 15 g**  
 Aux protéines de soie  
 Parfum Air.

**69564P** Carton de 480 x 1 P.U.HT  
**69,00 €**



### 1<sup>er</sup> PRIX

### Gel cheveux et corps et savon



**Gel 7 ml** P.U.HT  
**67748P** Carton de 500 x 1 **46,50 €**



**Savon 12 gr** P.U.HT  
**69634P** Carton de 250 x 1 **25,50 €**





### Vanity kit

SÉRÉNITÉ **tren**

Boîte en carton cannelé comprenant 3 disques à démaquiller, 4 coton-tiges et 1 lime à ongles.

Carton de 250 **P.U.HT**  
**69617P** x 1 **99,50 €**



### Bonnet de douche

SÉRÉNITÉ **tren**

Emballage carton cannelé.

Carton de 250 **P.U.HT**  
**69604P** x 1 **47,25 €**



### Kit dentaire

SÉRÉNITÉ **tren**

Brosse à dent  
+ tube dentifrice 10 g.

Carton de 50 **P.U.HT**  
**69613P** x 1 **43,00 €**



### Sac plastique verre à dent

SÉRÉNITÉ **tren**

L. 18 x l. 13,5 cm.

Carton de 1000 **P.U.HT**  
**69611P** x 1 **41,00 €**



### Kit rasage

SÉRÉNITÉ **tren**

Rasoir + tube de crème à raser 15 ml.

Carton de 50 **P.U.HT**  
**69614P** x 1 **44,00 €**



### Set intime

Boite carton blanche comprenant une serviette hygiénique, un tampon, et un sac hygiène.

Paquet de 50 **P.U.HT**  
**1011588** x 1 **71,50 €**

## ACCESSOIRES SALLE DE BAIN



### Sac hygiène

SÉRÉNITÉ **tren**

En polyéthylène.

Carton de 1000 **P.U.HT**  
**69608P** L. 25 x l. 12 cm. x 1 **33,25 €**

Boîte de recharge de 25 sacs hygiène  
Boîte à insérer dans un support mural.

Carton de 100 **P.U.HT**  
**69609P** L. 25 x l. 12 cm. x 1 **210,00 €**



### Distributeur pour sacs hygiène

En plastique chrome. Distributeur avec fond adhésif pour fixer sur le mur. L. 14 x l. 9 x H. 2,7 cm.

Carton de 25 **P.U.HT**  
**1011586** x 1 **150,00 €**



### Bandes aseptiques

SÉRÉNITÉ **tren**

En polyéthylène.  
L. 44,5 x l. 4 cm.

Carton de 1000 **P.U.HT**  
**69603P** x 1 **27,25 €**



### Plateau de présentation

Petit plateau en plastique pour disposer de manière élégante les produits d'accueil dans une salle de bain. L. 24,5 x l. 10,5 x H. 1 cm.

Paquet de 25 **P.U.HT**  
**1011587** Transparent x 1 **102,00 €**



**Porte-savon**

En laiton.

**1006233**

L. 13,5 x P. 13,5 x H. 3 cm



x 1

**P.U. HT**  
**26,00 €****GARANTIE**  
**1**  
an**Porte-savon**

En laiton.

**1006232**

L. 12,5 x P. 5,5 x H. 11,5 cm



x 1

**P.U. HT**  
**26,50 €****GARANTIE**  
**1**  
an**Porte-savon**

En acrylique transparent.

**67131**

L. 12,5 x l. 8,5 x H. 4 cm



x 3

**P.U. HT**  
**10,10 €**

BathBazaar

**Distributeur simple Tokyo**

BathBazaar

En ABS. Distributeur mural de savon liquide. Capacité : 250 ml. Peut se fixer avec ou sans vis. Adhésif fourni. Design épuré. L. 6,5 x H. 22 x P. 5 cm.

**1006196**

Chromé



x 1

**P.U. HT**  
**23,75 €****Distributeur double Tokyo**

BathBazaar

En ABS. Distributeur de savon liquide compact à fixer au mur. 2 réservoirs de 250 ml. Accepte tous types de savon liquide, shampoing et lait corporel hydratant. Système de remplissage simple et rapide. Adhésif double face puissant fourni. Anti-gouttes. Visserie non fournie. L. 10 x H. 22 x P. 5 cm.

**1007788**

Chromé



x 1

**P.U. HT**  
**30,00 €****Pompe à savon**

BathBazaar

En inox. Format mini pour ce distributeur à savon liquide. Convient pour tous types de savon. 380 ml.

**66717**

L. 5 x l. 5 x H. 15,5 cm.



x 1

**P.U. HT**  
**36,75 €****Savon liquide**

BathBazaar

Enrichi de composants dermo-protecteurs aux extraits de glycérine végétale en provenance de l'agriculture biologique avec de la cardamome et de l'olive.

La cardamome garantit une action tonifiante. Sans colorants, sans parabène, sans sodium laureth sulfate.

**1007798**

1 Litre



x 1

**P.U. HT**  
**14,80 €**



## Patère

En laiton chromé.  
Patère coudée.  
Brillance éclatante.  
Élégant.  
Se distingue par sa petite fixation murale.  
Visserie fournie.

BathBazaar



Simple

67048

Ø 4,5 x L. 7 cm

x 2

P.U.HT

22,25 €

## Patère

En laiton chromé. Forme V.  
Élégante et solide.

BathBazaar



Double

1003007

L. 4 x l. 6 x H. 2,5 cm

x 1

P.U.HT

16,50 €

1<sup>er</sup> PRIX

## Patère

En laiton.

GARANTIE  
1  
an

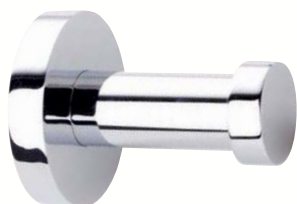

Simple

1006230

Ø 5,5 x L. 7,5 x H. 5,5 cm

x 1

P.U.HT

9,30 €

## Porte-serviettes

En laiton chromé.  
Idéal pour les petits espaces.

BathBazaar



67117

L. 40 x l. 9,5 cm

x 1

P.U.HT

54,00 €

## Sèche-cheveux clipper II



Sèche cheveux pistolet blanc sur support mural. Mise en marche par simple prise en main. Concentrateur intégré dans la forme. Nombreuses configurations de séchage dont 1 froide. Équipé d'un système ionisant. 230V. 1400 W. Cordon 35 cm. Classe II. Débit d'air de 95 m<sup>3</sup>/h.



Sans prise rasoir  **P.U.HT**  
**1010757** L. 24,5 x l. 11 cm x 1 **56,00 €**

Avec prise rasoir  **P.U.HT**  
**1010771** L. 24,5 x l. 11 cm x 1 **93,00 €**

## Sèche-cheveux Paggio



En polycarbonate. Robuste et léger. Position gauche ou droite. Compact et simple à utiliser. Sécurité : l'appareil ne fonctionne que s'il est tenu en main. Double débit d'air : 38 et 76 m<sup>3</sup>/h. 230 V. 1250 W. 50-60 Hz. Longueur de cordon spiralé : 30 cm. Niveau sonore : 60 dBA (mini) et 70 dBA (maxi). Isolation électrique : classe II. IP 21 - Installation volume 3. Certification internationale OC.





**44595P**  **P.U.HT**  
 L. 14,5 x H. 21,7 x l. 8,6 cm x 1 **40,50 €**

## Tabouret et banc

En inox brillant. Grande stabilité. Supporte 150 kg. Vis non apparentes.



Tabouret  **P.U.HT**  
**67146** L. 30 x l. 30 x H. 43 cm x 1 **139,00 €**

Existe en  
inox brossé 



Banc  **P.U.HT**  
**67147** L. 60 x l. 40 x H. 43,5 cm x 1 **190,00 €**



## Miroir grossissant

En inox. 2 faces (x1 et x7).



**67012**  **P.U.HT**  
 L. 15,5 x l. 15,5 cm x 1 **75,50 €**





### Gobelet acrylique

En acrylique.



**67004** Ø 7,5 x H. 11,5 cm x 3

**P.U.HT**  
**9,80 €**



### Gobelet emballé

Gobelet emballé individuellement.

Carton de 1000  
**1002272P** Ø 7 x H. 10 cm x 1

**P.U.HT**  
**111,00 €**

Carton de 500  
**1002287P** Ø 7,03 x H. 8,26 cm x 1

**P.U.HT**  
**44,75 €**



### Couvercle pour gobelet

En carton.



Carton de 1000  
**55611P** Ø 6,9 cm x 1

**P.U.HT**  
**120,00 €**



### Boîte à mouchoirs

Boîte avec couvercle en acrylique.



**66773** L. 7 x l. 7 x H. 12 cm x 1

**P.U.HT**  
**15,50 €**



### Boîte à mouchoirs

A poser ou à fixer.  
(Fixation murale fournie).



Inox brillant  
**67028** L. 24 x l. 12 x H. 7,5 cm x 1

**P.U.HT**  
**41,25 €**



### Mouchoir doux

En ouate de cellulose. 2 plis.



Boîte cube de 100  
**64387P** L. 12 x l. 11 x H. 12 cm x 30

**P.U.HT**  
**2,70 €**



Boîte de 100  
**1001515P** L. 23 x l. 11,4 x H. 5,2 cm x 30

**P.U.HT**  
**1,30 €**

nouveau !



### Mouchoirs

Extra doux et résistant, ecolabel, double ouverture sur la boîte. 2 plis.



Boîte de 100  
**1013685P** L. 20 x l. 19,7 x H. 5 cm x 40

**P.U.HT**  
**0,78 €**

## DRESSING



### Sac à linge

En polyéthylène. Fermeture par bande prédécoupée.  
L. 60 x l. 40 cm.



Carton de 1000  
**69610P** x 1

**P.U.HT**  
**208,00 €**



### Eponge à chaussures

Boîte en carton cannelé.



Carton de 250  
**69607P** x 1

**P.U.HT**  
**79,00 €**



### Kit couture

Set de 6 aiguilles pré-enfilées.



Carton de 50  
**69612P** x 1

**P.U.HT**  
**7,70 €**



**Dérouleur coudé**

En laiton chromé. A fixer.

**1011112** L. 16 x P. 7 cm x Ø 2,5 cm x 1 **P.U.HT 38,25 €****Support mural porte balayette**

En inox mat. Support universel, transforme balayette au sol en balayette murale pour faciliter le nettoyage des sols.

**66690** x 2 **P.U.HT 15,50 €****Dérouleur**

En laiton chromé. Dérouleur papier toilette à fixer.

**GARANTIE 1 an****1006228** L. 16 x P. 5,1 x H. 7,6 cm x 1 **P.U.HT 16,50 €****1006229** L. 17 x P. 10,7 x I. 5,5 cm x 1 **P.U.HT 16,50 €****Brosse WC avec support mural**

En inox satiné. Fournie avec visserie.

**INOX 18/10****1010796** L. 9,2 x I. 11,5 x H. 39,3 cm x 1 **P.U.HT 29,75 €****Réserve et dérouleur**

En inox brillant. Dérouleur et réserve sur pied. Sockage jusqu'à 4 rouleaux de papier WC. Ne rouille pas.

**66696** L. 15 x I. 15 x H. 45 cm x 1 **P.U.HT 31,50 €****Balayette**

Brosse en nylon noir. Base stable.

Ø 10 cm - H. 38 cm  
**66681P** Inox chromé x 1 **P.U.HT 45,00 €**  
**66682** Inox brillant x 1 **P.U.HT 43,25 €****1<sup>er</sup> PRIX****Porte balayette**

En acier inoxydable. Porte-goupillon fermé à fixer.

**1006231** Ø 8,5 x H. 38 cm x 1 **P.U.HT 48,75 €****GARANTIE 1 an****Ensemble pot et brosse WC**

En polypropylène. Pot rond + brosse boule vrac coloris blanc.



Poubelle page 493

**70202P** Ø 14 x H. 35 cm x 1 **P.U.HT 2,90 €****Abattant WC**

En polypropylène. Conception privilégiant résistance et longévité. Coloris blanc.

Bandes aseptiques page 521

**1007729P** L. 46 x I. 37 cm x 1 **P.U.HT 23,25 €**





## Rideau de douche

En Eva. Vendu sans anneaux.  
Touché doux.

BathBazaar

Motif rond transparent   
**1011111** 200 x 180 cm x 1

**P.U.HT**  
**38,25 €**



## Drap de bain et serviette Alpha

100 % COTON

400 g/m<sup>2</sup>. Fibre vierge. Blanc.

Paquet de 2 draps de bain   
**1000313P** L. 130 x l. 70 cm x 1 **16,00 €**  
**1000314P** L. 150 x l. 90 cm x 1 **23,75 €**

Paquet de 6 serviettes   
**1000311P** L. 50 x l. 30 cm x 1 **10,20 €**  
**1000312P** L. 90 x l. 50 cm x 1 **22,50 €**



## Tapis de bain blanc

700 g/m<sup>2</sup>.

100 % COTON

Blanc   
**1000317P** L. 70 x l. 50 cm x 1

**P.U.HT**  
**9,40 €**

### 1<sup>er</sup> PRIX



## Drap et serviette de bain

100 % COTON

400 g/m<sup>2</sup>. 2 liteaux plats. Blanc.

Serviettes   
**32138** L. 90 x l. 50 cm x 36 **4,20 €**

Drap de bain   
**32139** L. 140 x l. 70 cm x 18 **8,70 €**



## Peignoir

100 % COTON

Peignoir nid d'abeilles. 265 g/m<sup>2</sup>. Blanc.

Taille M   
**1006091P** H. 122 x l. 87 cm x 1 **36,50 €**

Taille XL   
**1006092P** H. 125 x l. 91 cm x 1 **36,50 €**

### 1<sup>er</sup> PRIX



## Tapis de bain blanc

650 g/m<sup>2</sup>.

100 % COTON

**32140** L. 70 x l. 50 cm x 24

**P.U.HT**  
**5,10 €**



## Serviette à mains Essence

550 g/m<sup>2</sup>. Fibre vierge. Blanc.

100 % COTON

Paquet de 12   
**1000329P** L. 33 x l. 33 cm x 1

**P.U.HT**  
**17,50 €**

## Chausson

Semelle anti-dérapante.  
Dessus coton bouclé.

Semelle fine. Bout ouvert.

Carton de 100   
**71215P** Taille unique x 1 **179,00 €**

Semelle épaisse (5 mm). Bout ouvert.

Carton de 100   
**71218P** Taille unique x 1 **184,00 €**

Semelle épaisse (5 mm). Bout fermé.

Carton de 100   
**71220P** Taille unique x 1 **196,00 €**



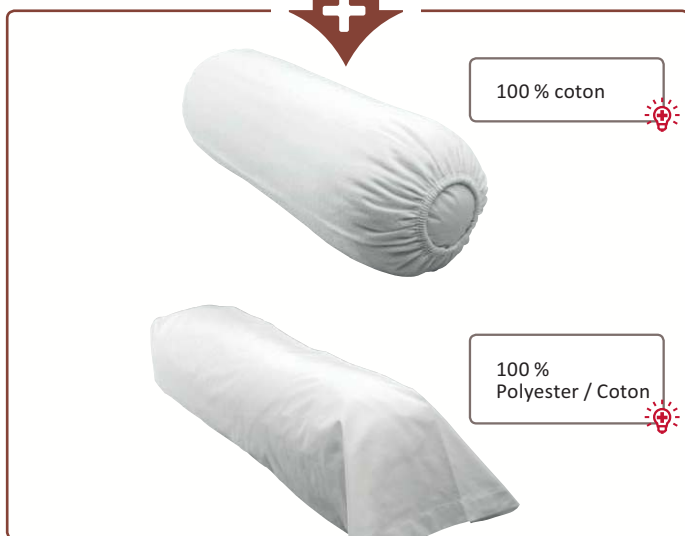

100 % coton

100 %  
Polyester / Coton

100 % polyester



100 % coton

100 %  
Polyester / Coton100 %  
Polyester / Coton

## Traversin microfibre

Enveloppe 100% polyester microfibre. Garnissage 100% polyester fibres creuses siliconnées. 70 g/m<sup>2</sup>. Poids : 900 g. Lavable à 95 °C. Conforme norme ISO 12952 / 1 à 2.

			P.U.HT
<b>1004487</b>	L. 90 x l. 22 cm	x 1	<b>14,30 €</b>
<b>1004489</b>	L. 140 x l. 22 cm	x 1	<b>17,50 €</b>
<b>1004488</b>	L. 160 x l. 22 cm	x 1	<b>18,50 €</b>

## Housse protège traversin

200 g/m<sup>2</sup>. Extrémités élastiquées.

100 %  
COTON

			P.U.HT
<b>46506</b>	L. 90 cm	x 1	<b>6,10 €</b>
<b>46507</b>	L. 140 cm	x 1	<b>9,50 €</b>

## Taie pour traversin

POLY  
COTON

			P.U.HT
<b>48686</b>	L. 140 x l. 86 cm	x 25	<b>2,60 €</b>
<b>48687</b>	L. 190 x l. 86 cm	x 25	<b>3,20 €</b>

## Oreiller microfibre

Enveloppe 100% polyester microfibre. Garnissage 100% polyester fibres creuses siliconnées. 70 g/m<sup>2</sup>. Poids : 750 g. Lavable à 95 °C. Conforme Norme ISO 12952 / 1 à 2.

			P.U.HT
<b>1004491</b>	L. 60 x l. 60 cm	x 1	<b>12,20 €</b>
<b>1004490</b>	L. 65 x l. 65 cm	x 1	<b>12,80 €</b>
<b>1004492</b>	L. 70 x l. 45 cm	x 1	<b>8,70 €</b>

## Housse protège oreiller

200 g/m<sup>2</sup>.

100 %  
COTON

			P.U.HT
<b>46504</b>	L. 65 x l. 65 cm	x 1	<b>6,90 €</b>
<b>46505</b>	L. 70 x l. 50 cm	x 1	<b>5,10 €</b>

## Taie pour oreiller

POLY  
COTON

			P.U.HT
<b>48689</b>	L. 65 x l. 65 cm	x 25	<b>2,60 €</b>
<b>48688</b>	L. 75 x l. 50 cm	x 25	<b>2,60 €</b>

## Drap

POLY  
COTON

			P.U.HT
Drap 1 personne			
<b>44638</b>	L. 310 x l. 180 cm	x 20	<b>15,25 €</b>
Drap 2 personnes			
<b>44639</b>	L. 310 x l. 240 cm	x 10	<b>20,50 €</b>

## Drap-housse

POLY  
COTON

			P.U.HT
Drap-housse 1 personne			
<b>44640</b>	L. 190 x l. 90 cm	x 20	<b>8,80 €</b>
Drap-housse 2 personnes			
<b>44641</b>	L. 190 x l. 140 cm	x 10	<b>13,50 €</b>





## Couverture Polex

100 % polyester polaire. 350 g/m<sup>2</sup>. Finition coin capuchon (4 coins coupés en biais et cousus). Lavage : 60°. Séchage rapide et facile. Ne bouloche pas. Norme ISO 12952 Non feu (1 à 4).

			P.U.HT
<b>54654</b>	L. 220 x l. 180 cm	x 1	<b>30,00 €</b>
<b>54655</b>	L. 240 x l. 220 cm	x 1	<b>35,50 €</b>
<b>54656</b>	L. 260 x l. 240 cm	x 1	<b>54,00 €</b>



100 % polyester

## Couverture Pol éco

Couverture polaire. 350 g/m<sup>2</sup>. 100 % polyester. Produits lavables et faciles d'entretien. Norme ISO 12952 Non feu (1 à 4).

			P.U.HT
<b>61107</b>	L. 220 x l. 180 cm	x 1	<b>18,50 €</b>
<b>61108</b>	L. 240 x l. 220 cm	x 1	<b>24,25 €</b>
<b>61109</b>	L. 260 x l. 240 cm	x 1	<b>30,50 €</b>



100 % polyester

## Couette

Enveloppe 100% polyester microfibre. Garnissage 100% polyester fibres creuses siliconnées. 400 g/m<sup>2</sup>. Lavable à 95 °C. Norme ISO 12952 Non feu (1 à 2). Label Oeko tex standard 100.

			P.U.HT
<b>1004495</b>	L. 200 x l. 140 cm	x 1	<b>26,75 €</b>
<b>1004494</b>	L. 200 x l. 200 cm	x 1	<b>34,75 €</b>
<b>1004493</b>	L. 240 x l. 220 cm	x 1	<b>46,00 €</b>



100 % coton

## Protège-matelas molletonné Courlis

Forme housse. 210 g/m<sup>2</sup>. Blanc.

100 % COTON

			P.U.HT
<b>6250</b>	1 personne - L. 190 x l. 90 cm	x 1	<b>14,40 €</b>
<b>6251</b>	2 personnes - L. 190 x l. 140 cm	x 1	<b>18,50 €</b>
<b>54637</b>	1 personne - L. 200 x l. 90 cm	x 1	<b>16,75 €</b>
<b>54638</b>	2 personnes - L. 200 x l. 160 cm	x 1	<b>20,50 €</b>

Entretien du linge, voir page 479



100 % coton

## Protège-matelas imperméable Toucan

Éponge bouclette. 225 g/m<sup>2</sup>. Enduction PVC. Forme housse. Blanc.

100 % COTON

			P.U.HT
<b>6245</b>	1 personne - L. 190 x l. 90 cm	x 1	<b>17,50 €</b>
<b>54640</b>	1 personne - L. 200 x l. 90 cm	x 1	<b>18,75 €</b>
<b>6246</b>	2 personnes - L. 190 x l. 140 cm	x 1	<b>22,00 €</b>
<b>54641</b>	2 personnes - L. 200 x l. 160 cm	x 1	<b>29,75 €</b>



100 % coton + polyuréthane

## Alèse

100 % coton + polyuréthane. Alèse forme drap-housse avec coton éponge bouclette (douceur). Le polyuréthane permet au produit d'être imperméable et microporeux. Produit traité anti-bactéries Sanitized.

100 % COTON

			P.U.HT
<b>61112</b>	1 personne - L. 190 x l. 80 cm	x 1	<b>22,50 €</b>
<b>61113</b>	1 personne - L. 190 x l. 90 cm	x 1	<b>23,00 €</b>
<b>61114</b>	2 personnes - L. 190 x l. 140 cm	x 1	<b>32,00 €</b>
<b>61115</b>	1 personne - L. 200 x l. 90 cm	x 1	<b>23,00 €</b>
<b>61116</b>	2 personnes - L. 200 x l. 160 cm	x 1	<b>36,75 €</b>



## PLATEAUX D'ACCUEIL



### Plateau bambou

En bambou.



L. 25 x l. 25 x H. 7 cm  
**1005751**

x 2 **P.U.HT**  
**24,00 €**

L. 40 x l. 40 x H. 7 cm  
**1005752**

x 2 **P.U.HT**  
**42,25 €**

L. 60 x l. 40 x H. 7 cm  
**1005608**

x 2 **P.U.HT**  
**52,00 €**

### Plateau d'accueil

En mélamine.



Blanc - Zen line

L. 37,7 x l. 29,7 x H. 2,4 cm  
**1010755**

x 1 **P.U.HT**  
**27,50 €**

Noir - Maestro avec encoches

L. 39,7 x l. 20 x H. 2,7 cm  
**1010756P**

x 1 **P.U.HT**  
**17,75 €**



### Plateau mélamine

Plateau mélamine angle droit. Finition brillante. Imputrescible : ne s'ébrèche pas, ne s'écaille pas.



Cerise

L. 52 x l. 35 cm  
**68760**

x 4 **P.U.HT**  
**35,50 €**



Brun

L. 52 x l. 35 cm  
**68761**

x 4 **P.U.HT**  
**35,50 €**



Noir

L. 52 x l. 35 cm  
**68759P**

x 4 **P.U.HT**  
**35,50 €**



Blanc

L. 60 x l. 40 cm  
**1004322**

x 4 **P.U.HT**  
**50,50 €**



Noir

L. 60 x l. 40 cm  
**1004323P**

x 1 **P.U.HT**  
**50,50 €**

## BOUILLOIRES



### Bouilloire Duchesse

En inox brillant. Arrêt automatique à ébullition et à vide. Rotation à 360° sur son socle. Puissance 1000 W. Alimentation 230 V.



Bouilloire 0,8 L  
**1004286P**

x 1 **P.U.HT**  
**42,50 €**



### Bouilloire Zénith

Arrêt automatique à l'ébullition et à vide. Rotation à 360° sur le socle. Témoin lumineux de fonctionnement. Puissance 1100 W. Alimentation 230 V.



Bouilloire 0,8 L  
**1010770P** E Noire  
**1013400P** Blanche

x 1 **P.U.HT**  
**35,00 €**  
 x 1 **P.U.HT**  
**35,50 €**

### Courtoisy

Innovant, première bouilloire de 0,5 L. Indicateur du niveau d'eau. Ultra compacte. Poignée ergonomique. Ouverture instinctive grâce à son système d'ouverture par bouton central. Corps inox. Alimentation 220 V. Puissance 800 W.



Bouilloire 0,5 L  
**1000752P**

x 1 **P.U.HT**  
**54,00 €**



Plateau trendy noir  
Plateau hêtre teinté noir.

L. 40 x l. 20 x H. 2,5 cm  
**1001000P**

x 1 **P.U.HT**  
**51,50 €**





### Poubelle de chambre

En polypropylène noir. Corbeille à déchets multi-usages, simple et épurée.

13,2 L  
**1011002** L. 28 x l. 21 x H. 31 cm x1 **P.U.HT 10,30 €**



### Corbeille

Design unique permettant de cacher le sac à déchets et de le maintenir en place.

10 L  
**1000429** Ø 22,5 x H. 27 cm x1 **P.U.HT 26,25 €**



nouveau !

### Coffre fort

Coffre fort hôtel motorisé.



**1004738P** L. 20 x l. 43 x H. 36,8 cm x1 **P.U.HT 149,00 €**



### Porte bagage

Sangles haute résistance + 2 sangles de maintien. Charge utile : 220 kg. Hauteur en position pliée : 86 cm.

**1000431P** L. 68 x l. 46 x H. 73 cm x1 **P.U.HT 64,00 €**



### Plaquette de chambre

PVC blanc 5/10ème. 7 langues. Recto/verso.

Paquet de 10  
**65288P** L. 20 x l. 8 cm x1 **P.U.HT 23,25 €**



### Pince jupe / pantalon

En polystyrène.

**1000375P** L. 36 cm x1 **P.U.HT 0,72 €**



### Cintre bois

En bois de lotus.

Naturel  
**1000295P** L. 44,5 cm x1 **P.U.HT 1,60 €**



Wengé  
**1000297P** L. 44,5 cm x1 **P.U.HT 1,80 €**



### Cintre avec crochet

En polystyrène.

Cintre  
**1000377P** L. 42 cm x1 **P.U.HT 0,75 €**



### Cintre bois antivol

En bois de lotus naturel  
**1000296P** L. 44,5 cm x1 **P.U.HT 1,50 €**

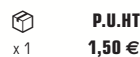

### Anneau antivol

En acier chromé. Pour cintre 1000296P.

**1000379P** Ø 3,5 cm x1 **P.U.HT 0,48 €**



### Cintre noir antivol

En polystyrène.

**1000376P** L. 42 cm x1 **P.U.HT 0,77 €**



### Anneau antivol

En polypropylène. Pour cintre 1000376P.

**1000394P** Ø 3,5 cm x50 **P.U.HT 0,65 €**





## Ibiza

**caddie** **GARANTIE 2 ans**  
Hospitality Excellence since 1928

Fiabilité, ergonomie, et discrétion : Ibiza, votre billet pour l'univers Caddie !

Structure tube d'acier revêtement peint gris clair et panneaux HPL. 4 roues pivotantes silencieuses.

3 niveaux, 1 galerie supérieure et un tiroir intérieur



**Chariot de service mini-bar**  
**1011599** L. 89,0 x l. 56,6 x  
H. 133,3 cm - 40 kg

**P.U.HT**  
x 1 **1 175,00 €**



4 niveaux, dont 3 intérieurs



**Chariot de service d'étage**

**Modèle S**  
**1011594** L. 135,5 x l. 56,6 x  
H. 133,3 cm - 34 kg

**P.U.HT**  
x 1 **1 051,00 €**

**Modèle M**  
**1011595** L. 155,5 x l. 56,6 x  
H. 133,3 cm - 39 kg

**P.U.HT**  
x 1 **1 181,00 €**

**Modèle L**  
**1011596** L. 175,5 x l. 56,6 x  
H. 133,3 cm - 45 kg

**P.U.HT**  
x 1 **1 242,00 €**



Sac amovible et lavable, en coton



**Chariot de collecte de linge**  
**A 1011597** L. 88,2 x l. 53,2 x H. 91,5 cm  
2 sacs de 80 L

**P.U.HT**  
x 1 **410,00 €**

**B 1011598** L. 88,2 x l. 53,2 x H. 91,5 cm  
1 sac de 192 L

**P.U.HT**  
x 1 **365,00 €**





Chariot petit-déjeuner  
voir page 347



**Spécial Santé**

**Chariot à linge composite**

- Construction polyéthylène monobloc :
- Accès possible par les 2 côtés.
  - 2 roues fixes (Ø 16 cm) et 2 roues directionnelles.
  - 3 rayons espacés de 27 cm.
  - Autres modèles, nous consulter.
  - 2 supports sac



**53153** L. 70 x l. 46 x H. 126 cm x 1 **P.U.HT**  
P. 56,5 cm **1 128,00 €**  
Dont Éco-participation 4,24 €

Sac à linge 100 L seul

**53155** Bleu x 1 **P.U.HT**  
**38,75 €**

**Coffre à linge**

En polyéthylène basse densité. 120 L.



**31037** L. 55 x l. 36 x H. 64 cm x 1 **P.U.HT**  
**78,50 €**

**Corbeille à linge**

En polyéthylène basse densité.



Corbeille 100 L x 1 **P.U.HT**  
✔ **4277** L. 72 x l. 48 x H. 29 cm **33,25 €**



Corbeille 130 L x 1 **P.U.HT**  
**4278** L. 79 x l. 57,5 x H. 29 cm **39,25 €**

**Chariot à linge vrac**

Chromé. Structure tube Ø 25 mm. Roues sans frein Ø 10 cm.  
Livré avec sac tissé lavable 100 L.



**70337** L. 70 x l. 44 x H. 98 cm x 1 **P.U.HT**  
Dont Éco-participation 0,18 € **393,00 €**

Sac à linge 100 L seul

**70338** L. 55 x l. 40 cm x 1 **P.U.HT**  
**121,00 €**

nouveau !

**Sonnette de comptoir**

En métal chromé.

**APS****1013665P**

Ø 8,5 x H. 6 cm



x 1

**P.U. HT**  
**4,10 €****Porte-clé plexi anti-choc**

Rectangle. Personnalisable. Bristol amovible personnalisable à souhait. Talon anti-choc pour la protection de vos portes.

**53519**

l. 4,8 x H. 10 cm



x 200

**P.U. HT**  
**17,50 €****1<sup>er</sup> PRIX****Porte-clé Altuglass**

Rectangle format spécial carte de visite. Avec anneau. Personnalisable.

**53724P**

l. 5,5 x H. 9 cm



x 1

**P.U. HT**  
**8,20 €****Penderie mobile**

Structure tubulaire rectangulaire 35 x 20 mm. 4 roues pivotantes Ø 8 cm. Grille galerie pour chapeaux en option.

**SAINT ROMAIN****53733**

L. 120 x l. 50 x H. 167 cm



x 1

**P.U. HT**  
**385,00 €**

Dont Éco-participation 0,16 €

**Numéros de vestiaires**

Indispensables pour les vestiaires des restaurants, discothèques... Un coupon à accrocher au cintre, deux coupons pour le client (manteau et accessoire). Numérotation de 001 à 1000. Collé. l. 3 x L. 20 cm.



Paquet de 1000

**69450P** Rouge  
**69449P** Rose  
**69448P** Jaune  
**69451P** Vert

x 1

**P.U. HT**  
**53,50 €**  
**53,50 €**  
**53,50 €**  
**53,50 €****CORDONS ET POTEAUX****Cordon****Securit**

Pour poteaux d'accueil. Embouts or ou chromés. L. 1,5 m x Ø 3,8 cm. Les cordons bronze et noir sont faits à partir de cordes tressées en satin. Les cordons rouges et bleus sont faits en velours.

Noir / Chromé  
**1004082**

x 1

**P.U. HT**  
**35,25 €**Rouge / Chromé  
**1004084**

x 1

**P.U. HT**  
**29,25 €****Poteau pour cordon****Securit**

En inox brossé. Modèle or à tête ronde ou chromé à tête plate, d'une hauteur d'1 m. Placé idéalement à l'entrée de votre établissement ou pour délimiter les zones d'attente. Pour un usage extérieur ou intérieur, d'une grande stabilité grâce à son socle de 12 kilos.

Chromé  
**1004086**

x 1

**P.U. HT**  
**69,50 €****Poteau à corde rétractable****Securit**

En inox brossé à corde rétractable de 2,10 m de long et 3,5 cm de hauteur. La corde est incluse dans le set avec le poteau. Pour un usage extérieur ou intérieur, d'une bonne stabilité grâce à son pied lourd. Hauteur du poteau : 1 m.

Rouge  
**1004090**

x 1

**P.U. HT**  
**79,50 €**Noir  
**1004089P**

x 1

**P.U. HT**  
**79,50 €**



## TAPIS

### Aqua 45

En polypropylène et polyamide. Destiné à être utilisé comme tapis de propreté aux entrées des bâtiments afin de capter les saletés et absorber l'eau sous les chaussures des visiteurs.

Usage intérieur et extérieur.  
Faible trafic

Noir d'ébène  
**1001402P** L. 90 x l. 60 cm x 1 **P.U.HT 56,00 €**  
**1001401P** L. 150 x l. 90 cm x 1 **123,00 €**

Trafic normal

Gris Ardoise  
**1000374P** L. 150 x l. 90 cm x 1 **P.U.HT 156,00 €**

GARANTIE **1** an

### 1<sup>er</sup> PRIX

### Softex

En polyamide.

Usage intérieur

Gris Chiné  
**1001404P** L. 60 x l. 40 cm x 1 **P.U.HT 15,25 €**  
**1001403P** L. 90 x l. 60 cm x 1 **29,75 €**

## CENDRIERS

### Cendrier mural

Inox et acier galvanisé résistant à la rouille et aux rayons UV. Bac intérieur permettant un vidage aisé et rapide. Fermeture à clé. Kit de montage au mur inclus.

Cendrier 1,5 L  
 Capacité 150 mégots  
**63621** L. 15,2 x l. 6,4 x H. 25,5 cm x 1 **49,25 €**

Cendrier 3 L  
 Capacité 350 mégots  
**62169** L. 19,1 x l. 6,4 x H. 35,5 cm x 1 **P.U.HT 71,50 €**

### Cendrier borne

Cendrier sur pied en acier galvanisé avec revêtement anti-rouille et anti-UV. 4 points d'accès en inox pour éteindre les mégots. Fermeture à clé (fournie). Kit de montage et de fixation au sol inclus. Base lestée.

Cendrier 3 L  
 Capacité 350 mégots  
**66623** Ø 30 x H. 108 cm x 1 **P.U.HT 174,00 €**

### Cendrier mural Disco

En acier poudré polyester avec grille écrase-mégots. Résistant aux intempéries et simple d'utilisation. Facile et rapide à vider. Gris manganèse.

Cendrier 0,5 L  
 Capacité 50 mégots  
**1000330P** L. 18,7 x l. 4,5 x H. 18,5 cm x 1 **P.U.HT 38,00 €**

### Cendrier totem

Cendrier d'extérieur sur pied en acier galvanisé et inox. Extinction des mégots sur deux faces. Traité anti-rouille et anti-UV. Bac intérieur avec étouffoir intégré. Vidage rapide du bac par la porte latérale verrouillable. Clé, kit de montage et de fixation au sol inclus. Base lestée (7 Kg).

Cendrier 12,5 L  
 Capacité 1250 mégots  
**62170** L. 40 x l. 26 x H. 104 cm x 1 **P.U.HT 204,00 €**

### Cendrier collecteur

Collecteur en acier inoxydable avec corbeille 20L et cendrier - tiroir 2,3L. Revêtement adapté pour une utilisation en extérieur : résistant à la rouille, à la corrosion et aux rayons UV. Simple et rapide à vider par ouverture frontale. Fermeture à clé. Kit de fixation au sol inclus pour éviter le vol.

Cendrier 2,3 L  
 Capacité 300 mégots  
**65327** L. 33 x l. 28 x H. 88 cm x 1 **P.U.HT 327,00 €**

### 1<sup>er</sup> PRIX

### Cendrier Collecteur

Utilisation en intérieur et en extérieur protégé. Bac intérieur avec poignée en acier galvanisé. Cendrier amovible en aluminium. Rebords, ouverture et base en caoutchouc pour éviter les coupures, les rayures au sol et les produits détergents. Contenance 30L.

Ø 25 x H. 65 cm  
**65326** Epoxy noir x 1 **P.U.HT 123,00 €**

Ø 25 x H. 65 cm  
**69681** Inox satiné x 1 **P.U.HT 165,00 €**

# A

Abattant WC	476, 526
Abrasifs	480
Absorbant Neutralisant	475
Acapulco verrerie	178
Accessoires / Couverts de spécialités	205
Accessoires à Vin	237, 512
Accessoires de coutellerie	426, 427
<b>Accessoires de table</b>	<b>206 à 229</b>
Accessoires salle de bain	522 à 525
Accessoires vêtements professionnels	508
Accessoires WC	476, 526
Acrylic3	251
Adagio couverts	198
Affûteur manuel / affûteuse électrique	425
Agitateurs	176, 309
Aiguilles à brider inox	425
Aiguillage	423 à 425
Ais verrerie	153
Alaska couverts	191, 203
Alèses	529
Alinea couverts	190, 203
Alizée verseuse isotherme	267
Alkaline couverts	185
Allegro verrerie	150, 171
Allspice vaisselle	34
<b>Aluminium et films</b>	<b>398 à 455</b>
Amande couverts	201
Amelia verrerie	149
America salière	212
Ametista verrerie	154
Andréa moulin à poivre/sel	211
Anna vaisselle	39
Anneaux antiviol	531
Anser couverts	195
Antillaise verrerie	177
Antique moulin à sel/poivre	209
Appareils à raclette	105
Araignées	434/435
Arborescence vaisselle	55
Arcade couverts	195, 203
Architecte verrerie	163
Arcoroc vaisselle	90 à 96
Ardoise vaisselle	93
Ardoise Woody	227
Ariane vaisselle	61 à 69
Ariel lessive	479
Armoire à pharmacie	492
Armoire de maintien en température	465
Armoire de stérilisation	426
Armoires d'entretien	492 à 494
Armoires inox	337
Arobase couverts	197
Arom'up verrerie	137, 171
Aroma cafétérie	133
Arôme verrerie	123
Arpège verrerie	155
Artesano vaisselle	23
Artic vaisselle	75
Artic verrerie	160
Artisan vaisselle	62, 63
Artiss corbeille	206
Artois verrerie	152
<b>Arts de la table</b>	<b>12 à 285</b>
Aruba couverts	191
Aspirateurs	485

Assiettes à compartiments	100
Assiettes à pâtes	103
Assiettes à usage unique	306
Assiettes anti-dérapantes	100
Assiettes carton	306
Assiettes catalanes	117
Assiettes plastique	306
Assiettes régithermie	97
Astoria pichet isotherme	267
Atoll mignardise	123, 124
Attache murale pour collecteur	496
Attendrisseur	425
Aurea vaisselle	34
Aurum verrerie	146, 216
Autocuiseur	407
Aztek couverts	198

# B

Bac à glaçons	233
Bacchus verrerie	170
Bacs à ingrédients	356, 357
Bacs Bank	412
Bacs copolyester	413
Bacs de manutention	356
Bacs et caisses	353 à 355
Bacs gerbables	354
<b>Bacs GN cuisine</b>	<b>410 à 414</b>
Bacs inox	410, 411
Bacs mélamine	271
Bacs plats emboîtables	353
Bacs polypropylène	414
Bacs pour assiettes	355
Baguette PM couverts	196, 203
Baguettes chinoises	104
Bahia vaisselle	51
Bahuts à débarasser	441
Bain-marie	387
Balais	483
Balances d'appoint	395
<b>Balances de cuisine</b>	<b>394, 395</b>
Balances de laboratoire	395
Balances de réception	394
Balayette bois	453
Bali verrerie	178
Ballon verrerie	152, 171
Baltic moulin à sel/poivre	210
Baltik couverts	200
Bamboo vaisselle	83, 92
Bandeau dépoussiérage	482
Bandeau lavage microfibre	482
Banquet vaisselle	40, 41
<b>Bar matériel</b>	<b>230 à 239</b>
<b>Bar verrerie</b>	<b>163 à 179</b>
Barclay présentoirs	254
Barista cafétérie	37, 130
Barquettes aluminium	324
Barquettes chaleur	322, 323
Barquettes charcutières	320
Barquettes en bois	325
Barquettes fraîcheur	321
Barquettes micro-ondables	323
Barquettes scellables	327
Barres aimantées	425
Barres porte-fiches	329
Barrettes de séparation	410

Bars à sauces	276
Basalt vaisselle	56, 57
Bassine à friture bombée	407
Bassines pâtisseries	446
Bassines plastique hygiène	481
<b>Batterie de cuisine</b>	<b>401 à 405</b>
Battes à côtelettes	425
Batteur à pétrin	374
Batteurs mélangeurs	373, 374
Baya verrerie	157, 177
Bazik noir vaisselle	85
Bazik vaisselle	89
Be Bop vaisselle	91
Be bop verrerie	167
Becs verseur	236
Belle cuisine vaisselle	109
Bermudes vaisselle	87
Bière verrerie	173
Billy photophores	220
Bistro moulin à sel/poivre	208, 209
Bistronome vaisselle	111
Bistrot vaisselle	77
Blenders	375
Blister siphon	445
Blixers	366
Bloc Aimanté coutellerie	415
Blocs addition	329
Blocs brasserie	329
Blocs commandes	329
Blois couverts	189
Blossom vaisselle	21
Blouses Homme / Femme	514
Blouses jetables	499
<b>Bobines CB / bobines caisse</b>	<b>329</b>
Bobines essuyage	486
Bobines industrielle	487
Bois de tuya couteau	204
Boîte à thé	261
Boîtes à épices	453
Boîtes à ingrédients	453
Boîtes à mouchoirs et cotons	525
Boîtes à pizza	318
Boîtes burger	316
Boîtes chaleur	322
Boîtes fraîcheur	321
Boîtes micro-ondable	322
Boîte plats chauds	322, 323
Boîtes plats froids	320, 321
Boîtes traiteur	311
Bolée à cidre	113
Bolero verrerie	178
Bonbonnière	253
Bormioli Rocco vaisselle	97
Boston shaker	233
Bottes alimentaires	517
Bouchon à champagne	237
Bougies anniversaire	223
Bougies chauffe plat	222
Bougies flambeaux	223
Bougies flottantes	222
Bougies LED	220
Bouilloires	530
Boule à thé	128
Boules inox	480
Box combi	459
Brasserie vaisselle	69
Brillant Breton argenterie	472

Brio verrerie	171	Casiers de lavage	348, 349	Coco photophores	221
Brioche moules	448, 449	Casiers pour plateaux	349	Cocoon vaisselle	272
Briquet allume bougies	223	Casquettes résille	498	Cocottes fonte	408, 409
Broadway verrerie	163, 172	Casse pattes à homard	104	Coffres à linge	533
Brochette bois / inox	102	Casseroles	401 à 403	Coffres forts	531
Brocs mesures gradués	441	Ceinture limonadier	512	<b>Collecte des déchets</b>	<b>493 à 497</b>
Brosse à main et à ongles	482	Célébration vaisselle	86	Colosseo verrerie	149
Brosse à pétrin	444	Céleste vaisselle	83	Colour Prof coutellerie	420
Brosserie hygiène	483	Cendriers bornes	535	Combi-Mixers	370
Brosserie métallique	427	Cendriers collecteurs	535	Combinés centrifugeuse/mixer blender	378
Brosses papillon	482	Cendriers muraux	535	Combinés cutter/coupe-légumes	364
Brotstation boîte à pain	261	Cendriers Totem	535	Combinés sanitaire	476, 526
Broyeur à glaçons	233	Cercles pâtisserie	452	Combustible chafing dish	265
Brush vaisselle	94	Chafing Dish	264	Concept décor	288 à 290
Brushwood vaisselle	65	Chalumeaux	175	Concept Shoreline	101
Bubble verrerie	125, 179	Charente verrerie	170	Concerto verrerie	125, 165
Budelle verrerie	217	Chariot bains-marie	465	Concrete vaisselle	17
<b>Buffet</b>	<b>246 à 277</b>	Chariot de service d'étage	532	Conica verrerie	217
Buffets Petit déjeuner	254 à 263	Chariot de service mini-bar	532	Conique verrerie	169
Butcher's line	421	Chariots à linge	532, 533	Conservation des vins	238
Buzz verrerie	126	Chariots à niveau constant	339	Contact Grill	384
		Chariots cafétéria	344	Containers extérieurs	497
		Chariots chauffants	393	Conteneur isotherme	461
		Chariots de ménage	485	Conteneur Thermax	464
		Chariots de service	345, 346	Conteneurs GN	460
		<b>Chariots et échelles</b>	<b>339 à 347</b>	Conteneurs isothermes pour boissons	461
		Chariots Euronormes	342	Conteneurs multi-usages	356
		Chariots Gastronomes	343, 344	<b>Conteneurs UPC/UPCS/UPCH</b>	<b>462</b>
		Chariots petit déjeuner	347	Coquetiers	115
		Chariots pliants	341	Coquilles st jacques	324
		Chariots porte-assiettes	340	Coquilleurs à beurre	429
		Chariots porte-bacs	341	Corbeilles à fruits	237
		Chariots porte-casiers	352	Corbeilles à linge	533
		Chariots porte-plateaux	339	<b>Corbeilles à pain</b>	<b>206, 207, 263</b>
		Charlottes	498	Corbeilles buffet	261 à 263
		Chasubles	513	Cordons pour poteaux	534
		Chauffe-assiettes	393	Cornes	444
		Chauffe-briques	387	Côte à l'os coutellerie	204
		Chauffe-chocolat	388	Couettes	529
		Chauffe-eau	379	Coupe unie champagne	171
		Chauffe-plats	265	Coupe-frites	432
		Chauffe-saucisses	387	Coupe-fruit	235
		Chaussons hôtellerie	527	Coupe-légumes électriques	362
		Chaussures de service	517	Coupe-légumes manuel	432
		<b>Chaussures de travail</b>	<b>515 à 517</b>	Coupe-pain	424
		Chef & Sommelier couverts	187	Couperets	425
		Chef & Sommelier vaisselle	14 à 19	<b>Coupes à desserts</b>	<b>177 à 179</b>
		Chef's Fusion vaisselle	106, 107	Coupes œufs	428
		Chemises homme	512	Coupe-volaille	425
		Chemisiers femme	511	Couteau à génoise	424
		Chevalets de table	226	Couteaux à abattre	425
		Chevalets de trottoir	227	Couteaux à fromage	205, 424
		Chic & Mat vaisselle	76	Couteaux à huître	104
		Chiquito verrerie	123	Couteaux à jambon / saumon	424
		Cintres	531	Couteaux à pain	421, 424
		Circée verrerie	177	Couteaux à pamplemousse	429
		Ciseaux à poisson	424	Couteaux à pizza	205
		Ciseaux de cuisine	425	Couteaux à poisson	424
		Ciseaux électriques	285	Couteaux à raclette	105
		Claies à porter	263	Couteaux à steak	204
		Classic square vaisselle	86	Couteaux à tomates	235, 429
		Clip d'identification pour casier	348	Couteaux d'office	417, 419, 422
		Clip LED	221	Couteaux pour coupes légumes /cutters	365
		Cloche inox	268	Couteaux pour surgelés	424
		Club vaisselle	57	<b>Coutellerie</b>	<b>415 à 425</b>
		Cocktail Master	232	Couvercle pour casier de lavage	348
		Cocktail verrerie	170	Couvercle gobelet hôtellerie	525

## C

Cabernet verrerie	142, 170
Cadres pâtisserie	452
Caféteria blanche	68, 130 à 132
Caféteria couleur	129
Caféteria inox	128
Caféteria verre	133
Cafett caféteria	132
Cafett vaisselle	116
Caffeino caféteria	133
Caillebotis	357
Caisses à génoise	450
Caisses à pâtons	453
Caisses à vaisselle	355
Caisses ajourées	353
Caissettes	325
Cakes (moules)	450
Caleido caféteria	133
Cales de table	285
Calots non tissé	498
Calots papier	498
Calots textile	508
Calypso verrerie	164
<b>Cam Gobox conteneurs</b>	<b>460</b>
Campus verrerie	161
Camshelving rayonnage	332, 357
Canaries verrerie	179
Canneleurs décozesteur	235, 429
Canopée vaisselle	47
Caquelons	105
Carafe à débit régulé	215
Carafe copolyester	215
<b>Carafes</b>	<b>215 à 219</b>
Carafes à décanter	216
Carafes incassables	215
Carat verrerie	124, 179
Carlton couverts	197
Carrés rainés	311
Cartes menus	225
Cartouches gaz	445
Casier à objets creux	349
Casiers à assiettes	349
Casiers à couverts	349

Couverts jetables	307
Couverts de spécialité	205
<b>Couverts de table</b>	<b>183 à 205</b>
Couverts enfants	99
Couverts handicap	201
Couverts mignardises	126, 315
Couverts spécifiques	201
Couvertures lits	529
Couvres-assiettes	458
Couzon couverts	185, 186, 194
Craquelée verrerie	216
Cravate	512
Crème à recurer	477
Crème lavante mains	489
Crêpières	388
Cruchons de javel	475
Cuillère en bois	438
Cuillère mesure bar	233
Cuillères à glace	205
Cuillères à mélange	233
Cuillères à pommes/melons	429
Cuillères amuse-bouche	121
Cuiseurs à oeufs	387
Cuiseurs à pâtes / à riz	387
<b>Cuisine</b>	<b>331 à 455</b>
Culs de poule plastique	446
Cure dents	315
Curettes à homard	104
Cutters électriques	363
Cuvettes	356, 481
Cyclade verrerie	179

## D

D.O.C. verrerie	144
Daman moulin à sel/poivre	208
Damas coutellerie	416
Darioles	448
Déboucheurs sanitaires	477
Décapants four	473
Décapsuleurs	238
<b>Déchets (collecte)</b>	<b>495 à 499</b>
Décofruits	429
Décoration glace	176
Découpoirs	451
Dégraissants	473 à 475
Dégraissants Désinfectant	474
Dégraissants friteuse et hotte	473
Dégraissants multi-surfaces	475
Dégraissants sol	475
Dégraissants surfaces	475
Degrenne couverts	189, 194
Degrenne vaisselle	51
Degscharf coutellerie	417
Dégustation verrerie	172
Delisséa caféterie	68
Demilys nappage textile	281
Dentelles	311
Dépoussiérage	481
Dérouleurs housses échelles	343
Dérouleurs papier hygiénique	526
Désinsectiseurs	492
Désodorisant textile	479
Désodorisants	477, 478
<b>Desserts vente à emporter</b>	<b>319 à 323</b>
Dessous de bouteille	237

Destructeurs d'odeurs	478
Détartrant machine	473
Détartrant sanitaire	476
Détartrants Désinfectant	476
Détartrants machine à café	381
Détergent dégraissant	474
Détergent désinfectant	474
Détergent multi usages	475
Détergent Teepol	475
Diablos manutention	352
Diamond cafétérie	133
Diamond coupe dessert	179
Diamond vaisselle	93
Diamond verrerie	160, 165
Digestifs verrerie	172
Disco verrerie	124, 172
Disques pour robots	365
Distributeur à lait réfrigéré	261
Distributeur à miel / sirop	214
Distributeur boissons	262
Distributeur de calots / charlottes	498
Distributeur de masques	498
Distributeur de savon	489
Distributeur de torchons	487
Distributeur essuie mains	488
Distributeur individuel pressable	276
Distributeur Invertatop	276
Distributeur kits visiteurs	499
Distributeur papier hygiénique	490, 491
Distributeur savon Tokyo	522
Distributeur Top Kilner	261
Distributeurs / Doseurs bar	236
Distributeurs à céréales	262
Distributeurs agitateurs	309
Distributeurs de gants	499
<b>Distributeurs et bobines</b>	<b>486 à 491</b>
Distributeurs pour film/aluminium	455
Diviseur à tomates	432
DOC verrerie	153
Dolce caféterie inox	128
Dolce caféterie verre	133
Dolomiti verrerie	165
Domaine verrerie	147
Dôme à côtes	448
Dortmund verrerie	173
Doseurs bar	236
Douilles	445
Drap de bain et serviettes	527
Draps / draps housse	528
Dream verrerie	171
Dressage de précision	439
Dublino verrerie	126, 172
Dunicel nappage	293
Duniletto serviettes	304

## E

Easy bar caféterie	133
Ecailleur poisson	424
Echelles / Housses	342, 343
Eclat argent	472
Eco couverts	201, 213
Eco max couverts	200
Ecobaguettes couverts	199
Ecoline pochettes	305
Ecoplus batterie de cuisine	403

Ecuelles bretonne	113
Ecumoiros	434
Edina vaisselle	82
Efface taches	480
Egouttoir friture	440
Egouttoirs	414
Ekta vaisselle	86
Élégance verrerie	150
Elisa verrerie	148, 156
Elixir bottle	214, 232
Ellipse verrerie	125
Eminceur à cornichons	429
Emotions caféterie	139, 131
Emporte-cœur	429
Emporte-pièces	451
Enregistreurs de température	397
Entonnoirs	441
Epivac Duo	238
Epluche-légumes	429
Eplucheurs légumes	432
Eponges	480
Equeuteurs à tomates	429
Equinox vaisselle	54
Equinox verrerie	124
<b>Équipement de la chambre</b>	<b>495 à 531</b>
<b>Équipement de la personne</b>	<b>498, 499</b>
<b>Équipement salle de bain</b>	<b>521 à 527</b>
Escale vaisselle	12
Escarpins	517
Eskale verrerie	123, 167
Esses	425
Essuie-tout	487
Essuie-mains	488
Essuie-verres	508
Este verrerie	164
Etagères inox	338
Eternity vaisselle	17
Eternum couverts	183, 199
Étiqueteuses	399
Étiquettes	398, 399
Étiquettes autocollante thé/café	267
Étiquettes repas témoin	398
Etove verrerie	178
Etuve incubateur	399
Evento buffet	258, 264
Evercut coutellerie	415
Evolin nappage	292
Evolution coutellerie	202
Evolution vaisselle	45
Executive verrerie	173
Explore verrerie	216
Expression coutellerie	202
Extracteurs de jus	377
Ezzo couverts	187

## F

Fer à caraméliser	446
Feston vaisselle	96
Feuilles anti-goutte	237
Feuilles de boucher	425
Feutres craie	226
Feutres craie waterproof	226
Fibrox coutellerie	419
Fidji verrerie	178
Fido verrerie	123, 124
Film de cuisson	455

Film PVC	454
Filtre à huile	386
Filtres papier	381
Fine Dine vaisselle	35
Fjord couverts	199
Flash food thermomètre	396
Fluid verrerie	123, 217
Flûtes verrerie	171
Flûtes jetables	308
Flûto cafétéria	130
Folia vaisselle	83, 104
Fontaines lumineuses	223
Fortuna verrerie	177
Forum verrerie	161
Fouets cuisine	435, 438
Fouets pour mini-mixer	369
Four à convection	391
Fours micro-ondes	390, 391
Fourchettes à fondue	105
Fourchettes à viande	435
Fourchettes diapason	439
Fourchettes métal	315
Fours	390
Fragment vaisselle	15
Frame vaisselle	67
Frangé pour lavage à plat	484
Frida couverts	199 à 273
Friends verrerie	165
Friteuses	386
Froissé cafétéria	129
Fromagères	103, 214
Fumoirs	361
Fushi coutellerie	421
Fusils à aiguiser	423
Fusion verrerie	167, 202

## G

Galaxy couverts	190
Gants de cuisine	426
Gants jetables (nitrile, latex, vinyle)	499
Gants ménage	499
Gaufriers	388
Gaze lavage sol	481
Gel sanitaire	476
Gels cheveux et corps	520
Gels combustibles	265
Gem verrerie	124, 172
Génération Y coutellerie	416
Giara verrerie	219
Gigogne verrerie	126, 161
Gilets barmans	512
Gilets froids	514
Gin verrerie	126, 172
Ginseng Black & Grey vaisselle	23
Giro vaisselle	36
Glacette	231
Gobelet emballé	525
Gobelets couleurs	157 à 160
<b>Gobelets de table</b>	<b>154 à 161</b>
Gobelets jetables	308
Gobelets verre trempé	147 à 149
Godets aluminium	324
Godets prélèvements	398
Goliath coutellerie	203
Goupillons nylon	483

Gourmet vaisselle	37
Gran chaco coutellerie	204
Grand Chef coutellerie	417
Grand Chef vaisselle	50
Grands Cépages verrerie	141
Granity verrerie	125, 168
Grattoir de plot	427
Grattoir plancha	385
Grattoir vitres	478
Grès couleur vaisselle	78
Grès pichets	219
Grille pour urinoir	477
Grille-pains	383
<b>Grilles inox</b>	<b>443</b>
Grilles à pizza	453
Grills / Salamandre	384
GT1PRO chaussures	515
Guide casiers de lavage	350, 351
Guide couverts	180
Guide taille vêtements	518
Guide vaisselle	10
Guide verrerie	134
Guillotines à saucissons	105

## H

H2O bouteille	219
Habana verrerie	161
HACCP coutellerie	420
Hachoirs à viande	360
Hachoirs berceuses	425
Hachoirs réfrigérés	360
Haiku coutellerie	418
<b>Hall / Extérieur</b>	<b>534, 535</b>
Harmonia verrerie	173
Hawai verrerie	170
Heat system vaisselle	97
Helsinki verrerie	165
Héritage couverts	203
Héritage verrerie	170
Highlight photophores	222
Holi vaisselle	17
Honey verrerie	165
Hôtel vaisselle	89
<b>Hôtellerie</b>	<b>495 à 535</b>
Housses literie	528
Housses pour collecteurs	497
Housses pour chariot et échelles	343
Housses pour trancheurs	359
Huiliers	236
Huître couteaux	104
Hurricane verrerie	170
Hygiène des mains	489
<b>Hygiène et entretien</b>	<b>468 à 499</b>
Hypinox	119, 216

## I

Ibis verrerie	216
Ice bag	231
Impulse vaisselle	57, 104
Incassables verrerie	174
Ingres couverts	199
Insecticide pour volants / rampants	492
Intemporel vaisselle	84

Intensity vaisselle	90, 103
Irish coffee verrerie	133
Isi pochettes serviettes	305
Islande verrerie	124, 126
Izia couverts	193

## J

Java verrerie	133
Jazz vaisselle	50
Jazz verrerie	177
Jazzed verrerie	177
Jockey Club verrerie	170
Jumbo coutellerie	102, 202
Jungle vaisselle	65
Jupes femmes	511
Juponage	285

## K

K vaisselle	88
Kali pèle-pomme	429
Karbon vaisselle	33
Kasumi Damas coutellerie	415
Kit 7 jours	398
Kit allergènes	399
Kit couverts jetable	307
Kit de dépolluissage	481
Kit de lavage à plat	482
Kit enfant restaurant	291
Kit pour armoire à pharmacie	492
Kit plateaux repas	310
Kit protection four	498
Kit visiteurs	499
Konik porcelaine	219
Krysta verrerie	136 à 143
Kube verrerie	124
Kyoto verrerie	170

## L

Laguiole coutellerie	203
Laitière	379
Lames gélosées	399
Lampe infrarouge	393
Lampe pour chevalets	227
Lavage espagnol	483, 484
Lave-mains à dosseret	338
Laverie casiers	350
Lavettes hygiène	481
Lazzo couverts	187
Legging femme	513
Légumiers inox	268
Légumiers mélamine	273
Léo soupicières	115
Lessive	479
Likid vaisselle	58
Lima verrerie	156, 164
Limonadiers	238, 239
Linéal verrerie	147
Linely verrerie	164
Linelys nappage textile	281
Linen vaisselle	75
Lingettes désinfectantes	474

Liquide de lavage machine	470
Liquide de rinçage machine	471
Liquide de trempage	472
Liquide lave-verres	470
Liquide vaisselle	472
Lisah usage unique	294
Liteaux	237, 512
<b>Literie hôtellerie</b>	<b>528, 529</b>
Log verrerie	161
Londres vaisselle	117
Louches	434, 435
Louchette à pizza	453
Louchettes	276
Louison vaisselle	93
Lounge verrerie	165
Lumi Art photophores	220
Lupo coutellerie	204
Lyon verrerie	161
Lyres	428

## M

Macaron verrerie	139, 171
Macaron Fascination verrerie	171
Macassar verrerie	138, 172
Machine à pâtes	453
Machines à café	380, 381
Machines sous vide	392
Maeva verrerie	179
Magily nappage textile	281
Maintien au chaud (lampe)	393
Maintien en température	387
Maléa verrerie	156
Malinette	458
Mallette de barmen	235
Mallette de coutellerie	425
Manches balais	482, 483
Mandolines	430, 431
Manne à pain	355
Manne osier / polypropylène	263
<b>Manutention et stockage</b>	<b>352 à 357</b>
Margarita verrerie	170
Marmelette	113
Marmite à jus	121
Marmites	402, 403
Marmites à moules	104
Marmites à soupe	266
Martignes verrerie	169
Mason salière/poivrière	212
Masques papier	498
Matcha vaisselle	83
<b>Matériel de bar</b>	<b>230 à 239</b>
<b>Matériel de cuisine</b>	<b>401 à 455</b>
<b>Matériel de cuisson</b>	<b>382 à 393</b>
<b>Matériel de nettoyage</b>	<b>480 à 485</b>
<b>Matériel électrique</b>	<b>358 à 381</b>
Max verrerie	178
Mazza vaisselle	31
Mealplak vaisselle	59
Médart de Noblat vaisselle	12, 13
Mekkano vaisselle	91
Ménagères	212, 213
Mesures étain, inox	236
Mesures graduées cuisine	441
Métal fusion vaisselle	27
Métropolis vaisselle	45
Meuble poubelle	494

<b>Meubles inox</b>	<b>336 à 338</b>
Michelangelo verrerie	144, 216
Mignardises cuivre / inox / fonte	118, 119
Mignardises jetables	312
Mignardises miniportion	125
Mignardises monoportion	123
Mignardises porcelaine	121
Mignardises verre	123
Millassons moule	448
Millenium couverts	186
Milord verrerie	178
Mini cocottes	119, 408, 409
Mini-mixers	368
Minuteurs chronomètres	397
Miroirs hôtellerie	524
Mises en bouche jetable	311 à 314
Misura verrerie	217
Mix and Co verrerie	163
Mixers / Combi mixers	367 à 370
Mixers de bar	375
Mixing glass	232
Mobilier Intérieur / Extérieur	6, 7
Mocassins	515
Modern Grace vaisselle	21
Monobrosse	485
Montmartre vaisselle	49
Moon vaisselle	45
Mosaic photophores	222
Moscow Mule verrerie	166
Mouchoirs	525
Moufle anti-chaleur pro	426
Moule à cake	450
Moule à dariole	448
Moule à galantine	113
Moule de cuisson bois	325
Moules à pâtés	450
Moules à pâtisserie	449
Moules cuisson bois	325
Moules œuf en gelée	320
Moules silicone	447
<b>Moulins à sel / poivre</b>	<b>208 à 211</b>
Moulins cuisine	441
Moutardiers	213
Moving vaisselle	67
Mugs caféterier	132

## N

Nancy moulins à sel/poivre	210
Nano vaisselle	38
Napoli verrerie	151
<b>Nappage jetable</b>	<b>288 à 297</b>
<b>Nappage textile</b>	<b>278 à 285</b>
Nappes au format	292, 293, 296
Nécessaire à givrer	232
Nectar vaisselle	130
Neo Fusion vaisselle	28, 29, 106
Néon led	221
Nettoyant bois	478
Nettoyant vitres	478
Neuvième Art couverts	185
New D Light photophores	222
New Kalix verrerie	147, 156
New wave vaisselle	25
New york verrerie	168
Nonic verrerie	173
Normandie verrerie	148

Norvège verrerie	161
Note de traçabilité alimentaire	398
Nova ménagères	213
Noyaux de cuisson	444
Numéros de vestiaires	534

## O

Oak planches	248
Octave couverts	200
Odorisants	477
Œnologue expert verrerie	141, 171
Officina 1825 verrerie	156, 219
Okito vaisselle	81
Olive planches	248
Onde vaisselle	12
Ondine vaisselle	42
Ondine coupe dessert	179
Onyx photophores	220
Onyx verrerie	149
Opal nappage textile	278
Open Up Arabesque	138, 154
Open Up Spirit	172
Open Up verrerie	137, 216
Optima huilier	214
Optima vaisselle	89
Optima verrerie	219
Oreillers	528
Orenok couverts	193
Organiseur clear box	398
Oséo saladiers	179, 272
Oslo caféterier	133
Ouessant verrerie	155
Ouvre-boîtes	433
Oxygène plateaux	267
Oxygène verrerie	161

## P

Pailles / chalumeaux	175
Pailles en verre	233
Palette de présentation	311, 314
Palette de stockage	357
Palmier verrerie	177
Panières	284
Paniers à friture	102
Paniers à pains / viennoiseries	263, 284
Paniers vapeur	104
Panneaux d'avertissement	484
<b>Pantalons cuisine</b>	<b>503, 507</b>
<b>Pantalons de service</b>	<b>511, 512</b>
Papaya saladier	272
Papier de cuisson	455
Papier ingraissable	207, 316
Papiers alimentaires	102
Papiers hygiéniques	490, 491
Paris moulins à poivre/sel	208, 209
Parts de tarte	323
Parts pizza	318
Partyclips	308
Passe-bouillons	440
Passoires à cocktail	232
Passoires à pâtes	407
Passoires de cuisine	440
Pasta passion vaisselle	22
Pastilles de chlore	475

Pastilles de lavage	470	Plancha vaisselle	102	Porte-affiche fenêtre	227
Pâte à polir cuivre	472	Planche à fromage	248	Porte-bagage	531
Patères	523	Planche à pain	207	Porte-balayette	526
<b>Pâtisserie matériel</b>	<b>444 à 452</b>	Planches à découper	427	Porte-bouteilles	262
Paula cafétéria	132	Planches bois	248, 249	Porte-clés	534
Peignoirs	527	Planchetta de table	105	Porte-cuillère	128, 235
Peinture ardoise	226	Plaque en tôle	453	Porte-étiquettes	265
Pèle-pommes	429	Plaques à débarasser	441	Porte-plateau	104, 239
Pelle à frites	386	Plaques à induction	266	Porte-roll's	425
Pelle à omelette	434	Plaques à induction / Wok	389	Porte-sac	494
Pelle à pizza	453	Plaques à rôtir	407	Portes-agrumes	237, 262
Pelle à poisson	434	Plaques à tuiles	443	Porte-savon	522
Pelle de cuisson	435	Plaques anti-adhésives	442	Porte-seau à champagne	230
Pelle nettoyage	483	Plaques pour conteneurs	460, 462	Porte-serviettes	523
Pelles à ingrédients	444	Plaques chauffantes	266	Porte-visuel	226
Penderie cuisine	434	Plaques en aluminium	442	Portionneuses à glace	176
Penderies mobile	534	Plaques perforées	442, 453	Pose-plateaux	239
Pep's moulins à poivre/sel	211	Plaquettes de chambre	531	Pot à cornichons	113
Pépité verrerie	179	Plat à poisson	268	Pot à jus	121
Percolateurs	379	Plateau isotherme Tablotherm	458, 460	Pot à sauce jetables	318, 321
Perigord verrerie	173	<b>Plateaux</b>	<b>240 à 245</b>	Pot lyonnais	236
<b>Photophores</b>	<b>220 à 222</b>	Plateaux à fruits de mer	104	Poteaux hôtellerie	534
Photophores à led	220	Plateaux de service	239	Pots à desserts	319
Picardie verrerie	133, 272	Plateaux effet ardoise	253	Pots à lait	132
Pichet Jazz isotherme	267	Plateaux gourmands	127	Pots à pâtes	318
Pichets	215 à 217	Plateaux repas	310	Poubelle à papier	494
Pichets à pompe	267, 381	Plateaux room service	530	Poubelles à pédale	493 à 495
Pichets antibactérien	215	Plateaux traiteur	268, 311	Poubelles d'immeuble	497
Pichets doseur	482	Platerie de cuisson et service	409	Poubelles de chambre	531
Pichets en polypropylène	215, 267	Platerie inox	268	Poubelles snacking	494
Pichets en polyuréthane	267	Platerie mélamine	270, 271	Poudre de lavage machine	470
Pichets et verseuses isothermes	215, 381	Platerie porcelaine	268, 269	<b>Préparation cuisine</b>	<b>415 à 432</b>
Piccolo photophore	221	Plats à cake	111	Présentation pour buffet	253 à 264
Pics steak	102	Plats à gratin	268	Présentoir Big GN	261
Pied pour réchaud plat paëlla	407	Plats à lasagnes	113	Présentoir King	274
Pierres à aiguiser	423	Plats à oreilles	120	Présentoirs à céréales	262
Pili Pili verrerie	126	Plats à paëlla	407	Présentoirs à pâtisserie	253
Pillivuyt vaisselle	47 à 50	Plats à poisson	104, 268	Présentoirs à pièce montée	445
Pilons	235	Plats acrylique	251	Présentoirs pour buffet	253
Pinceaux pâtissier	445	Plats en fonte	119, 409	Presse universelle	484
Pinceaux silicone	445	Plats et barquettes aluminium	324	Presse-agrumes	235
Pincés à arêtes	424	Plats fonte ovale	409	Presse-agrumes électriques	376
Pincés à escargot	114	Plats inox	114	Presse-citron	104
Pincés à gâteau	277	Plats sabots	112, 113	Presse-fruits sur pieds	237
Pincés à glaçons	233	Playa vaisselle	42	Presse-purée	369
Pincés à pain	277	Playtime mignardises	120	Primarific verrerie	159
Pincés à salade	277	Poches jetables	445	Primary verrerie	155
Pincés à servir	277	Poches nylon	445	Princesa verrerie	148, 156
Pincés à spaghetti	277	Pochettes couverts	304, 305	Priority batterie de cuisine	401
Pincés anti-microbien	276, 439	Pochettes frites	321	Prismo cafétéria	116, 129
Pincés de dressage	439	Pochons	434, 435	<b>Produits d'accueil</b>	<b>520</b>
Pincés feuille de chêne	439	<b>Poêles</b>	<b>401, 405</b>	<b>Produits d'entretien</b>	<b>470 à 492</b>
Pincés jupe / pantalon	531	Poêles wok	405	Pro.mundi couverts	192 à 198
Pincés nappe	285	Poêlons	114	Pro.mundi vaisselle	73 à 92
Pincés plats chauds	411	Poêlons à sucre cuivre	446	Profile coutellerie	203
Pincés-étiquettes	265	Poignées scotchbrick	480	Protection anti-coupure	426
Pincés-sac	494	Poignées Timon	355	Protège-matelas	529
Pinta verrerie	123	Poissonnières	407	<b>Protèges-menu</b>	<b>225</b>
Pintinox couverts	194	Polaires vêtements	514	Protèges-tables	285
Pipette pour verrines	312	Pom Pom verrerie	126	Prysm verrerie	169
Piques bigorneaux	104	Pompe à savon	522	Pure saladiers	273
Piques bois	126 à 315	Pompe à sirop pour bouteille	236	Purity vaisselle	14
Piques mignardises	315	Pontarlier moulin à poivre/sel	210	Pyrex plats	112
Pixelle 3D couverts	186	Porte brochettes	102		
Pizza matériels	453	Porte menus extérieurs	228, 229		
Pizza assiettes vaisselle	103	Porte-accessoires bar	234		
Planchas électriques	385	Porte-addition	234		

## Q

Quadra vaisselle	68
Qualicoup couteaux de cuisine	421
Qualiplus batterie de cuisine	402
Quartz verrerie	125, 172
Quattro stagioni	166, 219

## R

Rack porte-outils mural	439
Raclette coupe-pâte	444
Raclettes brosseuse	482
Racloirs	427
Rafraîchisseur inox	230
Rak vaisselle	27 à 45
Ramasse couverts	205
Ramasse miettes	207
Ramequin	268 à 324
Rampe chauffante infrarouge	393
Range couverts	205
Râpe à truffe	431
Râpes	428
Rase-tout	429
Râteau à crêpe	388
Raviers usage unique	320
<b>Rayonnage</b>	<b>332 à 335</b>
Réception / Salle de bain	520
Recherche torchons	487
Recharge huile	221
Recharge papier hygiénique	490
Recharge savon	489
Réchauds	105, 265, 407
Récurage produits d'entretien	480
Rendez-vous verrerie	163
Rénovateur produits d'entretien	472
Restaurant vaisselle	95
Resto verrerie	149
Revol vaisselle	53 à 58
Reveal Up verrerie	136, 171
Révolution vaisselle	110
Rideau de douche	527
Rim vaisselle	80
Rio porte menus	225
Ripple vaisselle	65
Riviera couteaux de cuisine	418
Robots de cuisine	374
Robots multi fonctions	371
Rock Bar verrerie	160
Roll's	425
Roller pâte	444
Roma Color vaisselle	84
Roma vaisselle	88
Rond festonné blanc	311
Rondo vaisselle	45
Room service plateaux	240, 53
Roquefortaises	428
Rouleaux à pâtisserie	444
<b>Rouleaux de nappe jetable</b>	<b>293 à 297</b>
<b>Rouleaux de nappe PVC</b>	<b>283, 285</b>
<b>Rouleaux de tête à tête</b>	<b>292 à 295</b>
Rouleaux Jumbo	491
Rouleaux mini Jumbo	491
Rouleaux molleton PVC	285
Rouleaux pic-vite	444
Roulettes à pâte	444

Roulettes pizza	453
Royal couteau	202
Rubino verrerie	145
Rubis couverts	183
Ruby vaisselle	88
Rustic Riser buffet	255

## S

Sabots	517
Sacs prélèvement	398
Sacchetto Airlaid nappage unique	305
Sacs à bouteille	328
Sacs bretelle	328
Sacs cabas	328
Sacs congélation	398, 455
Sacs de cuisson	392
Sacs échantillonnage plats témoins	398
Sacs fast food	328
Sacs isotherme	318
Sacs poubelle	497
Sacs sandwich	317
Sacs sous vide	392
Sacs viennoiseries	317
Saladiers copolyester	275
Saladiers en mélamine	273 à 275
Saladiers en verre	272
Saladiers inox double paroi	275
Salamandres	384
Salières / Poivrières	211 à 213
Salto Color verrerie	159
Salto verrerie	126, 156
Sambaya verrerie	170
Sand vaisselle	64
Sandwich sacs	317
Santiano pichets	217
Saphir vaisselle	79
Sarat matt nappage textile	279
Satellite verrerie	165
Saten nappage textile	278
Satinique vaisselle	22, 23
Saucières	115
Saupoudreuses	103, 444
Sauteuses	401 à 405
Sauteuses fonte	408
Savarins moules	448
Savoie verrerie	151
Savon à mains	489
Savon d'hôtellerie	520, 522
Savor vaisselle	14
Scelleuses et barquettes scellables	327
Scies de boucher	425
Scotch verrerie	169
Season's bar saladiers	272
Seaux à bouteilles	230, 231
Seaux à glaçons	230, 231
Seaux avec presse	485
Seaux de lavage	481
Sèche-cheveux	524
Sèche-mains	489
Sedona vaisselle	24
Seille à patates	105
Seilles régénérant	471
Semelles cuir	517
Sensation Exalt verrerie	143
Séparation isotherme Thermobarrier	462

Serax vaisselle	71
Serpillières	484
Service à foie gras	428
Service à fondue	105
Serviettes cocktail	303
Serviettes enchevêtrées	302
Serviettes éponge	527
Serviettes Lisah	301
Serviettes non tissé	299 à 303
Serviettes ouate	302
Serviettes rafraîchissantes	104, 520
<b>Sets nappage</b>	<b>284 à 297</b>
Sets réfrigérés	256 à 262
Settecento couverts	194
Shaker bar	232, 233
Shaker sel	208 à 210
Shark couteau	203
Shetland verrerie	125, 169
Shoreline	101
Siena ménagères	213, 214
Silhouette ardoise	265
Siphon à chantilly	445
Ska vaisselle	44
Skailys nappage textile	280
Skull cocktail	167
Sky vaisselle	73
Slate vaisselle	64
Slim O vaisselle	131
Smoothie gobelets jetables	308
Snack mélamine	263
Snack vaisselle	68
Socle porte-fiches	329
Socle rouleur	352, 462
Soft glow bougies	222
Solid vaisselle	58
Sonnette de comptoir	534
Sonoclean nappage textile	282, 283
Soup passion vaisselle	22
Soupières	268, 312
Sous verre	173
Spatules	435 à 438
Spatules à crêpe	388
Spatules à raclette	105
Spatules bois	438
Spécial Paëlla	407
Spécial vin au verre	153
Speed Cup Shaker	233
Sphère à moules	68
Spirit coupe à desserts	178
Splash vaisselle	61
Spoon couverts	188
Spray anti calcaire	477
Spray dégraissant	473
Spray démouleur	452
Spray détachant textile	479
Spray huile/vinaigre	103
Spray nettoyant craie waterproof	226
Spray nettoyant sanitaire	476
Spray nettoyant surfaces et sols	475
Spray vitres	474
Spunbond nappage	295
Spunlace serviettes	300
Stack Up verrerie	126, 168
Stacky Oxygen verrerie	161
Stairo vaisselle	96
Stand Star buffet	254
Steak couteaux	204



Stella coupelle	272
<b>Stockage et manutention</b>	<b>352 à 358</b>
Stockholm verrerie	169
Stone vaisselle	13
Stop glisse	436, 437
Stratifiés plateaux	241
Style 180 couverts	198
Style ethnic vaisselle	66
Style vaisselle	66
Sublime carafe	219
Sublime vaisselle	14
Sublym verrerie	141, 171
Succession vaisselle	53
Sucrier boule	128
Sun lave vaisselle	470
Sunday coupe à desserts	178
Superbox buffet	261
Support anti-dérapant	101
Support doseur	236
Support mural porte balayette	526
Support pour lavage à plat	484
Support sac poubelle tri sélectif	495
Surchaussures	499
Surface vaisselle	71
Sweet coupe à desserts	179
Swing verrerie	123, 219
Switty serviettes	304

## T

T Glass verrerie	145
Tables inox	336, 338
Tablettes lave vaisselle	470
Tabliers	508 à 510
Tabliers barman	512
Tabliers polyéthylène	499
Tabliers sommelier	237, 509
Tabourets d'hôtellerie	524
Tags ardoises	265
Tahiti coupe à desserts	178
Taies pour oreiller/traversin	528
Taillanderie	425
Tajine plats	114
Tamis	446
Tamponges	480
Tampons abrasifs	480
Tapis	535
Tapis de bain	527
Tapis de bar	232 à 234
Tartelettes moules	448
Tarrerias couverts	201
Tavern verrerie	170
Teck vaisselle	48
Tendency vaisselle	90
Terrines foie gras	112
Testeur d'huile	399
Tête à tête en rouleau	292 à 295
Tête de lion vaisselle	115
Textile d'hôtellerie	527
Thermax conteneurs	464
Thermobox conteneurs	459
<b>Thermomètres</b>	<b>396, 397</b>
Thermoplongeurs	393
Thermos	267
Tiki verrerie	166
Tire-bouchons	238

Tivoli verrerie	217
Toasters	382
Toiles de cuisson	443
Toques	498, 508
Toqueur à œuf	428
Torcello verrerie	272
Torchons jetables	487
Torchons tissu	508
Toulouse vaisselle	113
Tour eiffel salière/poivrière	212
Tours de cou	508
Tourtières	324, 449
<b>Traçabilité alimentaire</b>	<b>398, 399</b>
Trancheur à pain	361
Trancheurs	358, 359
<b>Transport de repas</b>	<b>458 à 465</b>
Traversin taies	528
Tre Sensi verrerie	146
Tren produits d'hôtellerie	520, 521
Trilogy couverts	198
Trousse pour couteaux	425
Tuniques femme	513
Tutti saladiers	83
Twice cafétéria	123, 133
Twiggy corbeilles	207
Twin verrerie	157
Twins vaisselle	81

## U

Ultimate Pint verrerie	173
<b>Univers pizza</b>	<b>453</b>
Uno verrerie	146, 171
Up & Go salière/poivrière	212
<b>Usage unique</b>	<b>288 à 329</b>
Ustensiles buffet	277
Ustensiles de cuisine	434 à 439
Ustensiles de pâtisserie	444
Ustensiles Stop glisse®	436, 437
Ustensiles Surglass®	437

## V

<b>Vaisselle</b>	<b>10 à 126</b>
Vaisselle culinaire	106 à 117
Vaisselle de spécialités	102 à 105
Vaisselle en mélamine	98
Vaisselle en Opal	94 à 96
Vaisselle en verre	92, 93
Vaisselle enfant	99
Vaisselle incassable	98 à 101
Vaisselle produits d'entretien	470 à 472
<b>Vaisselle régithermie</b>	<b>97</b>
Vaisselle thermodynamique	101
Vaporisateurs	481
Vasques à bouteille	230, 231
Vega coupes dessert	179
Veilleuses bougies	222
Veloutée vaisselle	92
Vendôme vaisselle	50
Vénécia verrerie	158
<b>Vente à emporter</b>	<b>316 à 328</b>
Vénus vaisselle	89
Véronèse verrerie	164
<b>Verrerie</b>	<b>123 à 179</b>

Verres cocktail	170
Verres copolyester	174
Verres jetables	308
<b>Verrines</b>	<b>120 à 125</b>
Verseurs à vin	237
Verseuses	381
Vertigo verrerie	123
Vestiaire	492
<b>Vêtements de Cuisine</b>	<b>502 à 517</b>
Vêtements de Service	511, 512
Vêtements de travail	513, 514
Vide-pomme	429
Vieux Paris couverts	200
Vieux Paris PM couverts	196
Vigne	164, 172
Villeroy & Boch vaisselle	21 à 25
Vin au verre verrerie	153
Vina verrerie	151
Vinaigriers	213, 214
Vino classico carafe	216
Vintage Linus usage unique	290
Vintage vaisselle	30
Vital vaisselle	61
Viticole verrerie	150, 153
Vitres produits d'entretien	478
Viva carafe	217
Volette pâtisserie	444
Volubis verrerie	178
Voluto cafétéria	133
Votive photophores	222

## W

Water Pearl vaisselle	15
Wave Ciselé couverts	192
Wave couverts	192
Wave saladier	275
Wave vaisselle	98
Wibox vins	238
Wikeeps vins	238
Wing vaisselle	87
Winter vaisselle	74
Wok	389
Woodart vaisselle	32
Wrap usage unique	321

## X

X ray coutellerie	202
-------------------	-----

## Y

Yago photophores	221
Ypsilon verrerie	124, 217

## Z

Zen Couverts	188
Zinc Cafétéria	133

**PREAMBULE**

Les présentes Conditions Générales de Vente (ci-après "CGV") constituent, conformément à l'article L 441-6 du Code de Commerce, le socle unique de la relation commerciale entre les parties.

**Tout achat réalisé ou toute commande passée auprès du Vendeur emporte adhésion sans réserve aux présentes CGV.**

Elles priment, sauf acceptation expresse du Vendeur, sur toutes conditions d'achat ou autres modalités contractuelles émanant de sa clientèle. Toute modification des présentes CGV est immédiatement applicable aux nouveaux achats ou nouvelles commandes. Il faudra entendre par « Vendeur », le franchisé ECOTEL indépendant auprès duquel l'achat ou la commande est effectuée(e). Des Conditions Générales de Vente spécifiques peuvent être applicables dans les magasins ECOTEL. Le fait que le Vendeur ne se prévale pas à un moment donné de l'une quelconque des présentes conditions générales de vente ne peut être interprété comme valant renonciation à se prévaloir ultérieurement de l'une quelconque desdites conditions.

**1 - PRODUITS / GARANTIES**

Les catalogues et documentations sont diffusés à titre informatif. Ils ne peuvent être considérés comme une offre ferme ou permanente. Les produits pourront être supprimés ou modifiés sans préavis, notamment en cas de modifications ou suppressions apportées par les fournisseurs du Vendeur. Les photographies des produits figurant dans les catalogues ont une valeur indicative et non contractuelle. Il peut exister des variations dans les dimensions, les poids et la contenance des produits et ce, en dépit du jaugage qui est purement indicatif et non garanti et qu'il appartient au client de vérifier. Sauf stipulations contraires sur le catalogue, notre garantie se limite strictement au simple remplacement de la pièce d'origine ou du produit reconnu défectueux par le fabricant. Le délai de notre garantie sera la même que celle pratiquée par le fabricant. Cette garantie exclut les avaries résultant d'une installation ou de conditions d'utilisation non conformes aux prescriptions et recommandations accompagnant chaque produit, ou d'un usage dépassant les performances prévues, ou encore, d'un manque d'entretien manifeste ou pour inadéquation du produit. En cas de réparations ou de modifications du produit effectuées par un tiers ou le client, la garantie s'annule et devient sans effet. Cette garantie tient lieu de toute autre garantie tacite, implicite, expresse ou par effet de loi.

**2 - COMMANDES**

**Les commandes sont considérées comme fermes et définitives, sauf stipulation contraire de la part du Vendeur sous 48 heures ouvrées après réception.**

Elles sont préparées immédiatement en fonction des stocks disponibles.

Les demandes de modifications, compléments, suppressions ou autres aménagements d'une commande ferme seront pris en compte dans la mesure des possibilités du Vendeur, la commande initiale demeurant valable.

Concernant les commandes spéciales (produits non suivis en stock ou personnalisés, quantité exceptionnelle...), le versement d'un acompte sera demandé au client.

Aucune annulation ne pourra être acceptée pour ce type de commande, le montant de ladite commande restant intégralement dû.

Le Vendeur dégage toute responsabilité quant aux spécifications techniques, caractéristiques et références stipulées par le client à l'occasion de la passation de la commande dans l'hypothèse où elles s'avèreraient inadéquates ou fausses.

**3 - PRIX**

**Les prix sont toujours exprimés hors taxes, départ des entrepôts du Vendeur, TVA en sus, suivant le tarif en vigueur au jour de la commande.** Nos prix figurent sur nos tarifs à disposition de la clientèle en magasin ou au siège de la société. Lesdits prix étant fonction des marchés qu'il est possible au Vendeur de passer avec ses fournisseurs, il se réserve la possibilité de les modifier. Le client pourra bénéficier de rabais, remises et ristournes de la part du VENDEUR, en fonction des quantités acquises ou livrées par le VENDEUR en une seule fois et un seul lieu, ou de la régularité de ses commandes. Nos prix s'entendent sous réserve de modifications liées à l'application de toute nouvelle éco-taxe telle que celle prévue pour les coûts d'élimination des éléments d'ameublement.

**4 - LIVRAISONS ET TRANSFERT DES RISQUES**

**4.1 - Livraison** La livraison est effectuée soit par la remise matérielle directe des produits au client (en magasin ou suite à livraison par le Vendeur), soit par la délivrance des produits à un transporteur mandaté par le client ou par le Vendeur. Dans ce dernier cas, le client reconnaît que c'est au transporteur qu'il appartient d'effectuer la livraison, le Vendeur étant réputé avoir rempli son obligation de délivrance dès lors qu'il a remis les marchandises au transporteur. Le client ne dispose d'aucun recours en garantie contre le chargeur, fût-il le Vendeur en cas de défaut de livraison. Les délais de livraison du Vendeur sont donnés à titre indicatif.

Le Vendeur s'efforce de les respecter scrupuleusement, cependant, tout retard de livraison ne pourra engager sa responsabilité, ni donner lieu à dommages et intérêts, à retenue ou annulations de commandes. En toute hypothèse, la livraison dans les délais ne pourra intervenir que si le client est à jour de ses obligations envers le Vendeur. Concernant les commandes spéciales et/ou les commandes d'articles personnalisés ainsi que les articles hors catalogue, elles seront sujettes à un délai de livraison supérieur aux conditions habituelles et ne feront l'objet d'aucune reprise. Le Vendeur informe le client que les ventes sont conditionnées par la disponibilité des produits chez les producteurs. En conséquence, la non-disponibilité des produits chez le producteur et l'épuisement des stocks sont des causes de résiliation partielle de la commande. En cas de livraison, à réception des produits, le client s'engage à remplir les principales obligations suivantes : (a) se faire présenter les documents de livraison et s'assurer que l'envoi lui est bien destiné, (b) vérifier le nombre de colis et l'état des produits, (c) accepter la livraison dès lors que les produits sont conformes à la commande (même s'il y a des dommages), en signant lisiblement le bon de livraison ou le récépissé de transport et en y ajoutant le cachet de son établissement et son nom en lettres capitales, (d) en cas de dommages, formuler des réserves précises sur le récépissé original du transporteur (lesdites réserves devront être datées et signées) des réserves qui ne sont pas recevables des réserves qui ne sont pas significatives, claires et complètes : ainsi les mentions « sous réserve de déballage » ou « sous réserve de casse » n'ont aucune valeur. Il est nécessaire de dater et de signer les réserves, (e) confirmer ces réserves sous trois jours ouvrables par lettre recommandée adressée au transporteur. Sans préjudice des dispositions à prendre vis-à-vis du transporteur, les réclamations sur les vices apparents ou la non-conformité des produits livrés devront être formulées par écrit auprès du Vendeur dans les huit (8) jours de la livraison desdits produits. A défaut de réclamations formulées dans ce délai, les produits livrés seront réputés conformes en quantité et qualité à la commande. Tout retour devra préalablement faire l'objet d'un accord formel entre le Vendeur et le client. Toute réclamation qui serait adressée au Vendeur et qui ne respecterait pas cette procédure empêcherait le remplacement ou l'établissement de l'ivoir correspondant aux produits détériorés ou manquants.

**4.2 - Transfert des risques** La garde du produit et les risques y afférents (détérioration, perte, vol, destruction totale ou partielle, dommages pouvant être occasionnés par le produit, etc.) sont transférés au client dès la remise matérielle du produit à ce dernier, ou dès enlèvement du produit par le transporteur, ce quel que soit la cause du dommage et même s'il s'agit d'un cas fortuit ou de force majeure.

**5 - REPRISE DES PRODUITS**

Toute reprise de produits ne peut se faire sans l'accord préalable du Vendeur et aux conditions que ces produits soient livrés depuis moins de quinze (15) jours, rendus dans un parfait état de revente, qu'ils n'aient pas été utilisés et qu'ils soient restitués dans leur emballage d'origine. Le cas échéant, le retour des produits est à la charge et aux risques du client.

**6 - RESPONSABILITE**

**Notre responsabilité ne peut être recherchée pour un dommage, quel qu'il soit, relevant d'un usage anormal de nos produits. La responsabilité du Vendeur en cas de non-exécution de l'une de ses obligations contractuelles ne pourra en aucun cas, hors coût de fourniture de produits de remplacement des produits reconnus défectueux, excéder 20% du montant de la commande, à l'exception des fautes lourdes et dolosives ainsi que des dommages corporels. Ce montant convenu reflète la répartition du risque et la limitation de responsabilité qui en résulte. Le Vendeur, ne pourra être tenu responsable d'un quelconque dommage spécial, indirect ou immatériel et plus généralement à toute perte de nature économique ou financière. Le client renonce, et s'engage à faire renoncer ses assureurs, à tout recours à l'encontre du Vendeur. Le client indemnisera et tiendra quitte le Vendeur et ses assureurs de tout recours s'il ne respecte pas ou ne parvient pas à obtenir lesdites renonciations.**

**7 - FORCE MAJEURE**

Le Vendeur, ne sera pas tenu responsable de l'inexécution de ses obligations aux termes des présentes (à savoir les livraisons des produits ou l'exécution normale de la vente), ni de tout dommage en découlant, pour cas fortuits ou force majeure tels que définis par les cours et tribunaux français comme étant un événement dont le Vendeur ne peut raisonnablement avoir la maîtrise. Etant précisé que seront considérés comme cas fortuits ou de force majeure au titre des présentes CGV, sans que cette liste ne soit limitative, un incendie, une explosion, une inondation, ou catastrophe naturelle, les guerres ou actions du personnel des fabricants, fournisseurs ou sous-traitants, émeutes, épidémies, acte de terrorisme, l'interruption totale ou partielle des transports ou leur ralentissement, la pénurie de matières premières, ou de l'énergie, les incidents et accidents et toutes causes entraînant le chômage de tout ou partie du personnel des fabricants ou fournisseurs, un retard de livraison des fabricants, fournisseurs ou des sous-traitants, une mise en conformité avec de nouvelles lois ou réglementations, un embargo, évolution imprévisible du marché, rupture de stocks etc.

En ce cas, si l'événement venait à durer plus de 30 jours, le Vendeur pourra suspendre ou résilier le contrat entre les parties. La force majeure ne suspend pas le paiement des produits déjà livrés. La force majeure exclut pour le débiteur toutes pénalités de retard et autres dommages et intérêts.

**8 - CONDITIONS DE RÈGLEMENT**

Le Vendeur se réserve la possibilité d'exiger à ses clients le versement d'acomptes.

**Les factures émises par le Vendeur sont payables comptant à leur réception.**

Aucune retenue de quelque nature que ce soit ne peut être effectuée par le client sur les règlements destinés au Vendeur. Sans préjudice de la faculté, pour le Vendeur, de faire valoir la clause de réserve de propriété stipulée dans les présentes CGV et toute autre action qu'il serait en droit d'intenter, tout retard de paiement donnera lieu, de plein droit et sans mise en demeure préalable, au paiement d'une pénalité de retard dont le taux d'intérêt s'élèvera à 1% par mois. Ces intérêts courront du lendemain de l'échéance jusqu'au paiement complet. Ils seront exigibles sur simple demande. Tout retard de paiement donnera lieu également, de plein droit et sans notification préalable, au paiement d'une indemnité forfaitaire pour frais de recouvrement, d'un montant de 40 euros. Le Vendeur se réserve le droit de demander au client une indemnisation complémentaire si les frais de recouvrement effectivement engagés dépassaient ce montant, sur présentation des justificatifs. De convention expresse, en sus de ce qui précède, le défaut de paiement des produits à l'échéance fixée, entraînera l'exigibilité immédiate de toutes les sommes restant dues par le client au Vendeur et l'application, à titre de clause pénale, d'une indemnité conventionnelle égale à 20% du montant total de la commande en cause. En cas de non-respect des conditions de paiement figurant ci-dessus, le Vendeur se réserve en outre le droit de suspendre la livraison des commandes en cours de la part du client ou d'annuler les éventuelles remises accordées à ce dernier.

**9 - CLAUSE DE RÉSERVE DE PROPRIÉTÉ**

**Le Vendeur conserve la propriété des produits vendus, tant à l'égard du client, qu'à l'égard des créanciers de celui-ci ou des tiers, jusqu'au paiement effectif de l'intégralité du prix, en principal et accessoires. Ne constitue pas un paiement, la remise de traites acceptées ou d'autres titres créant une obligation de payer, la créance origininaire du Vendeur subsistant avec toutes les garanties qui y sont attachées, y compris la réserve de propriété. Le défaut de paiement intégral à l'échéance convenue pourra entraîner, dès le lendemain de ladite échéance, la revendication des produits par le Vendeur, la restitution par le client devant être immédiate et lesdits produits devant être livrés aux frais, risques et périls du client. Dans cette hypothèse, les sommes éventuellement versées par le client resteront la propriété du Vendeur. Ces dispositions seront notamment applicables en cas de procédure de sauvegarde, de redressement ou de liquidation judiciaire.**

Le Vendeur pourra en outre réclamer au client des sommes complémentaires, égales aux frais engagés dans le cadre du retrait des produits, majorées des intérêts et indemnités prévus au paragraphe 8.

Sauf à engager sa propre responsabilité, le client s'engage à immédiatement informer le Vendeur, par écrit, de la saisie éventuelle des produits ou de toute autre intervention d'un tiers.

Jusqu'au paiement complet, le client ne pourra disposer des produits, les revendre, les transformer, les donner en gage ou les céder à titre de garantie.

En cas de revente ou de transformation par le client des produits restés impayés, la réserve de propriété sera de plein droit transférée sur le prix des produits vendus et facturés par lui à sa clientèle (sous-acquéreur).

Le Vendeur disposera en ce cas du droit de notifier au sous-acquéreur sa réserve de propriété et de pratiquer toutes mesures d'exécution en vue du paiement direct des sommes lui restant dues.

**10 - PROPRIÉTÉ INTELLECTUELLE**

Le Vendeur conserve l'ensemble des droits de propriété industrielle et intellectuelle afférents à son nom commercial, sa marque, aux produits, photos et documentations techniques qui ne peuvent être communiqués ni exploités sans son autorisation écrite.

**11- DROIT APPLICABLE - ÉLECTION DE DOMICILE ET DE JURIDICTION**

Les présentes CGV sont régies par le droit français.

L'élection de domicile du Vendeur est faite en son siège social.

**TOUS LITIGES, QUELLE QU'EN SOIT LA NATURE, SERONT TRANSMIS AU TRIBUNAL DE COMMERCE DU LIEU DU SIÈGE DU VENDEUR, AUQUEL IL EST FAIT EXPRESSEMENT ATTRIBUTION DE JURIDICTION.**



# Nos 5 engagements



Offre produits plus respectueuse de l'environnement



Relations durables avec nos partenaires



Meilleure maîtrise de notre impact sur l'environnement



Promouvoir une plus grande responsabilité en matière d'environnement



Promouvoir des relations sociales équitables



This is our **Communication on Progress** in implementing the principles of the **United Nations Global Compact**.

We welcome feedback on its contents.



**Choisissez**  
votre magasin



**Réservez**  
en ligne



**Retirez**  
en magasin

- 02 Bastia** - VILLO CONCEPT  
LD Campo Valone - ZI Tragone 2B 20620 BIGUGLIA  
Tél. 04 95 48 57 96  
corse@ecotel.fr
- 03 Vichy** - CADRAGE DEBORD  
38 avenue de la Croix Saint Martin 03200 Vichy  
Tél. 04 70 32 34 46 - Fax 04 70 32 66 43  
vichy@ecotel.fr
- 05 Gap** - FRIGELEC ZA de la justice  
2, rue de la Boiserie - 05000 GAP  
Tél. 04 92 51 50 53 - Fax : 04 92 53 77 42  
gap@ecotel.fr
- 06 Nice** - SO.NI.VA. Société Niçoise de Vaisselle  
23 bld Fuon Santa  
06340 NICE - LA TRINITÉ  
Tél. 04 93 89 20 57 - Fax : 04 93 26 98 22  
nice@ecotel.fr
- 07 Aubenas** - MATAL  
2, rue Ampère-ZI de Bellande - 07200 AUBENAS  
26320 ST. MARCEL LES VALENCE  
Tél. 04 75 35 24 98 - Fax : 04 75 35 10 23  
aubenas@ecotel.fr
- 10 Troyes** - Ecotel Troyes  
Marché des Ecrevoilles - Rue des Tirverts  
10150 Pont Sainte Marie  
Tél. 03 25 80 77 60 - Fax : 03 25 80 26 48  
troyes@ecotel.fr
- 12 Rodez** - AVEYRON EQUIPEMENT HÔTELLIER  
32 rue des Orfèvres ZA Bel Air - 12850 Onet le Chateau  
Tél. 05 65 67 40 40 - Fax : 05 65 69 48 24  
rodez@ecotel.fr
- 13 Aix** - MORCLETTE EQUIPEMENT  
Pôle Commercial Aix Ptoline 480, rue Guillaume du Vair  
13546 AIX EN PROVENCE CEDEX 04  
Tél. 04 42 64 08 04 - Fax : 04 42 20 70 26  
aix@ecotel.fr
- 14 Caen** - SARL HEUZEY COLLECTIVITES - CHR  
3, rue des Tisserands - 14123 IFS  
Tél. 02 31 83 61 99 - Fax : 02 31 83 17 00  
caen@ecotel.fr
- 15 Aurillac** - LAYBROS  
ZI Sistrières - 47, av. G.Pompidou - 15000 AURILLAC  
Tél. 04 71 43 40 60 - Fax : 04 71 43 40 61  
aurillac@ecotel.fr
- 17 La Rochelle** - TOURS EQUIPEMENT HÔTELLIER  
8, av. Joliot Curie - 17180 PERIGNY  
Tél. 05 46 50 60 61 - Fax : 05 46 41 71 37  
larochelle@ecotel.fr
- 21 Dijon** - DUON EQUIPEMENT HÔTELLIER SAS  
28, bvd de Chicago - 21000 DIJON  
Tél. 03 80 65 39 73 - Fax : 03 80 67 75 99  
dijon@ecotel.fr
- 26 Montélimar** - LM CHR SAS  
Chemin de Fortuneau - ZI de Gourmier  
26200 MONTEILMAR  
Tél. 04 75 53 04 30  
montelmar@ecotel.fr
- 29 Quimper** - SAS PETIT PONT  
11, route de Coray - 29000 QUIMPER  
Tél. 02 98 90 42 73 - Fax : 02 98 53 07 81  
quimper@ecotel.fr
- 31 Toulouse** - PYRENEES EQUIPEMENT HÔTELLIER  
65, chemin de Fenouillet  
31200 TOULOUSE Direction : Sortie Sésquières  
Tél. 05 61 72 47 07 - Fax : 05 61 72 45 81  
toulouse@ecotel.fr
- 33 Bordeaux** - PYRENEES EQUIPEMENT HÔTELLIER  
Chemin de Labarde - 49 rue Pierre Baur  
33300 Bordeaux  
Tél. 05 57 35 00 75 - Fax : 05 57 35 00 73  
bordeaux@ecotel.fr
- 34 Montpellier** - RESTO SUD EQUIPEMENT  
Rue Claude Balbastre - Zone Périnpark - 34000 Montpellier  
Tél. 04 67 65 50 50 - Fax : 04 67 65 51 51  
montpellier@ecotel.fr
- 35 Rennes** - PROCOTEL  
Zac de la poterie - 7, rue Kerautret Botmel  
35000 Rennes  
Tél. 02 99 54 56 58 - 02 99 14 75 10  
rennes@ecotel.fr
- 37 Tours** - TOURS EQUIPEMENT HÔTELLIER  
Marché de gros Rochepinard  
Siège Social : av. Vatel - 37000 TOURS  
Tél. 02 47 44 07 77 - Fax : 02 47 44 06 09  
tours@ecotel.fr
- 41 Blois** - COMPTOIR DE LA TABLE  
ZA Croix Boissée - 6 rue Cuper - 41000 BLOIS  
Tél. 02 54 78 10 88 - Fax : 02 54 78 66 50  
blois@ecotel.fr
- 42 St Etienne** - SAINT-ETIENNE EQUIPEMENT HÔTELLIER  
26, rue des 3 Glorieuses - 42000 ST ETIENNE  
Tél. 04 77 74 22 08 - Fax : 04 77 74 21 95  
stetienne@ecotel.fr
- 43 Le Puy** - ETS MATHE LE PUY EQUIPEMENT HÔTELLIER  
47, av. Champs Elysées - CHADRAC - 43770 LE PUY EN VELAY  
Tél. 04 71 09 32 20 - Fax : 04 71 04 00 08  
lepuy@ecotel.fr
- 44 Nantes** - PROCOTEL  
375, route de Sainte Luce - 44300 Nantes  
Tél. 02 28 01 71 00 - Fax : 02 28 01 71 10  
nantes@ecotel.fr
- 45 Orléans** - FRICOM SAS  
43-45, rue Bernard Million  
45140 Saint-Jean-de-la-Ruelle  
Tél. 02 38 86 43 24 - Fax : 02 38 86 61 71  
orleans@ecotel.fr
- 50 Coutances** - OUEST EQUIPEMENT HÔTELLIER  
ZI Auberge de la Mare - BP 504 - 50205 COUTANCES CEDEX  
Tél. 02 33 76 71 05 - Fax : 02 33 76 71 08  
coutances@ecotel.fr
- 56 Vannes** - Sté RIVOAL  
67, rue du Vincin - 56000 VANNES  
Tél. 02 97 63 34 48 - Fax : 02 97 40 72 30  
vannes@ecotel.fr
- 56 Lorient** - RIVOAL LORIENT  
ZI de Kerpont - Rue Denis Papin - 56600 LANESTER  
Tél. 02 97 76 71 77 - Fax : 02 97 81 17 54  
lorient@ecotel.fr
- 59 Lille** - NORD COLLECTIVITÉS  
Zone Industrielle - 59280 BOIS GRENIER  
Tél. 03 20 77 40 64 - Fax : 03 20 77 47 16  
lille@ecotel.fr
- 63 Clermont** - CLERMONT EQUIPEMENT HOTELIER  
25 avenue de Courmon 63170 AUBIERE  
Tél. 04 73 24 42 85  
clermont@ecotel.fr
- 64 Anglet** - CÔTE BASQUE EQUIPEMENT HÔTELLIER  
Zone de Maignon - 13 rue Maryse Bastié 64600 ANGET  
Tél. 05 59 03 79 23 - Fax 05 59 55 51 26  
cotebasque@ecotel.fr
- 64 Pau** - PYRENEES EQUIPEMENT HÔTELLIER  
Rue Ampère - ZI Induspal - 64140 LONS  
Direction Hypermarché Carrefour  
Tél. 05 59 62 14 38 - Fax : 05 59 32 03 18  
pau@ecotel.fr
- 66 Perpignan** - HÔTELLERIE DISTRIBUTION  
471, av. G.Caustier Grand Saint Charles  
66000 PERPIGNAN  
Tél. 04 68 54 02 22 - Fax : 04 68 54 70 59  
perpignan@ecotel.fr
- 67 Strasbourg** - ESPACE CHR  
3, rue Edouard Branly - 67450 MUNDOLSHEIM  
Tél. 03 88 19 69 40 - Fax : 03 88 19 69 39  
strasbourg@ecotel.fr
- 68 Mulhouse** - PLAISIR DE TABLE  
158, rue d'Ilzach - 68100 MULHOUSE  
Tél. 03 89 45 23 32 - 03 89 56 18 77  
mulhouse@ecotel.fr
- 74 Annecy** - Ets Saxod- EQUIPEMENT HÔTELLIER  
71, rue de la Perollière - 74960 CRAN GEVRIER BP 422  
74020 ANNECY CEDEX  
Tél. 04 50 45 40 94 - Fax : 04 50 51 82 04  
annecy@ecotel.fr
- 76 Rouen** - E.C.R  
ZI - 63, bvd Industriel - 76300 SOTTEVILLE LES ROUEN  
Tél. 02 35 88 52 62 - Fax : 02 35 15 17 66  
rouen@ecotel.fr
- 77 Meaux** - ECOTEL MEAUX  
ZAC des Sts Pères - Rue de la Foulée  
77100 Nanteuil - Les - Meaux  
Tél. 01 60 23 98 98 - Fax : 01 64 33 53 61  
meaux@ecotel.fr
- 83 Fréjus** - FREJUS EQUIPEMENT HÔTELLIER  
ZI du Capitou - 49 rue de l'Industrie - 83600 FREJUS  
Tél. 04 94 53 72 72 - Fax : 04 94 51 22 12  
frejus@ecotel.fr
- 87 Limoges** - TOUT POUR LE FROID  
2, rue Jean Baptiste Say  
87000 LIMOGES ROMANET  
Tél. 05 55 06 19 19 - Fax : 05 55 30 88 91  
limoges@ecotel.fr
- 89 Sens** - ECOTEL SENS  
1, av. Fonderies de Pont-à-Mousson  
89100 Saint-Denis-les-Sens  
Tél. 03 86 65 45 85 - Fax : 03 86 65 91 99  
sens@ecotel.fr
- = Spécialiste mobilier**  
Parmi les franchisés qui distribuent le mobilier,  
certains ont le label de spécialistes.